



winholt
equipment®

Founded in 1946

www.winholt.com
800.444.3595

Offering You A Complete
Total Source Solution

Our Values



Founded in 1946



For Our:
Customers
Suppliers
Associates
Community

Winholt Values

For the last 68 years, Winholt has embraced the value of “caring.” Whether it is for our customers, suppliers, associates or community, we will continue to be a positive influence and model of how business should be conducted.

“We Care” is a mind-set that we have internalized in all aspects of our company.

For our customers, it is how they interact with Winholt associates and products. Each associate shares in the “We Care” philosophy, working together to create the best possible customer experience, from the time an order is placed to the delivery of our products. It is creating a long-lasting relationship between us and the customer by treating them with respect and making them feel that they are our first priority. We regard each interaction with the customer as a learning experience so we can continue to improve our service.

For our suppliers, we strive to develop two-way, mutually beneficial relationships, creating closer collaborations with them that add new value for us both. We understand our suppliers’ business and strategic goals. We are able to see issues from the supplier’s point of view and balance them with our business requirements and priorities.

For our associates, it takes the form of courtesy and respect for each team member, providing positive feedback and encouraging the sharing of ideas and suggestions. Our associates take pride in their work, constantly striving to work better and more efficiently, listening to customers and suppliers concerns.

For our community, our associates and their extended families are concerned about the neighborhoods we work and live in, as well as our environment. Winholt associates are involved in our local communities and support them through various programs and organizations, whether it is through charitable giving, volunteering time or recycling. We strive, as a family, to make our world a better place to live.



Winholt’s global manufacturing and distribution facilities offer a supply chain advantage by reducing costs and expedites delivery.

Quality Innovation Solutions Service

Our commitment to customer satisfaction positions us in the forefront of responsive innovation. Winholt's experienced team combines superior quality materials, efficient manufacturing systems and unparalleled workmanship to ensure consistent conformity to product specifications.

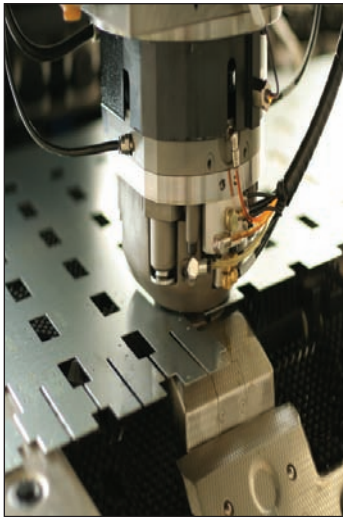

Sheet Metal Fabrication

Sophisticated 3-D Modeling System customizes products to the most precise specifications delivering superior productivity, predictability and control throughout the project life cycle.

State-of-the-art CNC Fabrication Equipment for high speed precision metal punching/cutting, improves productivity, reduces human error and provides beautifully finished equipment that can stand up to years of use.



Metal Plasma Laser cutting increases speed & accuracy

Automated Robotic Welding increases speed, quality and throughput, while assuring consistently strong welds.

Powder Coating an Eco-friendly plastic resin that is electrostatically applied and oven cured producing a hard and abrasion resistant high quality finish.



Eco-Friendly Powder Coating

Each one of our associates are focused on your satisfaction. That's our commitment to you.

Your Winholt Team!



Our skilled manufacturing associates ensure that the product you receive is always of the highest quality.



Custom Solutions



Founded in 1946

Let us design a custom solution to meet your exact requirements

Winholt offers complete engineered solutions for all your equipment requirements. Our engineering department boasts over 120 years of combined experience in equipment design and is well equipped to solve the most challenging custom applications.



Roll Cages & Distribution Carts



E-commerce Picking Cart

Meal Delivery Carts



Insulated Display Table



New York
Pennsylvania
Texas
California
China
India

Winholt's global manufacturing and distribution facilities offer a supply chain advantage by reducing costs and expedites delivery.

Efficiency Driven Solutions Custom Design

We encourage our customers to utilize our resources to design, build, and support products to meet your specific expectations, from prototype to development to full scale production. Our design team offers you the technical knowledge, expertise and capabilities that have developed concepts into foremost products for the foodservice, supermarket, retail and material handling equipment.



Insulated
Three Shelf Display



Beverage Counter

Please call us with your requirements and we can Custom Design an Efficiency Driven Solution for you!

800-444-3595

Self Serve Condiment Counter with Custom Graphics

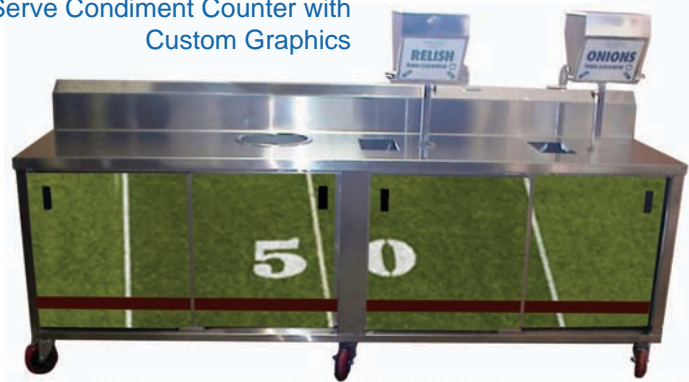

Slanted Display &
Distribution Cart





TABLE OF CONTENTS

WinFab 1-46

Custom Solutions 2
 Custom Finishes 3
 Compartment Sinks 4-11
 Sink Modifications & Diagram 12-13
 Hand Sinks 14
 Mop Sinks & Drop-in Sinks 15
 Dish Tables 16-22
 Dish Table Modifications & Diagram 22-23
 Faucets and Parts 24-25
 Work Tables, Standard 26-29
 Work Tables, Food Service & Consultant 30-31
 Enclosed Tables 32-34
 Table Modifications & Diagram 35-38
 Workstation Table Mount Shelves 39-40
 Beverage Counters 41
 Dish Cabinets 41
 Filler Tables 42
 Equipment Stands 42-43
 Wall Mounted Shelves 44-45
 Wall Mounted Pot Racks 46
 Wall Mounted Cabinets 46

Racks 47-62

Knock Down Pan Racks 48
 Pan Racks, Medium Duty 49
 Pan Rack, Heavy Duty 50
 Pan Racks 1/2 Size 51
 Universal Pan Racks 51-52
 Refrigerator Racks 53
 Channel Pan Racks 54
 Wire Pan Racks 54
 Pizza Pan Racks 55
 Donut Screen Racks 55
 Nesting Pan Racks 56
 Steam Pan Racks 56
 Stainless Steel Pan Racks 57
 Can Racks, Full Size 58
 Can Racks, 1/2 Size 59
 Can Racks, Gravity Feed 59
 Oven Racks 60-61
 French Fry Rack 62
 Cooling Rack 62

TABLE OF CONTENTS

Heater Proofer & Cabinets

63-68

Heater Proofers, Economy Non-Insulated.....	64
Heater Proofers, Standard Non-Insulated	65
Heater Proofer, 1/2 Height Non-Insulated	65
Heater Proofers, Universal Runner Non-Insulated	66
Heater Proofer, Insulated	67
Enclosed Cabinets.....	68



Transport & Mobile Storage

69-78

Queen Mary.....	70
Stainless Steel Utility Carts	71-72
Ingredient Bins.....	72-73
Sheet Pan Trucks.....	74-75
Sheet Pan Dollies	75
Cup, Glass & Plate Rack Dolly	75
Pizza Dough Box Dollies	75
Tubular Aluminum Dolly	76
Galvanized Dolly.....	76
Bussing Cart, Plastic	77
Plastic Utility Cart	77
Soiled Linen Cart.....	78
Garment Rack	78





TABLE OF CONTENTS (cont'd)

Shelving

79-92

Cantilevered Shelving..... 80-85
 Sani-Adjustable Shelving..... 86-87
 Cooler & Backroom Shelving..... 88-89
 Correctional Shelving 90
 Dunnage Racks Economy 91
 Dunnage Racks Economy 91
 Dunnage Racks Gusset Leg..... 92
 Dunnage Racks Plastic 92
 Wall Shelves, Aluminum Knock Down..... 92

Food Handling

93-100

Lug Carts 94
 Bulk Movers..... 95
 Platter Carts..... 96
 Universal Carts 97
 Crisping Rack 97
 Insulated Displays 98-99
 Icing Cart 99
 Film Wrappers 100

Merchandising

101-106

Knock Down Bread Rack..... 102
 Sample Demo Table..... 102
 Bagel & Bread Display Racks..... 103
 Bagel, Bread, and Bun Baskets..... 103
 Mobile Slant Merchandiser 104
 Plant & General Merchandiser 104
 Merchandise Display Stand..... 105
 Mobile Display Merchandiser 106

TABLE OF CONTENTS (cont'd)

Material Handling & Distribution 107-120

U-Boats®	108-110
U-Boat® Accessories	111
Folding U-Boat®	111
U-Boat®, Slanted Shelves.....	112
Platform Trucks, Plastic Deck.....	113
Utility, Stocking & Marking Carts	114-118
Wet Produce Carts	118
Jumbo Bulk Mover.....	119
Garment Rack	119
Cart Corral	119
Hand Trucks	120



Roll Cages & Distribution Carts 121-124

Folding Roll Cages	122
E-commerce Picking Cart.....	122
Distribution Carts	123
Security Cages	124
Shelf Cart.....	124



Smallwares 125-132

Platter and Trays	126
Bagel Boards	126
Baskets, Bagel and Bread	127
Bagel Scoop	127
Pizza Dough Boxes	127
Display Trays, Stainless Steel	128
Lugs.....	127
Stack & Nest Containers	129
Merchandise Stands.....	130
Shopping Baskets.....	131
Wire Dividers	131
Rack Covers	132
Cutting Boards.....	132





TABLE OF CONTENTS (cont'd)

Lockers & Receiving Desks 133-140

Locker, Steel..... 134-136
 Locker Accessories 137
 Receiving Desks, Steel..... 138-139
 Receiving Desks, Stainless Steel..... 140

Parts, Wheels & Casters 141-146

Film Wrappers, Parts..... 142
 Heater Proofer, Parts..... 143
 Wheel and Caster Ordering Information..... 144
 Plate Casters & Wheels..... 145
 Stem Casters & Wheels 146
 Oven Casters & Wheels 146
 Hand Truck Wheels..... 146



Ordering Info 147-150

Terms & Conditions of Sale..... 148
 Warranty Statement..... 149
 A Place for your Notes..... 150

Index 151-177

Index by Model Number 151-177



STAINLESS STEEL FABRICATION



- Custom Solutions
- Compartment Sinks
- Specialty Sinks
- Compartment Sink Modifications
- Hand Sinks
- Mop & Drop-In Sinks
- Dish Tables
- Dish Table Modifications
- Wall Shelves
- Pot Racks
- Wall Mounted Cabinets
- Faucets & Parts
- Work Tables
- Enclosed Base Tables
- Table Modifications
- Work Station Shelves
- Beverage Counters
- Dish Cabinets
- Fill Tables
- Equipment Stands
- Wall Shelves
- Port Racks
- Wall Mounted Cabinets

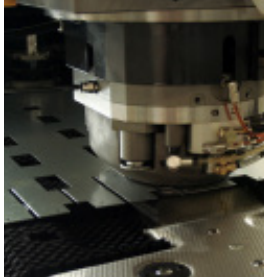

WinFab™ Stainless Steel Fabrication

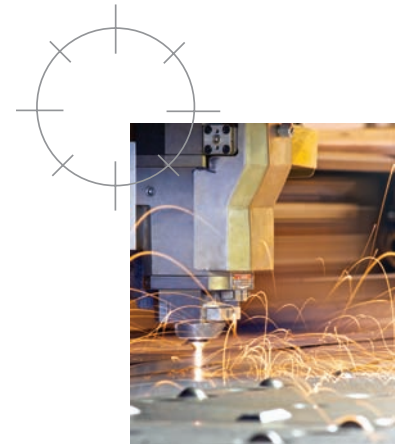

Building on our reputation for meeting our customers requirements, Winholt developed WinFab™, a resourceful and practical approach to modifying standard sinks, tables, dish tables or cabinets. Select from a host of “add on” options that increase productivity and manage costs. For example, by adding a large drainboard, a deeper sink, various sized backsplashes or different table finishes you can enhance your workspace easily and efficiently. With WinFab™, you choose the modification for your stainless steel sink or table. WinHolt builds it for you.

Consider these possibilities:

- Save Space - Add a glass rack above your dish table
- Expand Your Work Area - Change the length of your counter or drainboard
- Build-In Greater Convenience - Choose a single or double overhead shelf to keep frequently used items within reach
- Increase Storage - Add a shelf under your dish table or countertop

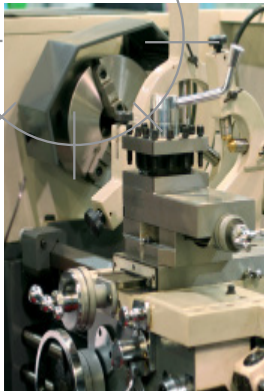

Getting the right product fabricated has never been easier. Begin with a standard model and select from a wide assortment of add-on accessories to tailor the equipment to fit your needs.

WinFab's fabrication solutions maximize your work space with quality products that offer the versatility of custom stainless steel fabrication at budget-friendly prices.

Our experienced sales, engineering, and design teams are ready to help you design a new work space or transform an existing space. Call now and turn your ideas into reality in no time at all.

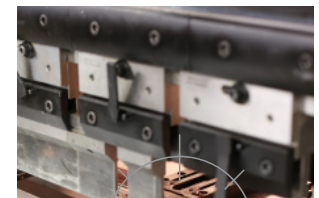

Design your work space and become more productive with Winholt's WinFab™ Stainless Steel Fabrication Program.



Powder Coating

Powder coating enhances the look of your product giving it an attractive appearance. Powder coating offers a durable coating on the toughest equipment. Powder coating can adhere to steel, aluminum, and stainless steel. Color coat your equipment by floor, department, meal times, or HACCP controls. Powder coating is environmentally friendly. Hand painted in the United States by our experienced team. Whatever your color, we can accommodate your needs.



Laminates

Laminates enhance the look of your product, giving it an attractive appearance. Match the decor or theme of your stadium, cafeteria, restaurant, or hospital. Hide the aluminum or stainless steel institutional look with laminates.



Vinyl Graphics

Differentiate your business and services from the competition with vinyl graphics. Feature products, services and brand to maximum visibility for advertising. Hide the aluminum or stainless steel institutional look with vinyl graphics. Use in combination with powder coating and laminates for a truly unique design. Vinyl graphics are water proof and conform to irregular sizes and surfaces. Available in 1, 2, 3, and 4 color process.



Designer Stainless

Give your stainless project a truly unique design with designer stainless sheets. Endless selection of designs, call for details. Minimum quantities required.



Granite, Marble, Corian®, Wood Tops

Winholt can enhance the look of front end operations or merchandising with granite, marble, corian and wood tops.

Many options available. Call your sales representative to schedule a consultation.



Anatomy of a Sink

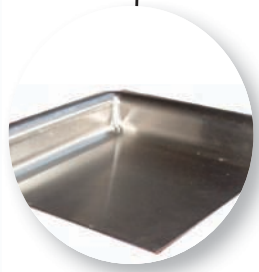
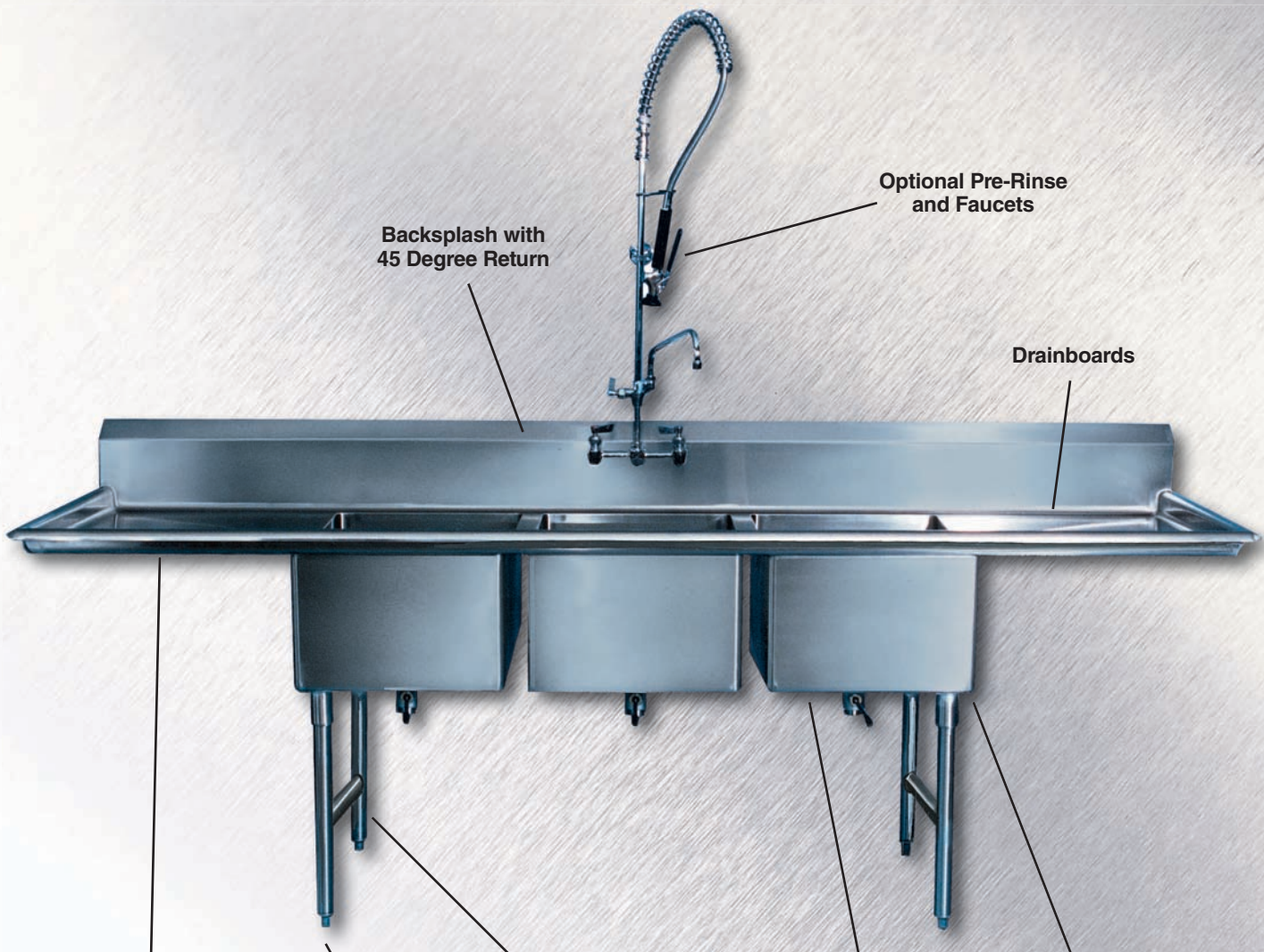

Rolled Rim Edges



Stainless Clad Bullet Feet



Legs Mounted Under Sink Bowls for Added Weight Capacity



Fabricated Bowls



Coved Corner Sink Bowls

<p>SS SERIES Standard</p>	<p>16 Gauge, 304 series stainless steel bowls and legs with stainless steel clad bullet feet. Fabricated bowls are 12" deep water level.</p>
<p>DC SERIES Design Consultant</p>	<p>14 Gauge, 304 series stainless steel bowls and legs with stainless steel clad bullet feet. Fabricated bowls are 14" deep water level.</p>

Stainless Sinks - 1 Compartment without Drainboard

- All welded construction.
- Complies with all sanitary standards: 16 GA or 14 GA 304 series stainless steel.
- 12" or 14" deep fabricated bowls with covered corners.
- Cross bracing for heavy duty support and stability.
- Equipped with stainless steel gussets, stainless steel legs and stainless steel clad adjustable feet for leveling.
- 9" backsplash with 45 degree return.

BOWL SIZE IN (MM)	LxW IN (MM)	SS SERIES 16 GAUGE 12" WATER LEVEL	WGT. LBS (KG)	DC SERIES 14 GAUGE 14" WATER LEVEL	WGT. LBS (KG)
16"x18" (406x457)	21"x23½" (533x597)	WS1T1618	45 (20)	WS1T1618/14DP/14GA	50 (23)
18"x18" (457x457)	23"x23½" (584x597)	WS1T1818	45 (20)	WS1T1818/14DP/14GA	50 (23)
16"x20" (406x508)	21"x25½" (533x648)	WS1T1620	43 (20)	WS1T1620/14DP/14GA	55 (24)
20"x20" (508x508)	25"x25½" (635x648)	WS1T2020	55 (25)	WS1T2020/14DP/14GA	60 (27)
18"x24" (457x610)	23"x29½" (584x749)	WS1T1824	53 (24)	WS1T1824/14DP/14GA	59 (27)
24"x24" (610x610)	29"x29½" (737x749)	WS1T2424	62 (28)	WS1T2424/14DP/14GA	68 (31)
20"x28" (508x711)	25"x33½" (635x851)	WS1T2028	65 (30)	WS1T2028/14DP/14GA	72 (33)

OPTION: WB18 18" WALL BRACKETS

Freight Class: 200



Stainless Sinks - 1 Compartment with 2 Drainboards

BOWL SIZE IN (MM)	LxW IN (MM)	DRBD SIZE IN (MM)	SS SERIES 16 GAUGE 12" WATER LEVEL	WGT. LBS (KG)	DC SERIES 14 GAUGE 14" WATER LEVEL	WGT. LBS (KG)
16"x18" (406x457)	52"x23½" (1321x597)	18" (457)	WS1T16182D18	62 (28)	W1T16182D18/14DP/14GA	68 (31)
	64"x23½" (1626x597)	24" (610)	WS1T16182D24	69 (31)	WS1T16182D24/14DP/14GA	77 (35)
18"x18" (457x457)	54"x23½" (1372x597)	18" (457)	WS1T18182D18	71 (32)	W1T18182D18/14DP/14GA	76 (35)
	66"x23½" (1676x597)	24" (610)	WS1T18182D24	80 (36)	WS1T18182D24/14DP/14GA	87 (29)
16"x20" (406x508)	52"x25½" (1321x648)	18" (457)	WS1T16202D18	66 (30)	WS1T16202D18/14DP/14GA	70 (32)
	64"x25½" (1626x648)	24" (610)	WS1T16202D24	74 (34)	WS1T16202D24/14DP/14GA	80 (36)
20"x20" (508x508)	40"x25½" (1016x648)	18" (457)	WS1T20202D18	85 (39)	WS1T20202D18/14DP/14GA	90 (41)
	44"x25½" (1118x648)	24" (610)	WS1T20202D24	95 (43)	WS1T20202D24/14DP/14GA	101 (46)
18"x24" (457x610)	54"x29½" (978x749)	18" (457)	WS1T18242D18	75 (34)	WS1T18242D18/14DP/14GA	80 (32)
	66"x29½" (1130x749)	24" (610)	WS1T18242D24	83 (38)	WS1T18242D24/14DP/14GA	91 (34)
24"x24" (610x610)	60"x29½" (1524x749)	18" (457)	WS1T24242D18	92 (42)	WS1T24242D18/14DP/14GA	95 (43)
	72"x29½" (1829x749)	24" (610)	WS1T24242D24	112 (51)	WS1T24242D24/14DP/14GA	103 (47)
20"x28" (508x711)	40"x33½" (1016x851)	18" (457)	WS1T20282D18	102 (46)	WS1T20282D18/14DP/14GA	115 (52)
	44"x33½" (1118x851)	24" (610)	WS1T2028/2D24	125 (57)	WS1T20282D24/14DP/14GA	126 (57)

OPTION: WB18 18" WALL BRACKETS

Freight Class: 200



Faucets and parts sold separately. See pages 24 & 25.



**Stainless Sinks
1 Compartment
with 1 Drainboard**



Faucets and parts
sold separately.
See pages 24 & 25.

**Customize it with
WinFab**

- Stainless Sink Single Compartment with Left Hand Drainboard
- 14" Swing Faucet Splash Mount
- Rotary Lever Waste Valve with Flat Strainer
- Flange Feet



BOWL SIZE IN (MM)	LxW IN (MM)	DRBD SIZE IN (MM)	DRBD LEFT RIGHT	SS SERIES 16 GAUGE 12" WATER LEVEL	WGT LBS (KG)	DC SERIES 14 GAUGE 14" WATER LEVEL	WGT LBS (KG)
16"x18" (406x457)	36½x23½ (927x597)	18" (457)	LEFT	WS1T1618LD18	53 (24)	WS1T1618LD18/14DP/14GA	56 (25)
			RIGHT	WS1T1618RD18		WS1T1618RD18/14DP/14GA	
	42½x23½ (1080x597)	24" (610)	LEFT	WS1T1618LD24	57 (26)	WS1T1618LD24/14DP/14GA	60 (27)
			RIGHT	WS1T1618RD24		WS1T1618RD24/14DP/14GA	
18"x18" (457x457)	38½x23½ (978x597)	18" (457)	LEFT	WS1T1818LD18	55 (25)	WS1T1818LD18/14DP/14GA	59 (27)
			RIGHT	WS1T1818RD18		WS1T1818RD18/14DP/14GA	
	44½x23½ (1130x597)	24" (610)	LEFT	WS1T1818LD24	58 (26)	WS1T1818LD24/14DP/14GA	63 (29)
			RIGHT	WS1T1818RD24		WS1T1818RD24/14DP/14GA	
16"x20" (406x508)	36½x25½ (927x648)	18" (457)	LEFT	WS1T1620LD18	54 (25)	WS1T1620LD18/14DP/14GA	58 (26)
			RIGHT	WS1T1620RD18		WS1T1620RD18/14DP/14GA	
	42½x25½ (1080x648)	24" (610)	LEFT	WS1T1620LD24	57 (26)	WS1T1620LD24/14DP/14GA	62 (28)
			RIGHT	WS1T1620RD24		WS1T1620RD24/14DP/14GA	
20"x20" (508x508)	40½x25½ (1029x648)	18" (457)	LEFT	WS1T2020LD18	70 (32)	WS1T2020LD18/14DP/14GA	77 (35)
			RIGHT	WS1T2020RD18		WS1T2020RD18/14DP/14GA	
	46½x25½ (1181x648)	24" (610)	LEFT	WS1T2020LD24	74 (34)	WS1T2020LD24/14DP/14GA	83 (38)
			RIGHT	WS1T2020RD24		WS1T2020RD24/14DP/14GA	
18"x24" (457x610)	38½x29½ (978x749)	18" (457)	LEFT	WS1T1824LD18	64 (29)	WS1T1824LD18/14DP/14GA	70 (32)
			RIGHT	WS1T1824RD18		WS1T1824RD18/14DP/14GA	
	44½x29½ (1130x749)	24" (610)	LEFT	WS1T1824LD24	68 (31)	WS1T1824LD24/14DP/14GA	75 (34)
			RIGHT	WS1T1824RD24		WS1T1824RD24/14DP/14GA	
24"x24" (610x610)	50½x29½ (1283x749)	24" (610)	LEFT	WS1TS2424LD24	77 (35)	WS1TS2424LD24/14DP/14GA	85 (39)
			RIGHT	WS1TS2424RD24		WS1TS2424RD24/14DP/14GA	
20"x28" (508x711)	40½x33½ (1029x851)	18" (457)	LEFT	WS1T2028LD18	87 (39)	WS1T2028LD18/14DP/14GA	97 (44)
			RIGHT	WS1T2028RD18		WS1T2028RD18/14DP/14GA	
	46½x33½ (1181x851)	24" (610)	LEFT	WS1T2028LD24	88 (40)	WS1T2028LD24/14DP/14GA	101 (46)
			RIGHT	WS1T2028RD24		WS1T2028RD24/14DP/14GA	

OPTION: WB18 18" WALL BRACKETS
Freight Class: 200



Stainless Sinks - 2 Compartment without Drainboard



BOWL SIZE IN (MM)	LxW IN (MM)	SS SERIES 16 GAUGE 12" WATER LEVEL	WGT. LBS (KG)	DC SERIES 14 GAUGE 14" WATER LEVEL	WGT. LBS (KG)
16"x18" (406x457)	39"x23½" (991x597)	WS2T1618	74 (34)	WS2T1618/14DP/14GA	79 (36)
18"x18" (457x457)	43"x23½" (1092x597)	WS2T1818	78 (35)	WS2T1818/14DP/14GA	85 (39)
16"x20" (406x508)	39"x25½" (991x648)	WS2T1620	76 (35)	WS2T1620/14DP/14GA	83 (38)
20"x20" (508x508)	47"x25½" (1194x648)	WS2T2020	96 (44)	WS2T2020/14DP/14GA	110 (50)
18"x24" (457x610)	43"x29½" (10924x749)	WS2T1824	92 (44)	WS2T1824/14DP/14GA	103 (47)
24"x24" (610x610)	55"x29½" (1397x749)	WS2T2424	109 (50)	WS2T2424/14DP/14GA	124 (56)
20"x28" (508x711)	47"x33½" (1194x851)	WS2T2028	115 (52)	WS2T2028/14DP/14GA	134 (61)

OPTION: WB18 18" WALL BRACKETS
Freight Class: 200



Stainless Sinks - 2 Compartment with 2 Drainboards

BOWL SIZE IN (MM)	LxW IN (MM)	DRBD SIZE IN (MM)	SS SERIES 16 GAUGE 12" WATER LEVEL	WGT. LBS (KG)	DC SERIES 14 GAUGE 14" WATER LEVEL	WGT. LBS (KG)
16"x18" (406x457)	70"x23½" (1778x597)	18" (457)	WS2T16182D18	83 (38)	WS2T16182D18/14DP/14GA	90 (41)
	82"x23½" (2083x597)	24" (610)	WS2T16182D24	86 (39)	WS2T16182D24/14DP/14GA	95 (43)
18"x18" (457x457)	74"x23½" (1880x597)	18" (457)	WS2T18182D18	96 (44)	WS2T18182D18/14DP/14GA	106 (48)
	86"x23½" (2184x597)	24" (610)	WS2T18182D24	103 (47)	WS2T18182D24/14DP/14GA	115 (52)
16"x20" (406x508)	70"x25½" (1778x648)	18" (457)	WS2T16202D18	94 (34)	WS2T16202D18/14DP/14GA	103 (47)
	82"x25½" (2082x648)	24" (610)	WS2T16202D24	101 (46)	WS2T16202D24/14DP/14GA	112 (51)
20"x20" (508x508)	78"x25½" (1981x648)	18" (457)	WS2T20202D18	135 (61)	WS2T20202D18/14DP/14GA	150 (68)
	90"x25½" (2286x648)	24" (610)	WS2T20202D24	150 (68)	WS2T20202D24/14DP/14GA	159 (72)
18"x24" (457x610)	74"x29½" (1880x749)	18" (457)	WS2T18242D18	113 (51)	WS2T18242D18/14DP/14GA	130 (59)
	86"x29½" (2184x749)	24" (610)	WS2T18242D24	122 (55)	WS2T18242D24/14DP/14GA	139 (63)
24"x24" (610x610)	86"x29½" (2184x597)	18" (457)	WS2T24242D18	128 (58)	WS2T24242D18/14DP/14GA	155 (70)
	98"x29½" (2489x749)	24" (610)	WS2T24242D24	139 (63)	WS2T24242D24/14DP/14GA	160 (73)
20"x28" (508x711)	82"x35½" (2083x902)	18" (457)	WS2T20282D18	159 (72)	WS2T20282D18/14DP/14GA	175 (80)
	90"x35½" (2286x902)	24" (610)	WS2T20282D24	170 (77)	WS2T20282D24/14DP/14GA	185 (84)

OPTION: WB18 18" WALL BRACKETS
Freight Class: 200



Faucets and parts
sold separately.
See pages 24 & 25.

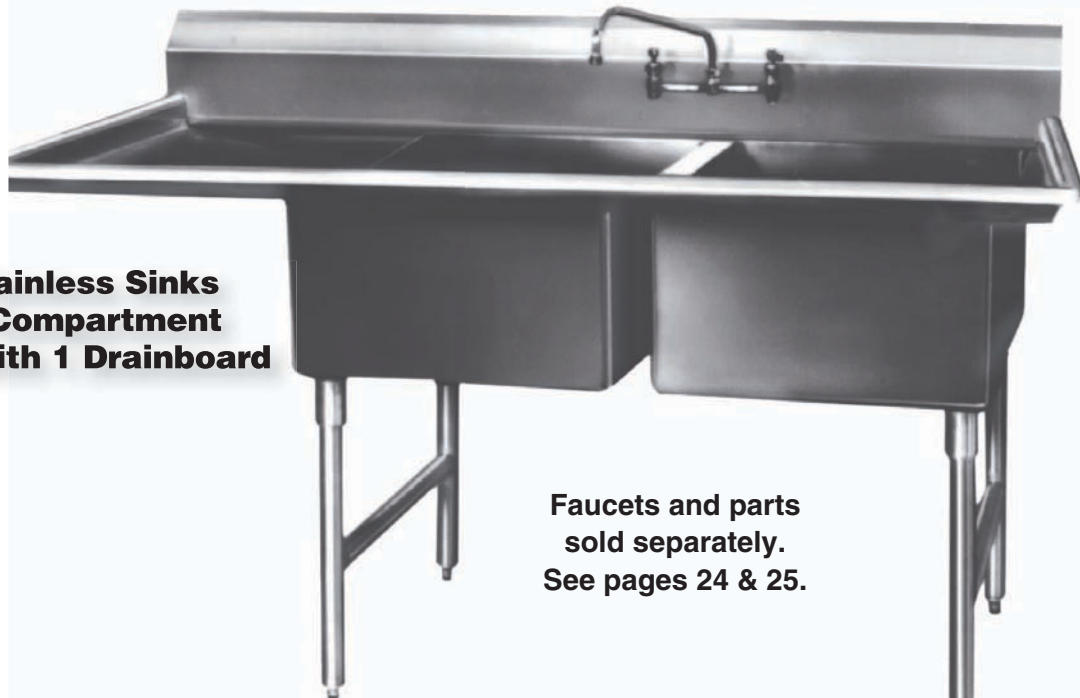

**Stainless Sinks
2 Compartment
with 1 Drainboard**

Faucets and parts
sold separately.
See pages 24 & 25.

BOWL SIZE IN (MM)	LxW IN (MM)	DRBD SIZE IN (MM)	DRBD LEFT RIGHT	SS SERIES 16 GAUGE 12" WATER LEVEL	WGT LBS (KG)	DC SERIES 14 GAUGE 14" WATER LEVEL	WGT LBS (KG)
16"x18" (406x457)	54½"x23½" (1384x597)	18" (457)	LEFT	WS2T1618LD18	83 (38)	WS2T1618LD18/14DP/14GA	90 (41)
			RIGHT	WS2T1618RD18		WS2T1618RD18/14DP/14GA	
	60½"x23½" (1537x597)	24" (610)	LEFT	WS2T1618LD24	86 (39)	WS2T1618LD24/14DP/14GA	95 (43)
			RIGHT	WS2T1618RD24		WS2T1618RD24/14DP/14GA	
18"x18" (467x457)	58½"x23½" (1486x597)	18" (457)	LEFT	WS2T1818LD18	87 (40)	WS2T1818LD18/14DP/14GA	95 (43)
			RIGHT	WS2T1818RD18		WS2T1818RD18/14DP/14GA	
	64½"x23½" (1638x597)	24" (610)	LEFT	WS2T1818LD24	90 (41)	WS2T1818LD24/14DP/14GA	100 (45)
			RIGHT	WS2T1818RD24		WS2T1818RD24/14DP/14GA	
16"x20" (406x508)	54½"x25½" (1384x648)	18" (457)	LEFT	WS2T1620LD18	85 (39)	WS2T1620LD18/14DP/14GA	93 (42)
			RIGHT	WS2T1620RD18		WS2T1620RD18/14DP/14GA	
	60½"x25½" (1537x648)	24" (610)	LEFT	WS2T1620LD24	88 (40)	WS2T1620LD24/14DP/14GA	98 (45)
			RIGHT	WS2T1620RD24		WS2T1620RD24/14DP/14GA	
20"x20" (508x508)	62½"x25½" (1588x648)	18" (457)	LEFT	WS2T2020LD18	117 (53)	WS2T2020LD18/14DP/14GA	133 (60)
			RIGHT	WS2T2020RD18		WS2T2020RD18/14DP/14GA	
	68½"x25½" (1740x648)	24" (610)	LEFT	WS2T2020LD24	122 (55)	WS2T2020LD24/14DP/14GA	142 (65)
			RIGHT	WS2T2020RD24		WS2T2020RD24/14DP/14GA	
18"x24" (457x610)	58½"x29½" (1486x749)	18" (457)	LEFT	WS2T1824LD18	107 (49)	WS2T1824LD18/14DP/14GA	120 (55)
			RIGHT	WS2T1824RD18		WS2T1824RD18/14DP/14GA	
	64½"x29½" (1638x749)	24" (610)	LEFT	WS2T1824LD24	111 (50)	WS2T1824LD24/14DP/14GA	126 (57)
			RIGHT	WS2T1824RD24		WS2T1824RD24/14DP/14GA	
24"x24" (610x610)	76½"x29½" (1943x749)	24" (610)	LEFT	WS2TS2424LD24	127 (58)	WS2TS2424LD24/14DP/14GA	146 (66)
			RIGHT	WS2TS2424RD24		WS2TS2424RD24/14DP/14GA	
20"x28" (508x711)	62½"x33½" (1588x851)	18" (457)	LEFT	WS2T2028LD18	175 (80)	WS2T2028LD18/14DP/14GA	190 (86)
			RIGHT	WS2T2028RD18		WS2T2028RD18/14DP/14GA	
	68½"x33½" (1740x851)	24" (610)	LEFT	WS2T2028LD24	185 (84)	WS2T2028LD24/14DP/14GA	199 (90)
			RIGHT	WS2T2028RD24		WS2T2028RD24/14DP/14GA	

OPTION: WB18 18" WALL BRACKETS
Freight Class: 200



Stainless Sinks - 3 Compartment without Drainboard

BOWL SIZE IN (MM)	LxW IN (MM)	SS SERIES 16 GAUGE 12" WATER LEVEL	WGT. LBS (KG)	DC SERIES 14 GAUGE 14" WATER LEVEL	WGT. LBS (KG)
16"x18" (406x457)	57"x23½" (1448x597)	WS3T1618	40 (18)	WS3T1618/14DP/14GA	44 (20)
18"x18" (457x457)	63"x23½" (1600x597)	WS3T1818	109 (50)	WS3T1818/14DP/14GA	124 (56)
16"x20" (406x508)	57"x25½" (1448x648)	WS3T1620	107 (49)	WS3T1620/14DP/14GA	119 (54)
20"x20" (508x508)	69"x25½" (1753x648)	WS3T2020	142 (65)	WS3T2020/14DP/14GA	165 (75)
18"x24" (457x610)	63"x29½" (1600x749)	WS3T1824	131 (60)	WS3T1824/14DP/14GA	150 (68)
24"x24" (610x610)	81"x29½" (2057x749)	WS3T2424	157 (71)	WS3T2424/14DP/14GA	182 (83)
20"x28" (508x711)	69"x33½" (1753x851)	WS3T2028	170 (77)	WS3T2028/14DP/14GA	200 (91)

OPTION: **WB18** 18" WALL BRACKETS
Freight Class: 200



Stainless Sinks - 3 Compartment with 2 Drainboards

BOWL SIZE IN (MM)	LxW IN (MM)	DRBD SIZE IN (MM)	SS SERIES 16 GAUGE 12" WATER LEVEL	WGT. LBS (KG)	DC SERIES 14 GAUGE 14" WATER LEVEL	WGT. LBS (KG)
16"x18" (406x457)	88"x23½" (2235x597)	18" (457)	WS3T16182D18	121 (55)	WS3T16182D18/14DP/14GA	139 (63)
	100"x23½" (2540x597)	24" (610)	WS3T16182D24	128 (58)	WS3T16182D24/14DP/14GA	147 (67)
18"x18" (457x457)	94"x23½" (2388x597)	18" (457)	WS3T18182D18	127 (58)	WS3T18182D18/14DP/14GA	146 (66)
	106"x23½" (2743x597)	24" (610)	WS3T18182D24	134 (61)	WS3T18182D24/14DP/14GA	155 (70)
16"x20" (406x508)	88"x25½" (2235x648)	18" (457)	WS3T16202D18	125 (57)	WS3T16202D18/14DP/14GA	142 (65)
	100"x25½" (2540x648)	24" (610)	WS3T16202D24	132 (60)	WS3T16202D24/14DP/14GA	151 (69)
20"x20" (508x508)	100"x25½" (2540x749)	18" (457)	WS3T20202D18	180 (82)	WS3T20202D18/14DP/14GA	204 (93)
	112"x25½" (2854x749)	24" (610)	WS3T20202D24	191 (87)	WS3T20202D24/14DP/14GA	220 (100)
18"x24" (457x610)	94"x29½" (2388x749)	18" (457)	WS3T18242D18	172 (78)	WS3T18242D18/14DP/14GA	196 (89)
	106"x29½" (2692x749)	24" (610)	WS3T18242D24	180 (82)	WS3T18242D24/14DP/14GA	207 (94)
24"x24" (610x610)	112"x29½" (2845x749)	18" (457)	WS3T24242D18	190 (86)	WS3T24242D18/14DP/14GA	229 (104)
	124"x29½" (3150x749)	24" (610)	WS3T24242D24	206 (94)	WS3T24242D24/14DP/14GA	239 (109)
20"x28" (508x711)	102"x33½" (2641x851)	18" (457)	WS3T20282D18	62 (28)	WS3T20282D18/14DP/14GA	219 (100)
	112"x33½" (2946x851)	24" (457)	WS3T20282D24	65 (30)	WS3T20282D24/14DP/14GA	229 (104)

OPTION: **WB18** 18" WALL BRACKETS
Freight Class: 200

Faucets and parts sold separately.
See pages 24 & 25.



**Stainless Sinks
3 Compartment
with 1 Drainboard**



Faucets and parts
sold separately.
See pages 24 & 25.

BOWL SIZE IN (MM)	LxW IN (MM)	DRBD SIZE IN (MM)	DRBD LEFT RIGHT	SS SERIES 16 GAUGE 12" WATER LEVEL	WGT LBS (KG)	DC SERIES 14 GAUGE 14" WATER LEVEL	WGT LBS (KG)
16"x18" (406x457)	72½x23½ (1842x597)	18" (457)	LEFT	WS3T1618LD18	112 (51)	WS3T1618LD18/14DP/14GA	127 (58)
			RIGHT	WS3T1618RD18		WS3T1618RD18/14DP/14GA	
	78½x23½ (1994x597)	24" (610)	LEFT	WS3T1618LD24	116 (53)	WS3T1618LD24/14DP/14GA	132 (60)
			RIGHT	WS3T1618RD24		WS3T1618RD24/14DP/14GA	
18"x18" (457x457)	78½x23½ (1994x597)	18" (457)	LEFT	WS3T1818LD18	118 (54)	WS3T1818LD18/14DP/14GA	135 (61)
			RIGHT	WS3T1818RD18		WS3T1818RD18/14DP/14GA	
	84½x23½ (2146x597)	24" (610)	LEFT	WS3T1818LD24	122 (55)	WS3T1818LD24/14DP/14GA	139 (63)
			RIGHT	WS3T1818RD24		WS3T1818RD24/14DP/14GA	
16"x20" (406x508)	72½x25½ (1842x648)	18" (457)	LEFT	WS3T1620LD18	115 (52)	WS3T1620LD18/14DP/14GA	120 (55)
			RIGHT	WS3T1620RD18		WS3T1620RD18/14DP/14GA	
	78½x25½ (1994x648)	24" (610)	LEFT	WS3T1620LD24	119 (54)	WS3T1620LD24/14DP/14GA	129 (59)
			RIGHT	WS3T1620RD24		WS3T1620RD24/14DP/14GA	
20"x20" (508x508)	84½x25½ (2146x648)	18" (457)	LEFT	WS3T2020LD18	165 (75)	WS3T2020LD18/14DP/14GA	185 (84)
			RIGHT	WS3T2020RD18		WS3T2020RD18/14DP/14GA	
	90½x25½ (2299x648)	24" (610)	LEFT	WS3T2020LD24	170 (77)	WS3T2020LD24/14DP/14GA	200 (91)
			RIGHT	WS3T2020RD24		WS3T2020RD24/14DP/14GA	
18"x24" (457x610)	78½x29½ (1994x749)	18" (457)	LEFT	WS3T1824LD18	141 (64)	WS3T1824LD18/14DP/14GA	163 (74)
			RIGHT	WS3T1824RD18		WS3T1824RD18/14DP/14GA	
	84½x29½ (2146x749)	24" (610)	LEFT	WS3T1824LD24	145 (66)	WS3T1824LD24/14DP/14GA	169 (77)
			RIGHT	WS3T1824RD24		WS3T1824RD24/14DP/14GA	
24"x24" (610x610)	102½x29½ (2604x749)	24" (610)	LEFT	WS3TS2424LD24	171 (78)	WS3TS2424LD24/14DP/14GA	201 (91)
RIGHT	WS3TS2424RD24	WS3TS2424RD24/14DP/14GA					
20"x28" (508x711)	84½x33½ (2146x851)	18" (457)	LEFT	WS3T2028LD18	185 (84)	WS3T2028LD18/14DP/14GA	215 (98)
			RIGHT	WS3T2028RD18		WS3T2028RD18/14DP/14GA	
	90½x33½ (2299x851)	24" (610)	LEFT	WS3T2028LD24	195 (88)	WS3T2028LD24/14DP/14GA	225 (102)
			RIGHT	WS3T2028RD24		WS3T2028RD24/14DP/14GA	

OPTION: WB18 18" WALL BRACKETS
Freight Class: 200





WS3T10142D18

Stainless Meat Platter Sink 3 Compartment

BOWL SIZE IN (MM)	LxW IN (MM)	DRBD SIZE IN (MM)	DRBD	SS SERIES 16 GAUGE 12" WATER LEVEL	WGT LBS (KG)
15"x32" (381x813)	69½"x37½" (1765x953)	18" (457)	LEFT	WS3T1532LD18	183 (83)
15"x32" (381x813)	69½"x37½" (1765x953)	18" (457)	RIGHT	WS3T1532RD18	183 (83)
15"x32" (381x813)	69½"x37½" (1765x953)	18" (457)	LEFT & RIGHT	WS3T15322D18	183 (83)

Faucets and parts sold separately. See pages 24 & 25.

Stainless Bakery & Deli Sink 3 Compartment

BOWL SIZE IN (MM)	LxW IN (MM)	DRBD SIZE IN (MM)	DRBD	SS SERIES 16 GAUGE 12" WATER LEVEL	WGT LBS (KG)
19"x28" (483x711)	66"x33" (1676x851)			WS3T1928	175 (79)
19"x28" (483x711)	82½"x33" (2096x851)	18" (457)	LEFT	WS3T1928LD18	189 (86)
19"x28" (483x711)	82½"x33" (2096x851)	18" (457)	RIGHT	WS3T1928RD18	189 (86)
19"x28" (483x711)	99"x33" (2515x851)	18" (457)	LEFT & RIGHT	WS3T19282D18	199 (90)

Includes perforated basket

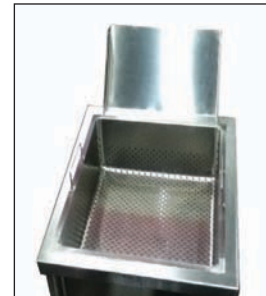

Stainless Convenience Sink 3 Compartment

BOWL SIZE IN (MM)	LxWxH IN (MM)	DRBD SIZE IN (MM)	DRBD	SS SERIES 16 GAUGE 12" WATER LEVEL	WGT LBS (KG)
10"x14" (254x356)	58½"x19½" (1473x495)	12" (305)	LEFT & RIGHT	WS3T10142D12	85 (38)
10"x14" (254x356)	70½"x19½" (1778x495)	18" (457)	LEFT & RIGHT	WS3T10142D18	120 (54)
14"x16" (356x406)	70½"x21½" (1778x546)	12" (305)	LEFT & RIGHT	WS3T14162D12	138 (62)

Removable chute



WS1T-SS2020-8/MLC

OPTION: WB18 18" WALL BRACKETS

Freight Class: 200



Silver Soak Sink with Chute

- Stainless steel 304 Series 14 GA Bowl
- 20"x20"x9" D Bowl
- Silver basket included
- 5" polyurethane casters, 2 with brakes

BOWL SIZE IN (MM)	LxWxH IN (MM)	MODEL	WGT LBS (KG)
20"x20"x9" (508x508x229)	24"x24"x20" (610x610x508)	WS1T-SS2020-8/MLC	50 (23)

Freight Class: 150



WinFab™ Sink Modifications

Top Modifications

WH-SCBL	Scrap Block Installed	each
WH-ASBH	Anti Siphon Vacuum Breaker Holes	each
WH-WFJ	Welded field joint (by other)	each
WH-DSCB	Installation of Disposal Cone with 6"x9" control bracket, faucet holes (Cone supplied by other)	each
WH-DSCB14	Installation of Disposal Cone with 14"x16" control bracket, faucet holes (Cone supplied by other)	each
WH-CNBRK	Control Bracket 6"x9"	each
WH-CNBRK14	Control Bracket 14"x16"	each
WH-DMFH	Deck mount holes per faucet	
WH-SPFH	Splash mount holes per faucet	
WH-WATRG	Waste trough with removable basket -2" deep	each
WH-COLLAR	Installation of collar with 6"x9" control bracket (collar supplied by other)	each
WH-COLLAR14	Installation of Collar with 14"x16" control bracket (collar supplied by other)	each

Underneath Modifications

WH-HFLEG	H-Frame support leg	each
WH-CBH	Cutting board holder	each
WH-CNBRK14	Control Bracket 14"x16"	each
WH-WHCG	Work height change	each
WS-SDDEAD	Soud Deadening	per lin. ft

Backsplash & Sidesplash Modifications

WH-SPCU	Splash cutout	each
WH-BS13	Backsplash up to 13"	per lin. ft
WH-BS18	Backsplash up to 18"	per lin. ft
WH-SSP	Sink sidesplash	each
WH-SSI	Integrated sidesplash	per lin. ft
WH-ABS	Add 5" backsplash	per lin. ft

Sink Bowl Modifications

WH-SSKRT	Sink skirt	per bowl
WH-OVFLCT	Punch for overflow holes only	each
WH-LVSB	Lever support bracket	each
WH-CT12XXXX	Custom bowl 12" deep	per sq. ft
WH-CT14XXXX	Custom bowl 14" deep	per sq. ft
WH-CT16XXXX	Custom bowl 16" deep	per sq. ft
WH-CTMOD	Modify bowl depth	each



Drainboard Modifications

WH-EXDB	Extra drainboard	per lin. ft
WH-DBCTN	Corner turn for drainboard	each
WH-USDB	Undershelf drainboard	per lin. ft

Additional Crating

WH-CRATE	Complete Crating	per sink
WH-EXPCRATE	Export Crating	per sink

WinFab™ Sink Accessories

Sink Cutting Boards for Sink Bowls

WSA-PSC1618	Poly top 16"x18" bowl	each
WSA-PSC1818	Poly top 18"x18" bowl	each
WSA-PSC1620	Poly top 16"x20" bowl	each
WSA-PSC2020	Poly top 20"x20" bowl	each
WSA-PSC1824	Poly top 18"x24" bowl	each
WSA-PSC2424	Poly top 24"x24" bowl	each
WSA-PSC1928	Poly top 19"x28" bowl	each
WSA-PSC2028	Poly top 20"x28" bowl	each
WSA-PSC1532	Poly top 15"x32" bowl	each

Stainless Steel Sink Cover for Sink Bowls

WSA-SSC1014	S/S Sink cover 10"x14" bowl	each
WSA-SSC1416	S/S Sink cover 14"x16" bowl	each
WSA-SSC1618	S/S Sink cover 16"x18" bowl	each
WSA-SSC1818	S/S Sink cover 18"x18" bowl	each
WSA-SSC1620	S/S Sink cover 16"x20" bowl	each
WSA-SSC2020	S/S Sink cover 20"x20" bowl	each
WSA-SSC1824	S/S Sink cover 18"x24" bowl	each
WSA-SSC2424	S/S Sink cover 24"x24" bowl	each
WSA-SSC1928	S/S Sink cover 19"x28" bowl	each
WSA-SSC2028	S/S Sink cover 20"x28" bowl	each
WSA-SSC1532	S/S Sink cover 15"x32" bowl	each

Leg Accessories

4497-3	Flanged stainless steel bullet foot Adj.	each
4471	Stainless steel clad foot Adj.	each
WS-SBSR	Solid rubber scrap block	each
WH-LWB	Leg to wall brace	each



Sink Modification Example Diagram

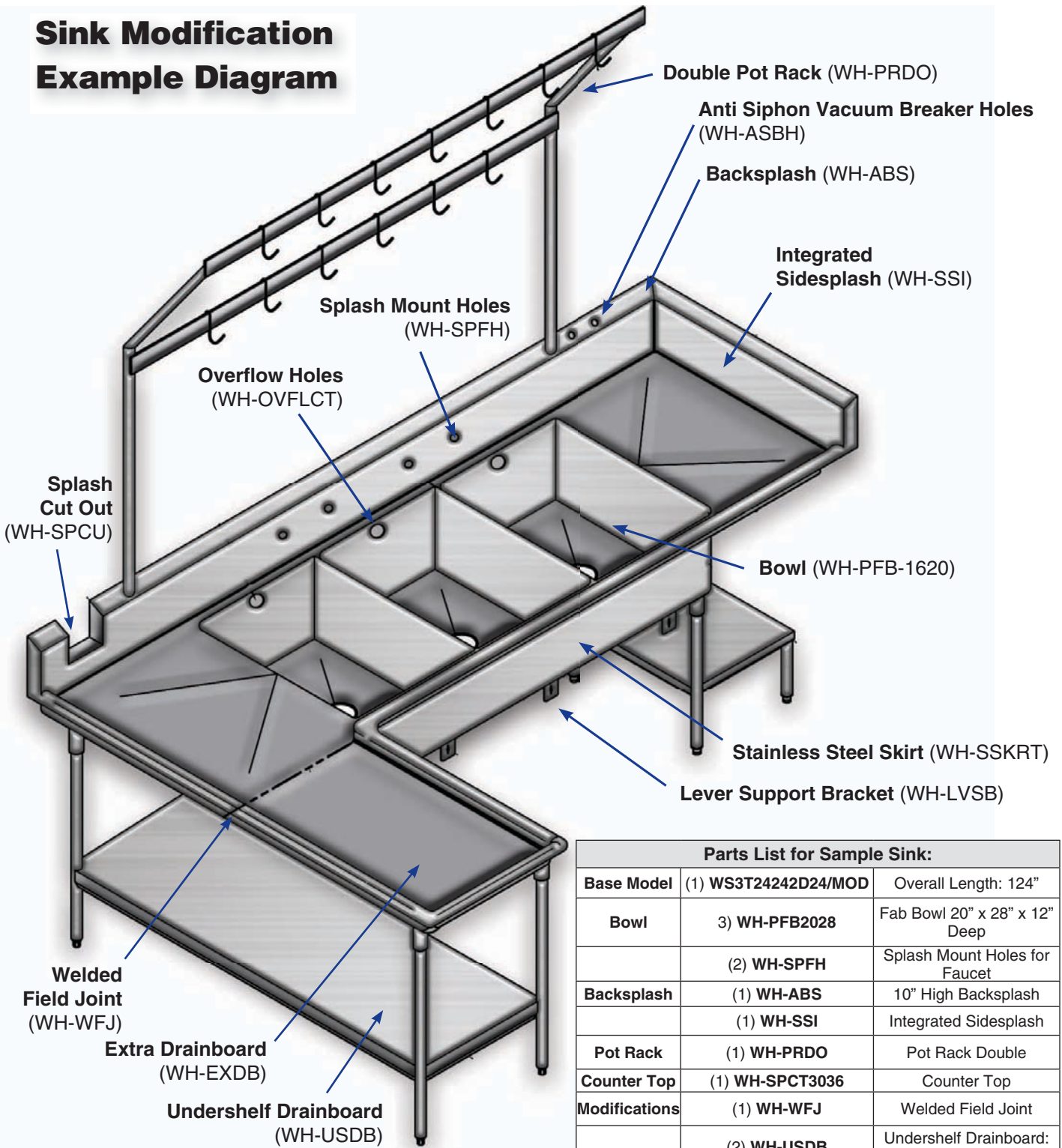

Parts List for Sample Sink:

Parts List for Sample Sink:		
Base Model	(1) WS3T24242D24/MOD	Overall Length: 124"
Bowl	3) WH-PFB2028	Fab Bowl 20" x 28" x 12" Deep
	(2) WH-SPFH	Splash Mount Holes for Faucet
Backsplash	(1) WH-ABS	10" High Backsplash
	(1) WH-SSI	Integrated Sidesplash
Pot Rack	(1) WH-PRDO	Pot Rack Double
Counter Top	(1) WH-SPCT3036	Counter Top
Modifications	(1) WH-WFJ	Welded Field Joint
	(2) WH-USDB	Undershelf Drainboard: 24"
	(1) WH-USDB	Undershelf Drainboard: 42"
	(1) WH-EXDB	Extra Drainboard
	(1) WH-ASBH	Anti Siphon Vacuum Breaker Holes
	(1) WH-SPCU	Splash Cut Out
	(3) WH-OVFLCT	Overflow Holes
	(1) WH-SSKRT	Stainless Steel Skirt
	(3) WH-LVSB	Lever Support Bracket
Accessories	(3) WS-RLWV-OF	Lever Operated Drain with Overflow





Economy Hand Sink

- High quality, 20 gauge stainless steel.
- Bowl is 5" deep
- Backsplash is 9-1/2".
- 4" Gooseneck faucet, 1-1/2" basket drain.

BOWL SIZE IN (MM)	LxW IN (MM)	MODEL	WGT LBS (KG)
10"x14"x5" (254x356x127)	17"x15" (387x438)	WSHS-1410-5-F	15 (7)



Hand Sink with Electric Eye Activated Faucet

- High quality 16 gauge stainless steel.
- 6" deep bowl
- Gooseneck faucet, basket drain and soap dispenser are all included.
- Standard with electric eye activated faucet.

BOWL SIZE IN (MM)	LxW IN (MM)	MODEL	WGT LBS (KG)
10"x14"x6" (254x356x152)	18"x15" (388x438)	WSHS-1410-EF	20 (0)



Hand Sink with Sidesplashes

- High quality, 20 gauge stainless steel.
- Bowl is 5" deep
- Backsplash is 9-1/2"
- 4" Gooseneck faucet, 1-1/2" basket drain.
- Welded sidesplashes

BOWL SIZE IN (MM)	LxW IN (MM)	MODEL	WGT LBS (KG)
10"x14"x5" (254x356x127)	17"x15" (387x438)	WSHS-1410-5-2SP	18 (8)



Pedestal Hand Sink 1 Pedal

- High quality 16 gauge stainless steel
- Foot Pedals for hands-free control lessens contamination
- Gooseneck faucet, Basket drain and soap dispenser are all included.
- 18" high backsplash.

BOWL SIZE IN (MM)	LxW IN (MM)	MODEL	WGT LBS (KG)
11"x10"x8" (279x254x203)	12"x11" (305x279)	WHPS1110	50 (23)



Hand Sink with Hand Valves

- High quality 16 gauge stainless steel
- 6" deep bowl
- Gooseneck faucet, basket drain and soap dispenser are all included.

BOWL SIZE IN (MM)	LxW IN (MM)	MODEL	WGT LBS (KG)
10"x14"x6" (254x356x152)	18"x15" (388x438)	WHWS1410HV	12 (6)



Pedestal Hand Sink - 2 Pedal

- High quality 16 gauge stainless steel
- Foot Pedals for hands-free control lessens contamination
- Gooseneck faucet, basket drain and soap dispenser are all included
- 7 3/4" backsplash



BOWL SIZE IN (MM)	LxW IN (MM)	MODEL	WGT LBS (KG)
16"x16"x10" (406x406x24)	18"x18" (387x438)	WHPS1616	50 (23)

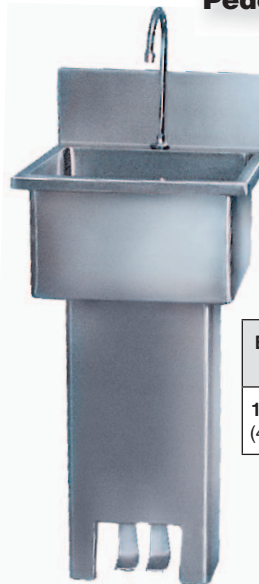

Hand Sink with Knee Valves

- High quality 16 gauge stainless steel
- 6" deep bowl
- Gooseneck faucet, basket drain and soap dispenser are all included

BOWL SIZE IN (MM)	LxW IN (MM)	MODEL	WGT LBS (KG)
10"x14"x6" (254x356x152)	18"x15" (388x438)	WWHS1410SP	45 (20)



Welded Side splashes for Hand Sinks

- Left Sidesplash: LSP
- Right Sidesplash: RSP
- Left & Right Sidesplash: 2SP



All Freight Class: 150



Mop Sinks

- High quality 16 gauge stainless steel
- 2" backsplash standard
- 3 1/2" basket drain

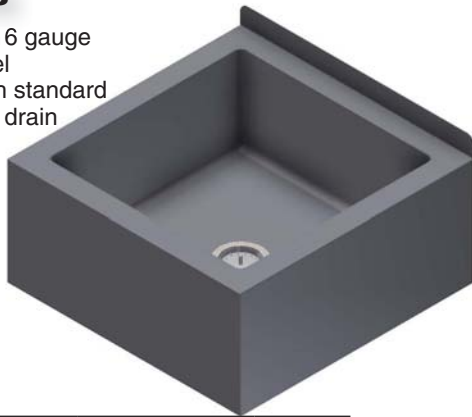

BOWL SIZE IN (MM) WxLxH	LxW IN (MM)	MODEL	WGT LBS (KG)
16"x20"x6" (406x508x152)	21"x25" (533x635)	MS1620-DP6-KT	26 (12)
16"x20"x12" (406x508x305)	20"x24" (508x610)	MS1620-DP12-KT	45 (20)
24"x24"x8" (610x610x203)	28"x28" (711x711)	MS-2424-DP8-KT	55 (25)

Mop Sink Flashings Options:

Specify options by adding suffix to model numbers

LFL	Left flashings	FL-CSSRL	Coved seam sealers for right, left or both flashings
RFL	Right flashing		
2FL	Left & Right flashing	FL-CSSB	Coved seam sealers back flashing
BFL	Back flashing		
FL-SFHOLE	Service faucet hole		

1, 2 & 3 Compartment No Drip Marine Edge Drop in Sinks

Compartment	BOWL SIZE IN (MM) WxLxH	LxW IN (MM)	MODEL	WGT LBS (KG)
1	10"x9.5"x10" (254x241x254)	14"x15.5" (356x394)	WS-DISME109.5	26 (12)
1	19"x10"x8" (279x229x381)	14"x16" (381x381)	WS-DISME1010DP8	28 (12)
1	11"x9"x15" (279x229x381)	15"x15" (381x381)	WS-DISME1109	28 (12)
1	11"x14"x6.5" (279x356x165)	15"x20" (381x508)	WS-DISME1114	32 (14)
1	21"x15.75"x12" (533x400x305)	25"x22" (635x559)	WS-DISME1621DP12	40 (18)
1	21"x15.75"x14" (533x400x356)	25"x22" (635x559)	WS-DISME1621DP14	42 (19)
2	10"x14"x10" (254x356x254)	25 1/2"x19" (648x483)	WS2T-DISME-1410-10DP	34 (15)
2	14"x16"x10" (356x406x254)	33 1/2"x21" (851x533)	WS2T-DISME-1614-10DP	39 (18)
2	14"x16"x12" (356x406x305)	33 1/2"x21" (851x533)	WS2T-DISME-1614-12DP	47 (21)
2	20"x16"x8" (508x406x203)	45 1/2"x21" (1158x533)	WS2T-DISME-1620-8DP	50 (23)
2	20"x16"x10" (508x406x254)	45 1/2"x21" (1158x533)	WS2T-DISME-1620-10DP	52 (23)
2	20"x16"x12" (508x406x305)	45 1/2"x21" (1158x533)	WS2T-DISME-1620-12DP	54 (24)
3	10"x14"x10" (254x356x254)	38 x 19 (965x483)	WS3T-DISME-1410-10DP	44 (20)
3	16"x14"x10" (406x356x254)	50 x 21 (1270x533)	WS3T-DISME-1416-10DP	48 (22)
3	16"x20"x12" (406x508x305)	56 x 25 (1422x635)	WS3T-DISME-2016-12DP	70 (32)

All Freight Class: 150

1 Compartment Self Rim Drop in Sink



- High quality 16 gauge stainless steel

BOWL SIZE IN (MM) WxLxDP	WxL IN (MM)	MODEL	WGT LBS (KG)
9"x9"x3" (229x229x76)	13"x16" (330x406)	WS-DIS-FE-99/3DP	16 (7)
10"x11"x6" (254x279x152)	13"x16" (330x406)	WS-DIS-FE-1110/6DP	16 (7)
10"x11"x10" (254x279x254)	13"x16" (330x406)	WS-DIS-FE-1110/10DP	18 (8)
10"x14"x6" (254x236x152)	13 x 19" (330x483)	WS-DIS-FE-1410/6DP	17 (8)
10"x14"x10" (254x356x254)	13 x 19" (330x483)	WS-DIS-FE-1410/10DP	19 (9)
14"x10"x6" (356x254x152)	17"x 15" (432x381)	WS-DIS-FE-1014/6DP	15 (7)
16"x14"x8" (406x356x203)	19"x 19" (483x483)	WS-DIS-FE-1416/8DP	25 (11)
20"x16"x8" (508x406x203)	32"x 21" (813x533)	WS-DIS-FE-1620/8DP	25 (11)
20"x16"x12" (508x406x305)	23"x 21" (584x533)	WS-DIS-FE-1620/12DP	30 (14)
28"x20"x12" (711x508x305)	31"x 25" (787x635)	WS-DIS-FE-2028/12DP	52 (23)

WS-DISME1109

- High quality 16 gauge stainless steel
- No drip edge standard.



WS2T-DISME-1614-10DP



Anatomy of a Dish Table



Sorting Shelf Single Table Mount



Scrap Basket



Optional Pre-Rinse and Splash Mount Faucet



Scrap Block Option

Backsplash with 45 Degree Return

Undershelf Option



Lever Drain Option



Stainless Clad Bullet Feet



"H" Frame Style Legs for Added Weight Support

Straight Soiled Dish Table
Left to Right (L)
Right to Left (R)

Standard Series - Standard

16 Gauge, 304 series stainless steel dish tables and legs with stainless steel clad bullet feet. Fabricated bowls are 12" deep water level.

Design Consultant Series

14 Gauge, 304 series stainless steel dish tables and legs with stainless steel clad bullet feet. Fabricated bowls are 14" deep water level.



SDT-14-S-72-R
 Right to Left

Faucets and parts
 sold separately.
 See pages 24 & 25.

SIZE IN (MM)	LxW IN (MM)	SS SERIES 16 GA	WGT. LBS (KG)	DC SERIES 14 GA	WGT. LBS (KG)
36" (914)	36"x30" (914x762)	SDT-16-S-36-L / R	75 (34)	SDT-14-S-36-L / R	85 (38)
48" (1219)	48"x30" (1219x762)	SDT-16-S-48-L / R	90 (41)	SDT-14-S-48-L / R	99 (45)
60" (1524)	60"x30" (1524x762)	SDT-16-S-60-L / R	100 (45)	SDT-14-S-60-L / R	110 (50)
72" (1829)	72"x30" (1829x762)	SDT-16-S-72-L / R	120 (55)	SDT-14-S-72-L / R	132 (60)
84" (2134)	84"x30" (2134x762)	SDT-16-S-84-L / R	130 (59)	SDT-14-S-84-L / R	143 (65)
96" (2438)	96"x30" (2438x762)	SDT-16-S-96-L / R	140 (64)	SDT-14-S-96-L / R	154 (70)

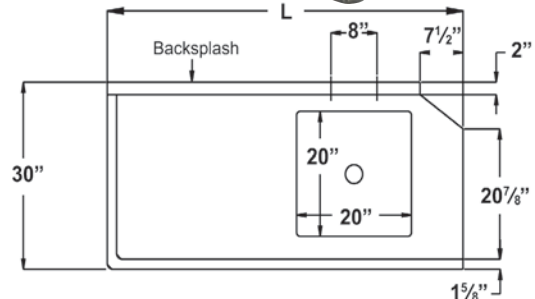

- 4 styles of tables available: straight, corner, island, and landed
- Constructed of 16 GA (SS) or 14 GA (DC) 304 series stainless
- Soiled table has a 20"x20"x8"D bowl to accept 3 1/2" drain basket
- Backsplash punched to accept faucets on 8" centers
- Backsplash is 9" high, with 2" 45 degree return to wall
- 37" to top of rolled rim
- Custom Sizes Available



CDT-16-S-60-L
 with undershelf
 Right to Left

Straight Clean Dish Table
Left to Right (L)
Right to Left (R)

SIZE IN (MM)	LxW IN (MM)	SS SERIES 16 GA	WGT. LBS (KG)	DC SERIES 14 GA	WGT. LBS (KG)
24" (610)	24"x30" (610x762)	CDT-16-S-24-L / R	25 (11)	CDT-14-S-24-L / R	29 (13)
36" (914)	36"x30" (914x762)	CDT-16-S-36-L / R	40 (18)	CDT-14-S-36-L / R	44 (20)
48" (1219)	48"x30" (1219x762)	CDT-16-S-48-L / R	50 (23)	CDT-14-S-48-L / R	55 (25)
60" (1524)	60"x30" (1524x762)	CDT-16-S-60-L / R	60 (27)	CDT-14-S-60-L / R	66 (30)
72" (1829)	72"x30" (1829x762)	CDT-16-S-72-L / R	80 (36)	CDT-14-S-72-L / R	88 (40)
84" (2134)	84"x30" (2134x762)	CDT-16-S-84-L / R	100 (45)	CDT-14-S-84-L / R	110 (50)
96" (2438)	96"x30" (2438x762)	CDT-16-S-96-L / R	110 (50)	CDT-14-S-96-L / R	121 (55)

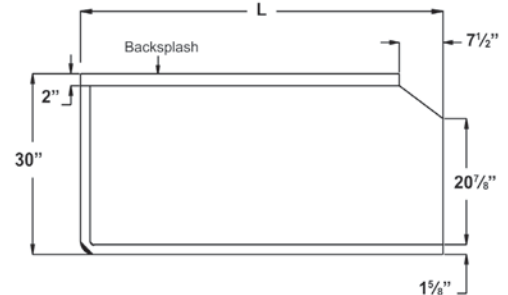

OPTION: WB18 18" Wall Brackets
 All Freight Class: 150



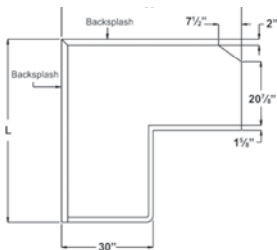
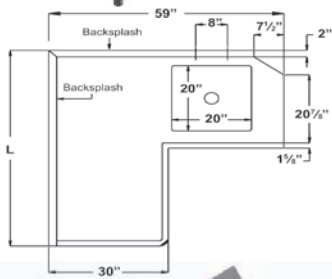

OPTION: WB18 18" Wall Brackets
All Freight Class: 150



Standard Series - Standard

16 Gauge, 304 series stainless steel dish tables and legs with stainless steel clad bullet feet. Fabricated bowls are 12" deep water level.

Design Consultant Series

14 Gauge, 304 series stainless steel dish tables and legs with stainless steel clad bullet feet. Fabricated bowls are 14" deep water level.

Corner Soiled Dish Table

Left to Right (L)

Right to Left (R)

SIZE IN (MM)	LxW IN (MM)	SS SERIES 16 GA	WGT. LBS (KG)	DC SERIES 14 GA	WGT. LBS (KG)
48" (1219)	48"x30" (1219x762)	SDT-16-C-48-L / R	90 (41)	SDT-14-C-48-L / R	99 (45)
60" (1524)	60"x30" (1524x762)	SDT-16-C-60-L / R	100 (45)	SDT-14-C-60-L / R	110 (50)
72" (1829)	72"x30" (1829x762)	SDT-16-C-72-L / R	120 (55)	SDT-14-C-72-L / R	132 (60)
84" (2134)	84"x30" (2134x762)	SDT-16-C-84-L / R	130 (59)	SDT-14-C-84-L / R	143 (65)
96" (2438)	96"x30" (2438x762)	SDT-16-C-96-L / R	140 (64)	SDT-14-C-96-L / R	154 (70)
120" (3048)	120"x30" (3048x762)	SDT-16-C-120-L / R	160 (73)	SDT-14-C-120-L / R	176 (80)
144" (3658)	144"x30" (3658x762)	SDT-16-C-144-L / R	176 (79)	SDT-14-C-144-L / R	211 (95)

Faucets and parts sold separately.
See pages 24 & 25.

Corner Clean Dish Table

Left to Right (L)

Right to Left (R)

SIZE IN (MM)	LxW IN (MM)	SS SERIES 16 GA	WGT. LBS (KG)	DC SERIES 14 GA	WGT. LBS (KG)
48" (1219)	48"x30" (1219x762)	CDT-16-C-48-L / R	50 (23)	CDT-14-C-48-L / R	55 (25)
60" (1524)	60"x30" (1524x762)	CDT-16-C-60-L / R	60 (27)	CDT-14-C-60-L / R	66 (30)
72" (1829)	72"x30" (1829x762)	CDT-16-C-72-L / R	80 (36)	CDT-14-C-72-L / R	88 (40)
84" (2134)	84"x30" (2134x762)	CDT-16-C-84-L / R	100 (45)	CDT-14-C-84-L / R	110 (50)
96" (2438)	96"x30" (2438x762)	CDT-16-C-96-L / R	110 (50)	CDT-14-C-96-L / R	121 (55)
120" (3048)	120"x30" (3048x762)	CDT-16-C-120-L / R	140 (63)	CDT-14-C-120-L / R	150 (53)
144" (3658)	144"x30" (3658x762)	CDT-16-C-144-L / R	168 (76)	CDT-14-C-144-L / R	178 (80)

- 4 styles of tables available: straight, corner, island,, and landed
- Constructed of 16 GA (SS) or 14 GA (DC) 304 series stainless
- Soiled table has a 20"x20"x8"D bowl to accept 3 1/2" drain basket
- Backsplash punched to accept faucets on 8" centers
- Backsplash is 9" high, with 2" 45 degree return to wall
- 37" to top of rolled rim
- **Custom Sizes Available**

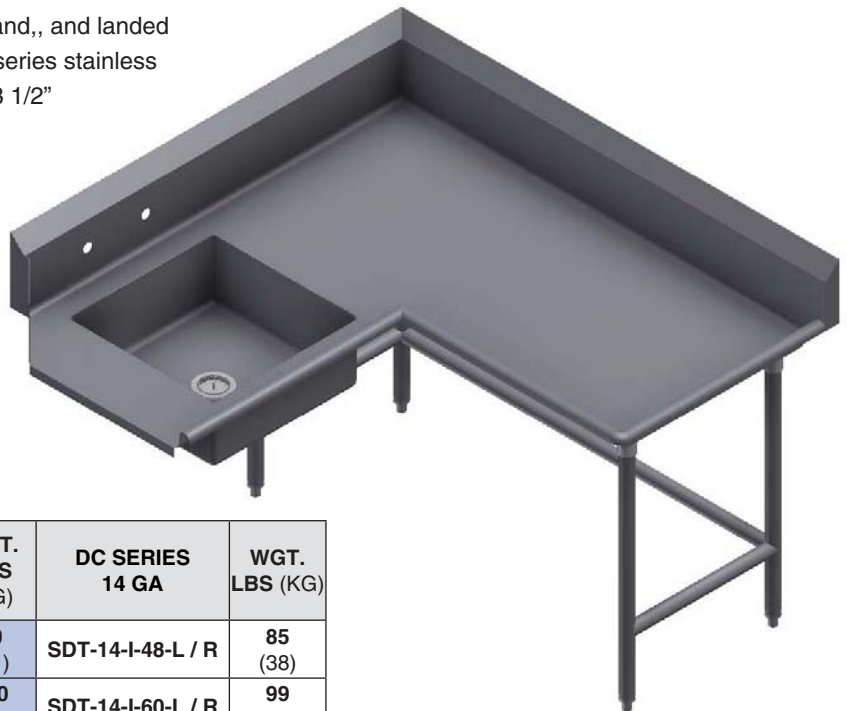

Island Soiled Dish Table
Left to Right (L)
Right to Left (R)

SIZE IN (MM)	LxW IN (MM)	SS SERIES 16 GA	WGT. LBS (KG)	DC SERIES 14 GA	WGT. LBS (KG)
48" (1219)	48"x30" (1219x762)	SDT-16-I-48-L / R	90 (41)	SDT-14-I-48-L / R	85 (38)
60" (1524)	60"x30" (1524x762)	SDT-16-I-60-L / R	100 (45)	SDT-14-I-60-L / R	99 (45)
72" (1829)	72"x30" (1829x762)	SDT-16-I-72-L / R	120 (55)	SDT-14-I-72-L / R	110 (50)
84" (2134)	84"x30" (2134x762)	SDT-16-I-84-L / R	130 (59)	SDT-14-I-84-L / R	132 (60)
96" (2438)	96"x30" (2438x762)	SDT-16-I-96-L / R	140 (64)	SDT-14-I-96-L / R	143 (65)
120" (3048)	120"x30" (3048x762)	SDT-16-I-120-L / R	160 (73)	SDT-14-I-120-L / R	154 (70)
144" (3658)	144"x30" (3658x762)	SDT-16-I-144-L / R	176 (79)	SDT-14-I-144-L / R	176 (80)

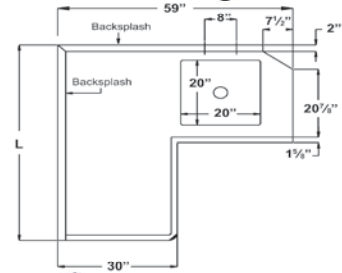

Island Clean Dish Table
Left to Right (L)
Right to Left (R)

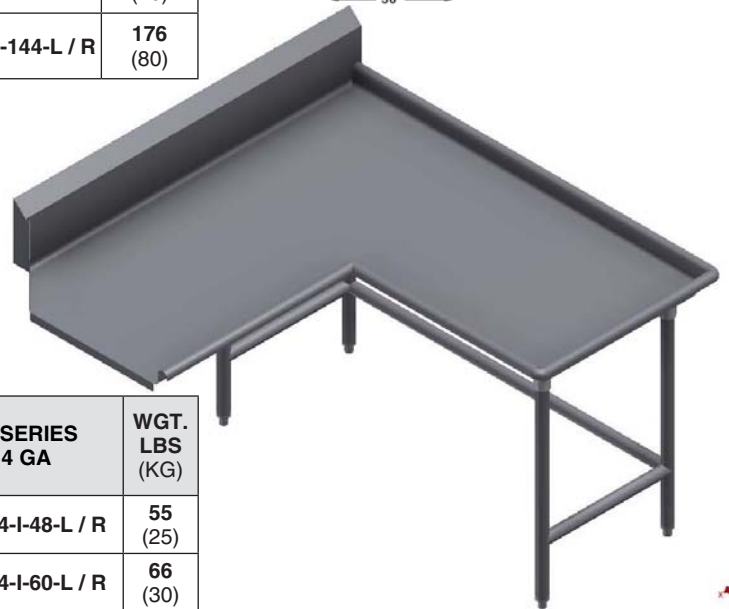

SIZE IN (MM)	LxW IN (MM)	SS SERIES 16 GA	WGT. LBS (KG)	DC SERIES 14 GA	WGT. LBS (KG)
48" (1219)	48"x30" (1219x762)	CDT-16-I-48-L / R	50 (23)	CDT-14-I-48-L / R	55 (25)
60" (1524)	60"x30" (1524x762)	CDT-16-I-60-L / R	60 (27)	CDT-14-I-60-L / R	66 (30)
72" (1829)	72"x30" (1829x762)	CDT-16-I-72-L / R	80 (36)	CDT-14-I-72-L / R	88 (40)
84" (2134)	84"x30" (2134x762)	CDT-16-I-84-L / R	100 (45)	CDT-14-I-84-L / R	110 (50)
96" (2438)	96"x30" (2438x762)	CDT-16-I-96-L / R	110 (50)	CDT-14-I-96-L / R	121 (55)
120" (3048)	120"x30" (3048x762)	CDT-16-I-120-L / R	140 (63)	CDT-14-I-120-L / R	150 (53)
144" (3658)	144"x30" (3658x762)	CDT-16-I-144-L / R	168 (76)	CDT-14-I-144-L / R	178 (80)

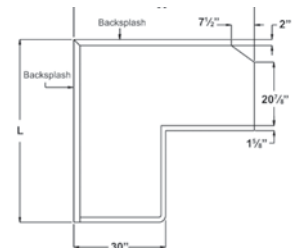



- 4 styles of tables available: straight, corner, island,, and landed
- Constructed of 16 GA (SS) or 14 GA (DC) 304 series stainless
- Soiled table has a 20"x20"x8"D bowl to accept 3 1/2" drain basket
- Backsplash punched to accept faucets on 8" centers
- Backsplash is 9" high, with 2" 45 degree return to wall
- 37" to top of rolled rim
- **Custom Sizes Available**

Landed Soiled Dish Table
Left to Right (L)
Right to Left (R)

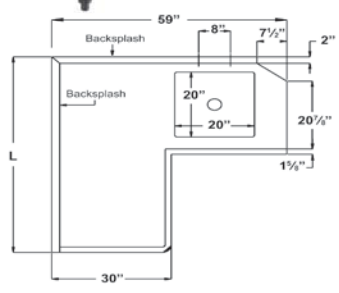

Standard Series - Standard
 16 Gauge, 304 series stainless steel dish tables and legs with stainless steel clad bullet feet. Fabricated bowls are 12" deep water level.

Design Consultant Series
 14 Gauge, 304 series stainless steel dish tables and legs with stainless steel clad bullet feet. Fabricated bowls are 14" deep water level.

SIZE IN (MM)	LxW IN (MM)	SS SERIES 16 GA	WGT. LBS (KG)	DC SERIES 14 GA	WGT. LBS (KG)
48" (1219)	48" x 30" (1219x762)	SDT-16-L-48-L / R	175 (80)	SDT-14-L-48-L / R	193 (88)
60" (1524)	60" x 30" (1524x762)	SDT-16-L-60-L / R	195 (89)	SDT-14-L-60-L / R	215 (98)
72" (1829)	72" x 30" (1829x762)	SDT-16-L-72-L / R	225 (102)	SDT-14-L-72-L / R	248 (113)
84" (2134)	84" x 30" (2134x762)	SDT-16-L-84-L / R	240 (109)	SDT-14-L-84-L / R	264 (120)
96" (2438)	96" x 30" (2438x762)	SDT-16-L-96-L / R	255 (116)	SDT-14-L-96-L / R	281 (128)
120" (3048)	120" x 30" (3048x762)	SDT-16-L-120-L / R	285 (130)	SDT-14-L-120-L / R	314 (143)
144" (3658)	144" x 30" (3658x762)	SDT-16-L-144-L / R	300 (135)	SDT-14-L-144-L / R	346 (158)



Undercounter Dish Table
Left (L)
Right (R)

- Use where space is limited
- Sanitary Stainless Steel Top is constructed of all welded 16 gauge stainless steel
- Stainless steel bullet feet that adjust 1".
- Pre-Rinse Bowl is 20"x20"x8"
- Includes angle to secure to dishwasher

SIZE IN (MM)	LxW IN (MM)	SS SERIES 16 GA	WGT. LBS (KG)
48" (1219)	48" x 30" (1219x762)	UDT-16-L-48-L / R	90 (41)
60" (1524)	60" x 30" (1524x762)	UDT-16-L-60-L / R	100 (45)
72" (1829)	72" x 30" (1829x762)	UDT-16-L-72-L / R	110 (50)

OPTION: WB18 18" Wall Brackets
 All Freight Class: 150



Sorting Shelves

- Designed for sorting of cups, glasses, and mugs.
- 16 gauge 304 stainless steel
- Mounts to backsplash and end roll of dish table
- Priced per linear foot



Double Table Mounted Shelf

Use Single shelf models below and add /DBL
MODEL: SSMDT-XXXX(length)/DBL

Sorting Shelf - Single Table Mounted

# RACKS	LxW IN (MM)	MODEL	WGT. LBS (KG)
1	22"x21" (559x533)	SSMDT2221/TB	20 (9)
2	42"x21" (1069x533)	SSMDT2242/TB	44 (20)
3	62"x21" (1575x533)	SSMDT2262/TB	60 (27)
4	82"x21" (2083x533)	SSMDT2282/TB	85 (38)

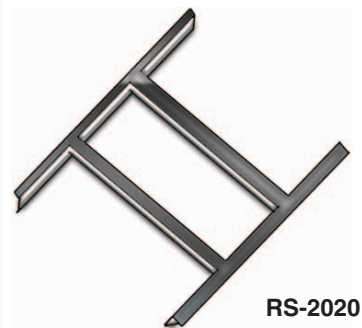

Sorting Shelf - Tubular Wall Mounted

# RACKS	LxW IN (MM)	MODEL	WGT. LBS (KG)
1	22"x21" (559x533)	SSWMDT2221	15 (7)
2	42"x21" (1069x533)	SSWMDT4221	23 (10)
3	62"x21" (1575x533)	SSWMDT6221	30 (14)
4	82"x21" (2083x533)	SSWMDT8221	38 (17)



Pre-Rinse Baskets & Rack Slide for Dish Tables

DEPTH IN (MM)	LxW IN (MM)	MODEL	WGT. LBS (KG)
2.5" (64)	19.5"x19.5" (495x495)	PRB-2020-2.5	15 (7)
6" (152)	19.5"x19.5" (495x495)	PRB-2020-6	25 (11)
RACK SLIDE			
---	19.5"x19.5" (495x495)	SSDRS-2020	4 (2)

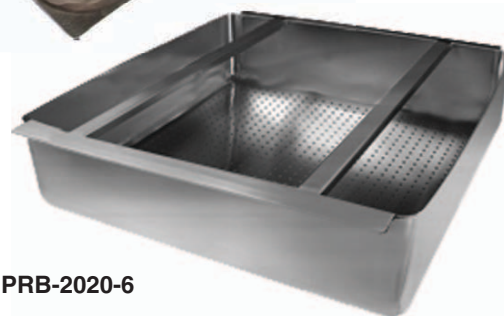
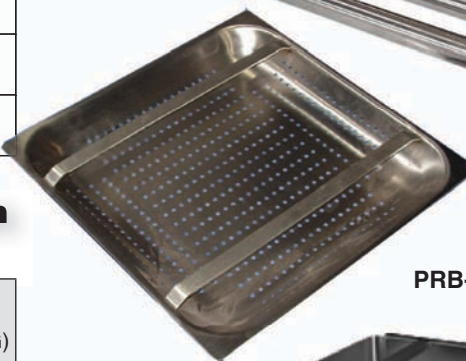

WinFab™ Dish Table Modifications

MODEL	DESCRIPTION	SOLD BY
Top Modifications		
WH-SCBL	Scrap Block Installed	each
WH-ASBH	Anti. Siphon Vacuum Breaker Holes	each
WH-WFJ	Welded field joint (by other)	each
WH-DSCB	Installation of Disposal Cone with 6"x9" control bracket, faucet holes <i>(Cone supplied by other)</i>	each
WH-DSCB14	Installation of Disposal Cone with 14"x16" control bracket, faucet holes <i>(Cone supplied by other)</i>	each
WH-CNBRK	Control Bracket 6"x9"	each
WH-CNBRK14	Control Bracket 14"x16"	each
WH-WATRG	Waste trough with removable basket - 2" deep	each
WH-COLLAR	Installation of collar with each 6"x9" control bracket (collar supplied by other)	
WH-COLLAR14	Installation of Collar with 14"x16" control bracket <i>(Collar supplied by other)</i>	each
WH-FAUCLOC	Special faucet hole location	each
WH-LAND	Landing Ledge	per. lin. ft
Underneath Modifications		
WH-HFLEG	H-Frame support leg	each
WH-CBH	Cutting board holder	each
WH-CNBRK14	Control Bracket 14"x16"	each
WS-SDDEAD	Sound Deadening	per lin.ft
Backsplash & Sidesplash Modifications		
WH-SPCU	Splash cutout	each
WH-BS13	Backsplash up to 13"	per lin. ft
WH-BS18	Backsplash up to 18"	per lin. ft
WH-SSP	Sink sidesplash	each
WH-SSI	Integrated sidesplash	per lin. ft
WH-ABS	Add 5" backsplash	per lin. ft
WH-PASST	Pass Thru	per lin. ft
<i>Dish Machine Sizing - Provide Model Number at Time of Order</i>		
WH-RLSBL	Relocate Sink Bowl	N/C
WH-NBS	Notch Backsplash for handle clearance	per lin. ft each

BRAND	MODIFICATION
American Dish Machine HT-25, SS-25	WH-NBS
Blakeslee D-8, D-9	WH-NBS
CMA 180, 44, 66	WH-RLSBL
Ecolab ES-4000, ES-4400, ES-6600, WH-Series	WH-RLSBL
Electrolux WT-65	WH-NBS
Hobart C-Series, CL-Series, CRS-Series, CCS-66//77/86/110, AM-15 (located in corner)	WH-RLSBL
AM-15	WH-NBS
Jackson AJ-Series, TS-Series, TSC-Series	WH-RLSBL
Meiko K-Series	WH-RLSBL
Stero	WH-RLSBL

WinFab™ Dish Table Accessories

MODEL	DESCRIPTION	SOLD BY
Sink Bowl Modifications		
WH-LVSB	Lever support bracket	each
WH-CT12XXXX	Custom bowl 12" deep	per sq. foot
WH-CT14XXXX	Custom bowl 14" deep	per sq. foot
WH-CT16XXXX	Custom bowl 16" deep	per sq. foot
WH-CTMOD	Modify bowl depth	each
Drainboard Modifications		
WH-EXDB	Extra drainboard	per lin. foot
WH-DBCTN	Corner turn for drainboard	each
WH-USDB	Undershelf drainboard	per lin. foot
Additional Crating Costs		
WH-CRATE	Complete Crating	per sink
WH-EXPCRATE	Export Crating	per sink
Stainless Steel Sink Cover for Sink Bowls		
WSA-SSC2020	S/S Sink cover 20"x20" bowl	each
Leg Accessories		
4497-3	Flanged stainless steel bullet foot	each
4471	Stainless steel clad foot	each
WH-RSB	Replacement rubber scrap block for WH-SCBL	each
WH-LWB	Leg to wall brace	each
<i>Faucets see page 24 & 25</i>		

**All Winholt Faucets are
LEAD FREE**

**Faucets and parts
sold separately.
See pages 24 & 25.**



Dish Table Modification Example Diagram

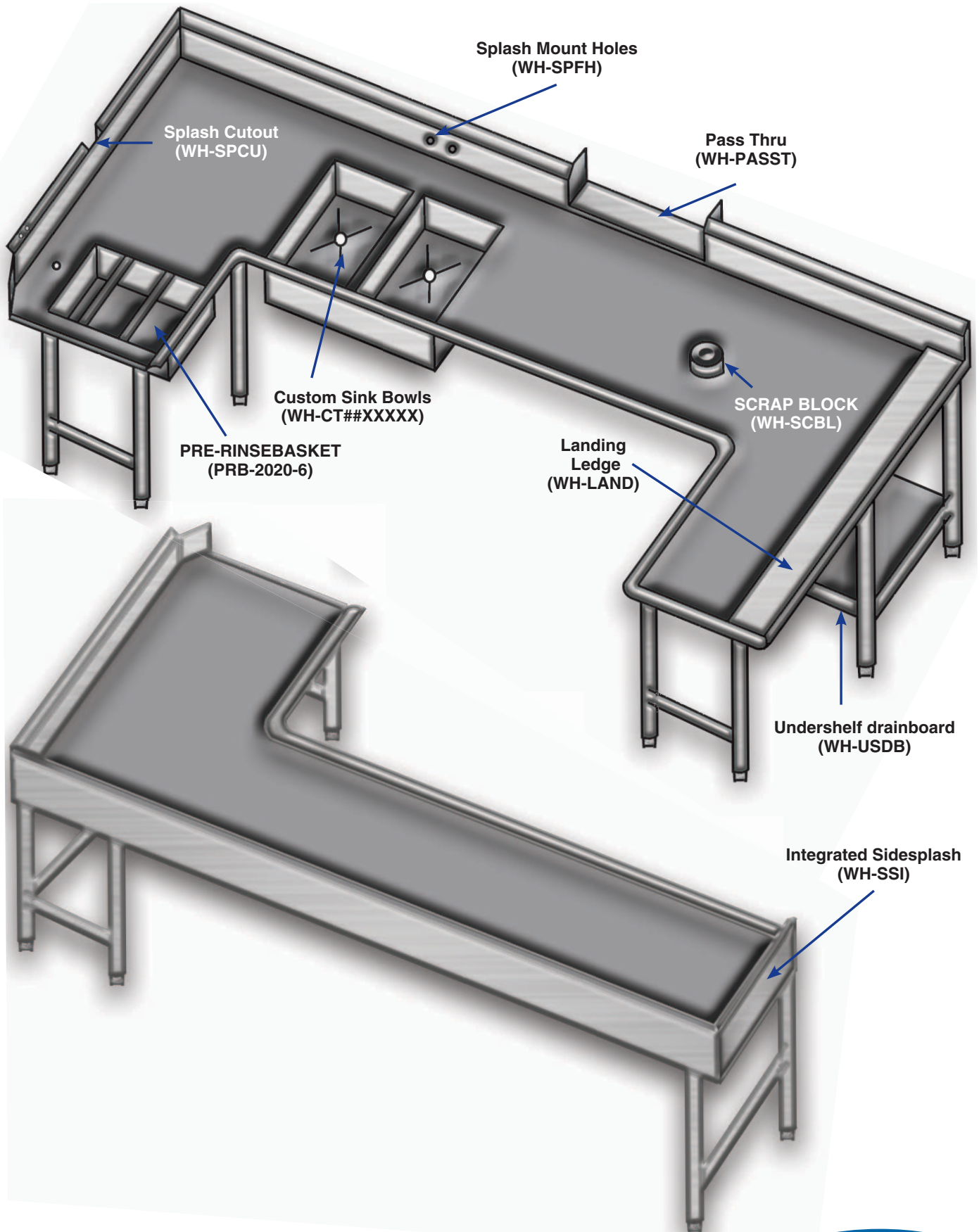

All Faucets are LEAD FREE



Standard Sink Faucets



Standard Pre-Rinse and Add-On Faucets



Premium Sink Faucets

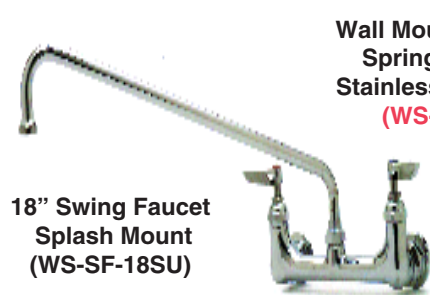

**Wall Mount Pre-Rinse
Spring Type with
Stainless Hose Cover
(WS-SPR-SU)**



Premium Pre-Rinse and Add-On Faucets

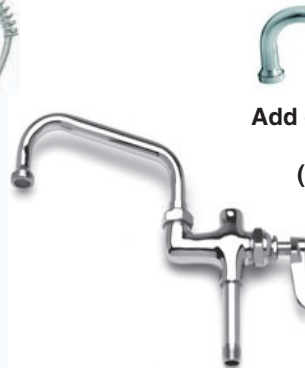

Sink Faucets

Pre-Rinse

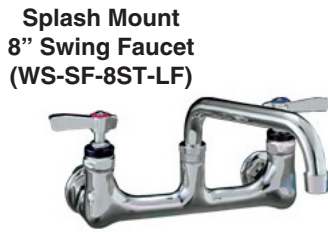

Hand Sink Faucets



Basket Drains



Basket Drain 1 1/2"
(WS-BD-15ST)

Basket Drain 3 1/2"
(WS-BD-35ST)



Standard Line - Lever Drain



Rotary Lever Waste Valve
with Flat Strainer
(WS-RLWV-ST)

Foot Pedals

Single Foot Pedal
(WS-FP-K252000)
for WHPS1110



Double Foot Pedals
(WS-FP-ST)
for WHPS1616

Knee Valves

Knee Valves
(WS-KV-ST)
for WWHS1410SP



Thermo Mixing Valve



Thermo
Mixing Valve
(WS-TMV-ST)
for WHPS1110

Water Station

Complete Water Station
(WS-CWS-K271000)



Glass Filler Repair Kit
(WS-GF-RKIT)

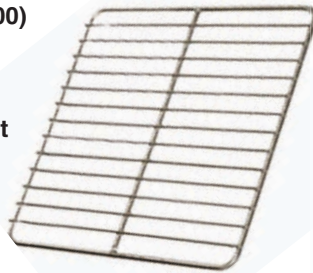

Replacement Wire Grid
(WS-RWG)



Glass Filler Faucet
(WS-GFF)



Water Station Sink
(WS-WSS)

Plumbing



P-Trap
(WS-P-TRAP)



Overflow Assembly
(WS-OA-E501000)

Service Faucet



Service Faucet
(WS-SFSV-65ST)
for Mop Sink

Soap Dispenser



Soap Dispenser
(WS-SD-ST)

Anatomy of a Work Table

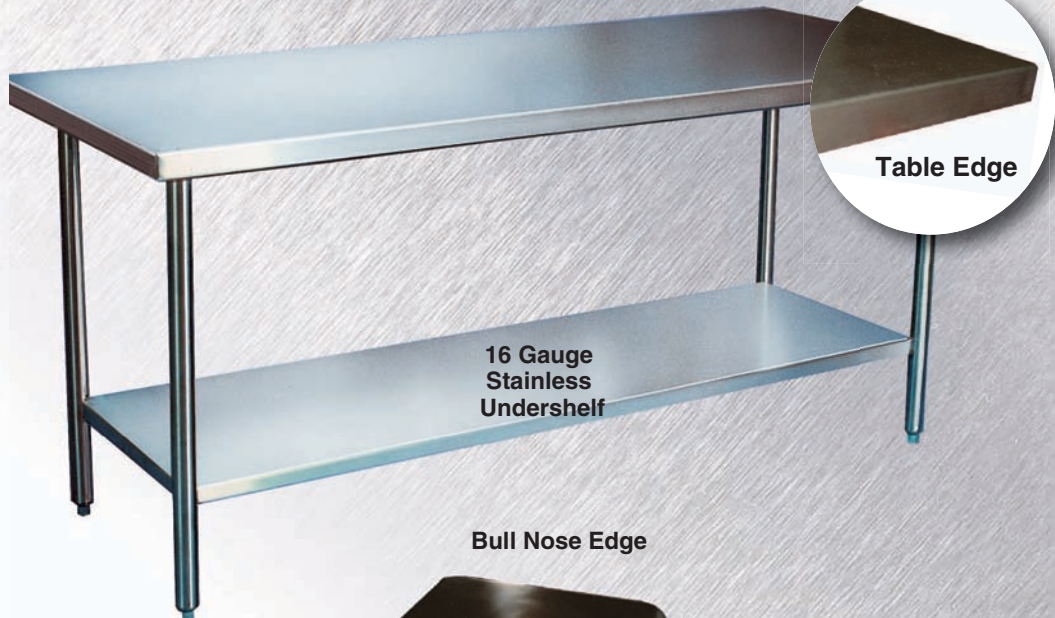
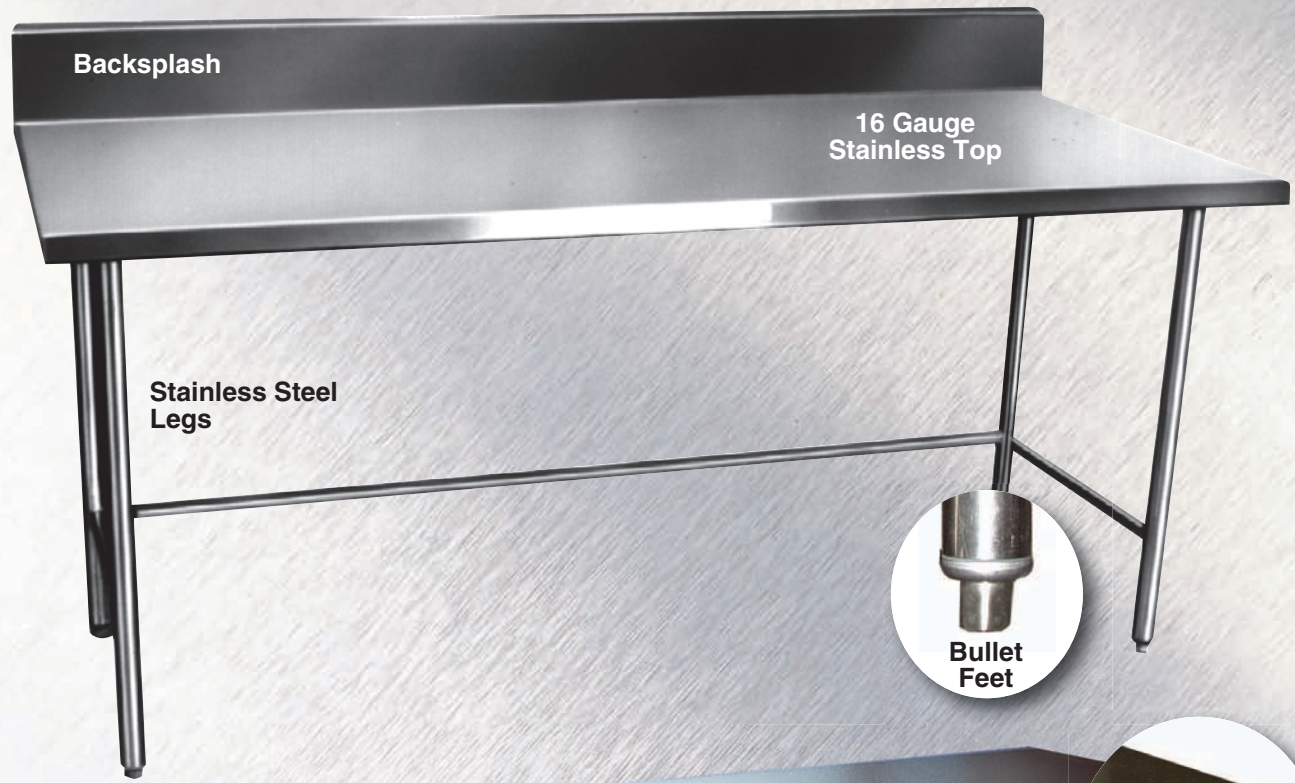
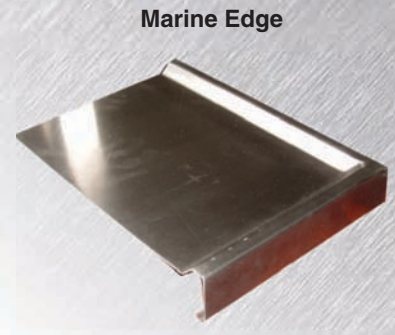
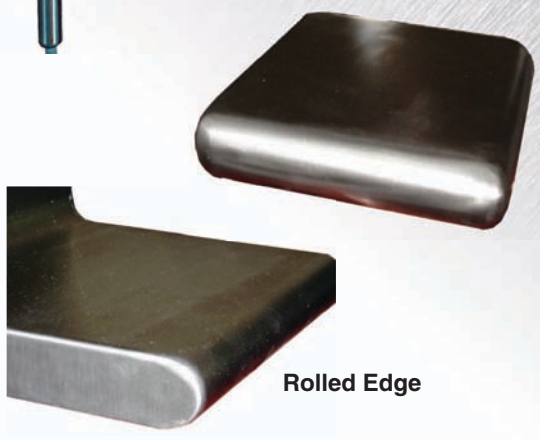
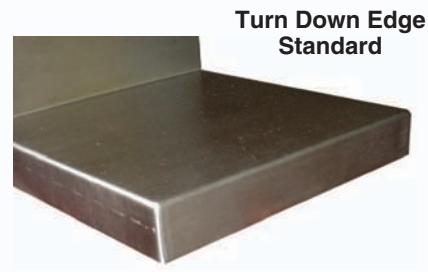
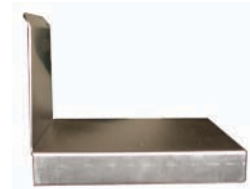

Table Edge Options



STANDARD Series Stainless Steel Work Tables with Backsplash

- All 16 gauge 304 series stainless steel top, shelves, and legs
- 6" Backsplash
- 1 5/8" diameter 16 gauge stainless steel tubing
- Adjustable height stainless steel bullet feet are standard
- Stainless steel hat channels deaden sound and reinforce the top to maintain a level work surface
- Undershef is 18 gauge
- *96" tables are standard with six legs



STANDARD Series Backsplash

WIDTH IN (MM)	LENGTH IN (MM)	STANDARD SERIES 16 Gauge	WGT LBS (KG)
24" (610)	36" (914)	DTB-2436	59 (27)
	48" (1219)	DTB-2448	71 (32)
	60" (1524)	DTB-2460	82 (37)
	72" (1829)	DTB-2472	94 (43)
	84" (2134)	DTB-2484	110 (50)
30" (762)	36" (914)	DTB-3036	65 (29)
	48" (1219)	DTB-3048	78 (35)
	60" (1524)	DTB-3060	91 (41)
	72" (1829)	DTB-3072	104 (47)
	84" (2134)	DTB-3084	120 (54)
36" (914)	36" (914)	DTB-3636	70 (32)
	48" (1219)	DTB-3648	79 (36)
	60" (1524)	DTB-3660	90 (41)
	72" (1829)	DTB-3672	105 (48)
	84" (2134)	DTB-3684	125 (57)
	96" (2438)	DTB-3696*	141 (64)

Freight Class: 200



Stainless Steel Hat Channels highlighted in red are standard on all Winholt tables.

Hat Channels deaden sound and reinforce the top to maintain a level work surface

STANDARD Series Stainless Steel Work Tables with Stainless Steel Undershef & Backsplash

WIDTH IN (MM)	LENGTH IN (MM)	STANDARD SERIES 16 Gauge	WGT LBS (KG)
24" (610)	36" (914)	DTSB-2436	65 (29)
	48" (1219)	DTSB-2448	81 (37)
	60" (1524)	DTSB-2460	95 (43)
	72" (1829)	DTSB-2472	111 (50)
	84" (2134)	DTSB-2484	131 (59)
	96" (2438)	DTSB-2496	147 (67)
30" (762)	36" (914)	DTSB-3036	73 (33)
	48" (1219)	DTSB-3048	90 (109)
	60" (1524)	DTSB-3060	109 (49)
	72" (1829)	DTSB-3072	126 (57)
	84" (2134)	DTSB-3084	142 (64)
	96" (2438)	DTSB-3096	168 (76)
36" (914)	36" (914)	DTSB-3636	81 (37)
	48" (1219)	DTSB-3648	95 (43)
	60" (1524)	DTSB-3660	111 (50)
	72" (1829)	DTSB-3672	132 (60)
	84" (2134)	DTSB-3684	151 (68)
	96" (2438)	DTSB-3696*	177 (80)

Freight Class: 200



**STANDARD Series
Stainless Steel Poly Top Work Tables**



DPTR



**STANDARD SERIES
Backslash**



DPTB

- All 16 gauge 304 series stainless steel tops, shelves, legs and backslash
- Table height 34"
- 5" high backslash
- Adjustable height stainless steel bullet feet are standard
- Legs and cross bracing are 1-5/8" diameter 16 gauge stainless steel tubing
- Stainless steel hat channels deaden sound and reinforce the top to maintain a level work surface
- 18 gauge stainless steel undershelf (DPTB/DPTSB SERIES)
- Poly top is 5/8" thick and sectioned for easy removal. Polytop clips are removeable. 3/4" poly tops available upon request
- *96" long tables are standard with six legs

WIDTH IN (MM)	LENGTH IN (MM)	STANDARD SERIES Open Base	WGT LBS (KG)	STANDARD SERIES Open Base w/ Backslash	WGT LBS (KG)
24" (610)	36" (914)	DPTR-2436	54 (24)	DPTB-2436	59 (27)
	48" (1219)	DPTR-2448	64 (29)	DPTB-2448	71 (32)
	60" (1524)	DPTR-2460	74 (34)	DPTB-2460	82 (37)
	72" (1829)	DPTR-2472	84 (38)	DPTB-2472	94 (43)
	84" (2134)	DPTR-2484	94 (43)	DPTB-2484	110 (50)
30" (762)	96" (2438)	DPTR-2496	114 (54)	DPTB-2496	126 (57)
	36" (914)	DPTR-3036	60 (24)	DPTB-3036	65 (29)
	48" (1219)	DPTR-3048	72 (33)	DPTB-3048	78 (35)
	60" (1524)	DPTR-3060	83 (38)	DPTB-3060	91 (41)
	72" (1829)	DPTR-3072	95 (43)	DPTB-3072	104 (47)
36" (914)	84" (2134)	DPTR-3084	115 (52)	DPTB-3084	120 (54)
	96" (2438)	DPTR-3096	126 (57)	DPTB-3096	139 (63)
	36" (914)	DPTR-3636	69 (31)	DPTB-3636	70 (32)
	48" (1219)	DPTR-3648	79 (36)	DPTB-3648	79 (36)
	60" (1524)	DPTR-3660	92 (42)	DPTB-3660	90 (41)
36" (914)	72" (1829)	DPTR-3672	105 (48)	DPTB-3672	105 (48)
	84" (2134)	DPTR-3684	116 (53)	DPTB-3684	125 (57)
	96" (2438)	DPTR-3696*	140 (63)	DPTB-3696*	135 (61)

**STANDARD Series
Stainless Steel Poly Top Work Tables
with Undershelf**

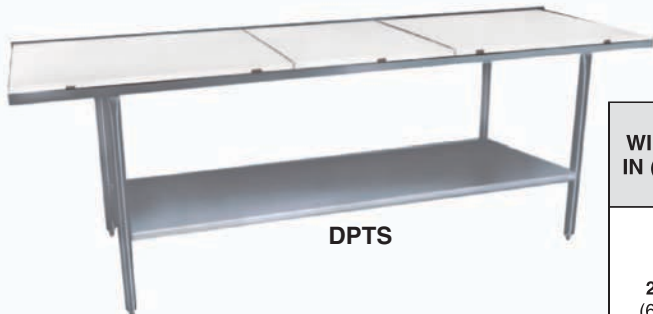

DPTS

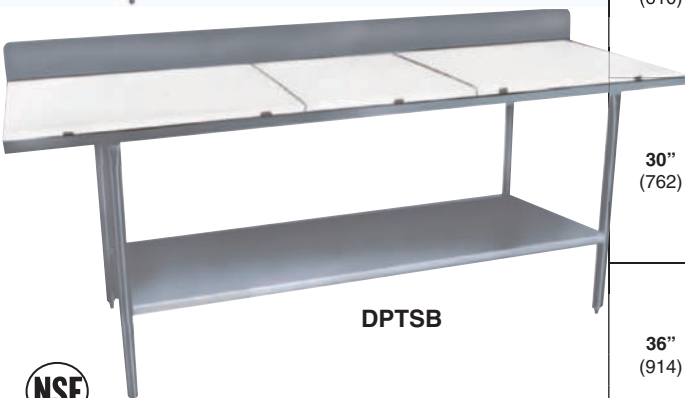

DPTSB

WIDTH IN (MM)	LENGTH IN (MM)	STANDARD SERIES w/Undershelf	WGT LBS (KG)	STANDARD SERIES w/Undershelf & Backslash	WGT LBS (KG)
24" (610)	36" (914)	DPTS-2436	60 (27)	DPTSB-2436	65 (29)
	48" (1219)	DPTS-2448	73 (33)	DPTSB-2448	81 (37)
	60" (1524)	DPTS-2460	86 (39)	DPTSB-2460	95 (43)
	72" (1829)	DPTS-2472	100 (45)	DPTSB-2472	111 (50)
	84" (2134)	DPTS-2484	120 (54)	DPTSB-2484	131 (59)
30" (762)	96" (2438)	DPTS-2496	134 (61)	DPTSB-2496	147 (67)
	36" (914)	DPTS-3036	73 (33)	DPTSB-3036	73 (33)
	48" (1219)	DPTS-3048	84 (38)	DPTSB-3048	90 (109)
	60" (1524)	DPTS-3060	100 (45)	DPTSB-3060	109 (49)
	72" (1829)	DPTS-3072	116 (53)	DPTSB-3072	126 (57)
36" (914)	84" (2134)	DPTS-3084	136 (62)	DPTSB-3084	142 (64)
	96" (2438)	DPTS-3096	155 (70)	DPTSB-3096	168 (76)
	36" (914)	DPTS-3636	82 (37)	DPTSB-3636	81 (37)
	48" (1219)	DPTS-3648	94 (43)	DPTSB-3648	95 (43)
	60" (1524)	DPTS-3660	113 (51)	DPTSB-3660	111 (50)
36" (914)	72" (1829)	DPTS-3672	131 (59)	DPTSB-3672	132 (60)
	84" (2134)	DPTS-3684	150 (68)	DPTSB-3684	151 (68)
	96" (2438)	DPTS-3696*	160 (75)	DPTSB-3696*	162 (73)



All Freight Class: 200

800.444.3595 | 516.921.0538 fax | www.winholt.com

**STANDARD Series
Stainless Steel Maple Wood
Top Tables**

- Frame constructed of 16 gauge stainless steel
- 34" in height with stainless steel bullet feet that adjust 1"
- 3/4" Hard laminated maple wood top with edge grain electronically bonded
- 2" maple is available upon request
- *96" long tables are standard with six legs
- 18 gauge stainless steel undershelf



WTS Series



WTSS Series

WIDTH IN (MM)	LENGTH IN (MM)	Standard SERIES 16 Gauge	WGT LBS (KG)
36" (914)	48" (1219)	WTS-3648	100 (45)
	60" (1524)	WTS-3660	120 (54)
	72" (1829)	WTS-3672	140 (64)
	96" (2438)	WTS-3696*	160 (73)
With Undershelves			
36" (914)	48" (1219)	WTSS-3648	120 (54)
	60" (1524)	WTSS-3660	140 (64)
	72" (1829)	WTSS-3672	160 (73)
	96" (2438)	WTSS-3696*	200 (91)

**STANDARD Series
Enclosed Base Tables**

- Sanitary stainless steel top is constructed of all welded 16 gauge stainless steel.
- 5" High stainless steel backsplash no return
- Sliding Doors - 36"-72" Tables have 2 Door, 84"-144" Tables have 4 Doors

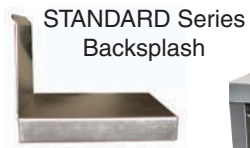

STANDARD Series Backsplash



Economy design available upon request!

WIDTH IN (MM)	LENGTH IN (MM)	Standard SERIES 16 Gauge	WGT LBS (KG)
24" (610)	36" (914)	STCT-BD2436	104 (47)
	48" (1219)	STCT-BD2448	120 (54)
	60" (1524)	STCT-BD2460	140 (63)
	72" (1829)	STCT-BD2472	166 (75)
	84" (2134)	STCT-BD2484	190 (86)
	96" (2438)	STCT-BD2496	211 (96)
30" (762)	36" (914)	STCT-BD3036	118 (54)
	48" (1219)	STCT-BD3048	133 (60)
	60" (1524)	STCT-BD3060	156 (71)
	72" (1829)	STCT-BD3072	186 (84)
	84" (2134)	STCT-BD3084	205 (93)
	96" (2438)	STCT-BD3096*	234 (106)

All Freight Class: 150



Caster Option for all work tables



Specify option by adding suffix to model numbers listed below.

- Casters Option for All Work Tables**
- /M2LC: 4 leg table, 4 casters, includes 2 locking
 - /M4LC: 4 leg table, 4 casters, includes 4 locking
 - /M3LC: 6 leg table, 6 casters, includes 3 locking
 - /M6LC: 6 leg table, 6 casters, includes 6 locking



Stainless Steel Work Tables



- All welded construction
- 16 GA (SS Series) and 14 GA (DC Series) stainless steel
- All TIG welded and shipped set up. High polish finish
- Adjustable height stainless steel bullet feet are standard. Height 34"
- Legs and cross bracing are 1 5/8" diameter 16 gauge stainless steel tubing
- Stainless steel hat channels deaden sound and reinforce the top to maintain a level work surface
- *96" long tables are standard with six legs



Stainless Steel Hat Channels highlighted in red are standard on all Winholt tables.

Hat Channels deaden sound and reinforce the top to maintain a level work surface



WIDTH IN (MM)	LENGTH IN (MM)	FOODSERVICE SERIES 16 Gauge	WGT LBS (KG)	CONSULTANT SERIES 18 Gauge	WGT LBS (KG)	
24" (610)	36" (914)	DTR-2436	54 (24)	DTR-2436/14GA	95 (43)	
	48" (1219)	DTR-2448	64 (29)	DTR-2448/14GA	110 (50)	
	60" (1524)	DTR-2460	74 (34)	DTR-2460/14GA	120 (55)	
	72" (1829)	DTR-2472	84 (38)	DTR-2472/14GA	130 (59)	
	84" (2134)	DTR-2484	94 (43)	DTR-2484/14GA	170 (77)	
30" (762)	96" (2438)	DTR-2496	114 (54)	DTR-2496/14GA	180 (82)	
	36" (914)	DTR-3036	60 (24)	DTR-3036/14GA	105 (48)	
	48" (1219)	DTR-3048	72 (33)	DTR-3048/14GA	120 (55)	
	60" (1524)	DTR-3060	83 (38)	DTR-3060/14GA	130 (59)	
	72" (1829)	DTR-3072	95 (43)	DTR-3072/14GA	140 (64)	
36" (914)	84" (2134)	DTR-3084	115 (52)	DTR-3084/14GA	185 (84)	
	96" (2438)	DTR-3096	126 (57)	DTR-3096/14GA	200 (91)	
	36" (914)	DTR-3636	69 (31)	DTR-3636/14GA	120 (55)	
	48" (1219)	DTR-3648	79 (36)	DTR-3648/14GA	130 (59)	
	60" (1524)	DTR-3660	92 (42)	DTR-3660/14GA	145 (66)	
36" (914)	72" (1829)	DTR-3672	105 (48)	DTR-3672/14GA	160 (73)	
	84" (2134)	DTR-3684	116 (53)	DTR-3684/14GA	200 (91)	
	96" (2438)	DTR-3696*	140 (63)	DTR-3696/14GA	220 (100)	
	With Undershef					
	24" (610)	36" (914)	DTS-2436	60 (27)	DTS-2436/14GA	95 (43)
48" (1219)		DTS-2448	73 (33)	DTS-2448/14GA	110 (50)	
60" (1524)		DTS-2460	86 (39)	DTS-2460/14GA	120 (55)	
72" (1829)		DTS-2472	100 (45)	DTS-2472/14GA	135 (61)	
84" (2134)		DTS-2484	120 (54)	DTS-2484/14GA	170 (77)	
30" (762)	96" (2438)	DTS-2496	134 (61)	DTS-2496/14GA	185 (84)	
	36" (914)	DTS-3036	73 (33)	DTS-3036/14GA	115 (52)	
	48" (1219)	DTS-3048	84 (38)	DTS-3048/14GA	120 (55)	
	60" (1524)	DTS-3060	100 (45)	DTS-3060/14GA	130 (59)	
	72" (1829)	DTS-3072	116 (53)	DTS-3072/14GA	140 (64)	
36" (914)	84" (2134)	DTS-3084	136 (62)	DTS-3084/14GA	185 (84)	
	96" (2438)	DTS-3096	155 (70)	DTS-3096/14GA	200 (91)	
	36" (914)	DTS-3636	82 (37)	DTS-3636/14GA	125 (57)	
	48" (1219)	DTS-3648	94 (43)	DTS-3648/14GA	135 (61)	
	60" (1524)	DTS-3660	113 (51)	DTS-3660/14GA	145 (66)	
36" (914)	72" (1829)	DTS-3672	131 (59)	DTS-3672/14GA	160 (73)	
	84" (2134)	DTS-3684	150 (68)	DTS-3684/14GA	200 (91)	
	96" (2438)	DTS-3696*	177 (80)	DTS-3696/14GA	220 (100)	

Foodservice Series

16 Gauge, 304 series stainless steel top, undershelf, and legs with stainless steel clad bullet feet. Standard with boxed backsplash.

Design Consultant Series

14 Gauge, 304 series stainless steel top, undershelf, and legs with stainless steel clad bullet feet. Standard with boxed backsplash.

OPTION: WB18 18" WALL BRACKETS
Freight Class: 200



Stainless Steel Work Tables with Backsplash



Foodservice & Design Series
Boxed Backsplash
Shown with optional rolled edge



WIDTH IN (MM)	LENGTH IN (MM)	FOODSERVICE SERIES 16 Gauge	WGT LBS (KG)	CONSULTANT SERIES 18 Gauge	WGT LBS (KG)
24" (610)	36" (914)	DTBB-2436	90 (41)	DTBB-2436/14GA	90 (41)
	48" (1219)	DTBB-2448	100 (45)	DTBB-2448/14GA	100 (45)
	60" (1524)	DTBB-2460	110 (50)	DTBB-2460/14GA	110 (50)
	72" (1829)	DTBB-2472	120 (55)	DTBB-2472/14GA	120 (55)
	84" (2134)	DTBB-2484	145 (66)	DTBB-2484/14GA	145 (66)
	96" (2438)	DTBB-2496	160 (73)	DTBB-2496/14GA	160 (73)
30" (762)	36" (914)	DTBB-3036	100 (45)	DTBB-3036/14GA	100 (45)
	48" (1219)	DTBB-3048	115 (52)	DTBB-3048/14GA	115 (52)
	60" (1524)	DTBB-3060	145 (66)	DTBB-3060/14GA	145 (66)
	72" (1829)	DTBB-3072	155 (70)	DTBB-3072/14GA	155 (70)
	84" (2134)	DTBB-3084	170 (77)	DTBB-3084/14GA	170 (77)
	96" (2438)	DTBB-3096	185 (84)	DTBB-3096/14GA	185 (84)
36" (914)	36" (914)	DTBB-3636	105 (48)	DTBB-3636/14GA	105 (48)
	48" (1219)	DTBB-3648	115 (52)	DTBB-3648/14GA	115 (52)
	60" (1524)	DTBB-3660	145 (66)	DTBB-3660/14GA	145 (66)
	72" (1829)	DTBB-3672	155 (70)	DTBB-3672/14GA	155 (70)
	84" (2134)	DTBB-3684	170 (77)	DTBB-3684/14GA	170 (77)
	96" (2438)	DTBB-3696*	185 (84)	DTBB-3696/14GA	185 (84)
With Undershaft					
24" (610)	36" (914)	DTSBB-2436	100 (45)	DTSBB-2436/14GA	100 (45)
	48" (1219)	DTSBB-2448	115 (52)	DTSBB-2448/14GA	115 (52)
	60" (1524)	DTSBB-2460	135 (61)	DTSBB-2460/14GA	135 (61)
	72" (1829)	DTSBB-2472	150 (68)	DTSBB-2472/14GA	150 (68)
	84" (2134)	DTSBB-2484	175 (80)	DTSBB-2484/14GA	180 (82)
	96" (2438)	DTSBB-2496	200 (91)	DTSBB-2496/14GA	200 (91)
30" (762)	36" (914)	DTSBB-3036	110 (50)	DTSBB-3036/14GA	110 (50)
	48" (1219)	DTSBB-3048	130 (59)	DTSBB-3048/14GA	130 (59)
	60" (1524)	DTSBB-3060	140 (64)	DTSBB-3060/14GA	140 (64)
	72" (1829)	DTSBB-3072	165 (75)	DTSBB-3072/14GA	165 (75)
	84" (2134)	DTSBB-3084	198 (89)	DTSBB-3084/14GA	200 (91)
	96" (2438)	DTSBB-3096	215 (98)	DTSBB-3096/14GA	215 (98)
36" (914)	36" (914)	DTSBB-3636	120 (55)	DTSBB-3636/14GA	125 (57)
	48" (1219)	DTSBB-3648	135 (61)	DTSBB-3648/14GA	140 (64)
	60" (1524)	DTSBB-3660	145 (66)	DTSBB-3660/14GA	155 (70)
	72" (1829)	DTSBB-3672	170 (77)	DTSBB-3672/14GA	180 (82)
	84" (2134)	DTSBB-3684	205 (93)	DTSBB-3684/14GA	220 (100)
	96" (2438)	DTSBB-3696*	220 (100)	DTSBB-3696/14GA	235 (107)

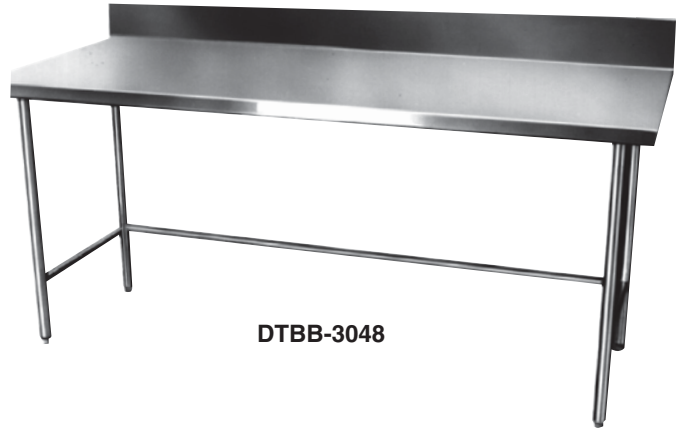

DTBB-3048

Caster Option for all work tables



Specify option by adding suffix to model numbers listed below.

- /M2LC: 4 leg table, 4 casters, includes 2 locking
- /M4LC: 4 leg table, 4 casters, includes 4 locking
- /M3LC: 6 leg table, 6 casters, includes 3 locking
- /M6LC: 6 leg table, 6 casters, includes 6 locking

OPTION: WB18 18" WALL BRACKETS
Freight Class: 200

Enclosed Base Tables - Flat Top



STCT-HD

- Sanitary stainless steel top is constructed of all welded 16 gauge stainless steel
- 34" Height with stainless steel bullet feet that adjust 1"
- Available with a stationary mid-shelf
- **Hinged Doors** - 36"-72", 84"-120" 4 Doors, 144", 6 Doors
- **Sliding Doors** - 48"-72", 2 Doors, 4"-144", 4 Doors
- **Custom Sizes Available**



STCT



STCT-D

WIDTH IN (MM)	LENGTH IN (MM)	Open Table with No Shelf	Open Table With Shelf	WGT LBS (KG)	Table with Hinged Doors No Shelf	Table with Hinged Doors With Shelf	Table with Sliding Doors No Shelf	Table with Sliding Doors With Shelf	WGT LBS (KG)
24" (610)	36" (914)	STCT-2436	STCT-2436/M	75 (34)	STCT-HD-2436	STCT-HD-2436/M	STCT-D-2436	STCT-D-2436/M	90 (41)
	48" (1219)	STCT-2448	STCT-2448/M	100 (45)	STCT-HD-2448	STCT-HD-2448/M	STCT-D-2448	STCT-D-2448/M	120 (55)
	60" (1524)	STCT-2460	STCT-2460/M	125 (57)	STCT-HD-2460	STCT-HD-2460/M	STCT-D-2460	STCT-D-2460/M	150 (68)
	72" (1829)	STCT-2472	STCT-2472/M	150 (68)	STCT-HD-2472	STCT-HD-2472/M	STCT-D-2472	STCT-D-2472/M	180 (82)
	84" (2134)	STCT-2484	STCT-2484/M	175 (80)	STCT-HD-2484	STCT-HD-2484/M	STCT-D-2484	STCT-D-2484/M	210 (95)
	96" (2438)	STCT-2496	STCT-2496/M	200 (91)	STCT-HD-2496	STCT-HD-2496/M	STCT-D-2496	STCT-D-2496/M	240 (109)
30" (762)	36" (914)	STCT-3036	STCT-3036/M	85 (38)	STCT-HD-3036	STCT-HD-3036/M	STCT-D-3036	STCT-D-3036/M	95 (43)
	48" (1219)	STCT-3048	STCT-3048/M	110 (50)	STCT-HD-3048	STCT-HD-3048/M	STCT-D-3048	STCT-D-3048/M	125 (57)
	60" (1524)	STCT-3060	STCT-3060/M	135 (61)	STCT-HD-3060	STCT-HD-3060/M	STCT-D-3060	STCT-D-3060/M	155 (70)
	72" (1829)	STCT-3072	STCT-3072/M	160 (73)	STCT-HD-3072	STCT-HD-3072/M	STCT-D-3072	STCT-D-3072/M	185 (84)
	84" (2134)	STCT-3084	STCT-3084/M	185 (84)	STCT-HD-3084	STCT-HD-3084/M	STCT-D-3084	STCT-D-3084/M	215 (98)
	96" (2438)	STCT-3096	STCT-3096/M	210 (95)	STCT-HD-3096	STCT-HD-3096/M	STCT-D-3096	STCT-D-3096/M	245 (111)
36" (914)	36" (914)	STCT-3636	STCT-3636/M	100 (45)	STCT-HD-3636	STCT-HD-3636/M	STCT-D-3636	STCT-D-3636/M	124 (56)
	48" (1219)	STCT-3648	STCT-3648/M	132 (60)	STCT-HD-3648	STCT-HD-3648/M	STCT-D-3648	STCT-D-3648/M	150 (68)
	60" (1524)	STCT-3660	STCT-3660/M	162 (74)	STCT-HD-3660	STCT-HD-3660/M	STCT-D-3660	STCT-D-3660/M	186 (85)
	72" (1829)	STCT-3672	STCT-3672/M	192 (87)	STCT-HD-3672	STCT-HD-3672/M	STCT-D-3672	STCT-D-3672/M	222 (101)
	84" (2134)	STCT-3684	STCT-3684/M	222 (101)	STCT-HD-3684	STCT-HD-3684/M	STCT-D-3684	STCT-D-3684/M	258 (117)
	96" (2438)	STCT-3696	STCT-3696/M	252 (115)	STCT-HD-3696	STCT-HD-3696/M	STCT-D-3696	STCT-D-3696/M	294 (134)

OPTION: WB18 18" WALL BRACKETS
Freight Class: 150



Enclosed Base Tables - 5" High Boxed Backsplash

- Sanitary stainless steel top is constructed of all welded 16 gauge stainless steel
- 34" Height with stainless steel bullet feet that adjust 1"
- Available with a stationary mid-shelf
- **Hinged Doors** - 36"-72", 84"-120" 4 Doors, 144", 6 Doors
- **Sliding Doors** - 48"-72", 2 Doors, 4"-144", 4 Doors
- 5" High stainless boxed backsplash with 45 degree return
- **Custom Sizes Available**



STCT-BBD /M

Boxed Backsplash



STCT-BBHD /M



STCT-BB /M

WIDTH IN (MM)	LENGTH IN (MM)	Open Table with No Shelf	Open Table With Shelf	WGT LBS (KG)	Table with Hinged Doors No Shelf	Table with Hinged Doors With Shelf	Table with Sliding Doors No Shelf	Table with Sliding Doors With Shelf	WGT LBS (KG)
24" (610)	36" (914)	STCT-BB2436	STCT-BB2436/M	80 (36)	STCT-BBHD-2436H	STCT-BBHD-2436/M	STCT-BBD-2436	STCT-BBD-2436/M	95 (43)
	48" (1219)	STCT-BB2448	STCT-BB2448/M	105 (48)	STCT-BBHD-2448	STCT-BBHD-2448/M	STCT-BBD-2448	STCT-BBD-2448/M	125 (57)
	60" (1524)	STCT-BB2460	STCT-BB2460/M	130 (59)	STCT-BBHD-2460	STCT-BBHD-2460/M	STCT-BBD-2460	STCT-BBD-2460/M	155 (70)
	72" (1829)	STCT-BB2472	STCT-BB2472/M	155 (70)	STCT-BBHD-2472	STCT-BBHD-2472/M	STCT-BBD-2472	STCT-BBD-2472/M	185 (84)
	84" (2134)	STCT-BB2484	STCT-BB2484/M	180 (82)	STCT-BBHD-2484	STCT-BBHD-2484/M	STCT-BBD-2484	STCT-BBD-2484/M	215 (98)
	96" (2438)	STCT-BB2496	STCT-BB2496/M	205 (93)	STCT-BBHD-2496	STCT-BBHD-2496/M	STCT-BBD-2496	STCT-BBD-2496/M	245 (111)
30" (762)	36" (914)	STCT-BB3036	STCT-BB3036/M	90 (41)	STCT-BBHD-3036	STCT-BBHD-3036/M	STCT-BBD-3036	STCT-BBD-3036/M	110 (50)
	48" (1219)	STCT-BB3048	STCT-BB3048/M	115 (52)	STCT-BBHD-3048	STCT-BBHD-3048/M	STCT-BBD-3048	STCT-BBD-3048/M	140 (64)
	60" (1524)	STCT-BB3060	STCT-BB3060/M	140 (64)	STCT-BBHD-3060	STCT-BBHD-3060/M	STCT-BBD-3060	STCT-BBD-3060/M	170 (77)
	72" (1829)	STCT-BB3072	STCT-BB3072/M	165 (175)	STCT-BBHD-3072	STCT-BBHD-3072/M	STCT-BBD-3072	STCT-BBD-3072/M	200 (91)
	84" (2134)	STCT-BB3084	STCT-BB3084/M	190 (86)	STCT-BBHD-3084	STCT-BBHD-3084/M	STCT-BBD-3084	STCT-BBD-3084/M	230 (105)
	96" (2438)	STCT-BB3096	STCT-BB3096/M	215 (98)	STCT-BBHD-3096	STCT-BBHD-3096/M	STCT-BBD-3096	STCT-BBD-3096/M	260 (118)
36" (914)	36" (914)	STCT-BB3636	STCT-BB3636/M	108 (49)	STCT-BBHD-3636	STCT-BBHD-3636/M	STCT-BBD-3636	STCT-BBD-3636/M	128 (58)
	48" (1219)	STCT-BB3648	STCT-BB3648/M	138 (63)	STCT-BBHD-3648	STCT-BBHD-3648/M	STCT-BBD-3648	STCT-BBD-3648/M	168 (76)
	60" (1524)	STCT-BB3660	STCT-BB3660/M	168 (76)	STCT-BBHD-3660	STCT-BBHD-3660/M	STCT-BBD-3660	STCT-BBD-3660/M	204 (93)
	72" (1829)	STCT-BB3672	STCT-BB3672/M	198 (90)	STCT-BBHD-3672	STCT-BBHD-3672/M	STCT-BBD-3672	STCT-BBD-3672/M	240 (109)
	84" (2134)	STCT-BB3684	STCT-BB3684/M	228 (104)	STCT-BBHD-3684	STCT-BBHD-3684/M	STCT-BBD-3684	STCT-BBD-3684/M	276 (125)
	96" (2438)	STCT-BB3696	STCT-BB3696/M	258 (117)	STCT-BBHD-3696	STCT-BBHD-3696/M	STCT-BBD-3696	STCT-BBD-3696/M	312 (142)

OPTION: WB18 18" WALL BRACKETS
Freight Class: 150





STCT-B15D

Enclosed Base Tables 1-1/2" Backsplash

- Sanitary stainless steel top is constructed of all welded 16 gauge stainless steel
- 34" Height with stainless steel bullet feet that adjust 1"
- Available with a stationary mid-shelf
- 1.5" High stainless steel backplash no return
- **Custom Sizes Available**



STCT-B15



STCT-B15HD

WIDTH IN (MM)	LENGTH IN (MM)	Open Table with No Shelf	Open Table With Shelf	WGT LBS (KG)	Table with Hinged Doors No Shelf	Table with Hinged Doors With Shelf	Table with Sliding Doors No Shelf	Table with Sliding Doors With Shelf	WGT LBS (KG)
24" (610)	36 (914)	STCT-B15-2436	STCT-B15-2436/M	75 (34)	STCT-B15HD-2436	STCT-B15HD-2436/M	STCT-B15D-2436	STCT-B15D-2436/M	90 (41)
	48 (1219)	STCT-B15-2448	STCT-B15-2448/M	100 (45)	STCT-B15HD-2448	STCT-B15HD-2448/M	STCT-B15D-2448	STCT-B15D-2448/M	120 (55)
	60 (1524)	STCT-B15-2460	STCT-B15-2460/M	125 (57)	STCT-B15HD-2460	STCT-B15HD-2460/M	STCT-B15D-2460	STCT-B15D-2460/M	150 (68)
	72 (1829)	STCT-B15-2472	STCT-B15-2472/M	150 (68)	STCT-B15HD-2472	STCT-B15HD-2472/M	STCT-B15D-2472	STCT-B15D-2472/M	180 (82)
	84 (2134)	STCT-B15-2484	STCT-B15-2484/M	175 (80)	STCT-B15HD-2484	STCT-B15HD-2484/M	STCT-B15D-2484	STCT-B15D-2484/M	210 (95)
	96 (2438)	STCT-B15-2496	STCT-B15-2496/M	200 (91)	STCT-B15HD-2496	STCT-B15HD-2496/M	STCT-B15D-2496	STCT-B15D-2496/M	240 (109)
30" (762)	36 (914)	STCT-B15-3036	STCT-B15-3036/M	85 (38)	STCT-B15HD-3036	STCT-B15HD-3036/M	STCT-B15D-3036	STCT-B15D-3036/M	95 (43)
	48 (1219)	STCT-B15-3048	STCT-B15-3048/M	110 (50)	STCT-B15HD-3048	STCT-B15HD-3048/M	STCT-B15D-3048	STCT-B15D-3048/M	125 (57)
	60 (1524)	STCT-B15-3060	STCT-B15-3060/M	135 (61)	STCT-B15HD-3060	STCT-B15HD-3060/M	STCT-B15D-3060	STCT-B15D-3060/M	155 (70)
	72 (1829)	STCT-B15-3072	STCT-B15-3072/M	160 (73)	STCT-B15HD-3072	STCT-B15HD-3072/M	STCT-B15D-3072	STCT-B15D-3072/M	185 (84)
	84 (2134)	STCT-B15-3084	STCT-B15-3084/M	185 (84)	STCT-B15HD-3084	STCT-B15HD-3084/M	STCT-B15D-3084	STCT-B15D-3084/M	215 (98)
	96 (2438)	STCT-B15-3096	STCT-B15-3096/M	210 (95)	STCT-B15HD-3096	STCT-B15HD-3096/M	STCT-B15D-3096	STCT-B15D-3096/M	245 (111)
36" (914)	36 (914)	STCT-B15-3636	STCT-B15-3636/M	100 (45)	STCT-B15HD-3636	STCT-B15HD-3636/M	STCT-B15D-3636	STCT-B15D-3636/M	124 (56)
	48 (1219)	STCT-B15-3648	STCT-B15-3648/M	132 (60)	STCT-B15HD-3648	STCT-B15HD-3648/M	STCT-B15D-3648	STCT-B15D-3648/M	150 (68)
	60 (1524)	STCT-B15-3660	STCT-B15-3660/M	162 (74)	STCT-B15HD-3660	STCT-B15HD-3660/M	STCT-B15D-3660	STCT-B15D-3660/M	186 (85)
	72 (1829)	STCT-B15-3672	STCT-B15-3672/M	192 (87)	STCT-B15HD-3672	STCT-B15HD-3672/M	STCT-B15D-3672	STCT-B15D-3672/M	222 (101)
	84 (2134)	STCT-B15-3684	STCT-B15-3684/M	222 (101)	STCT-B15HD-3684	STCT-B15HD-3684/M	STCT-B15D-3684	STCT-B15D-3684/M	258 (117)
	96 (2438)	STCT-B15-3696	STCT-B15-3696/M	252 (115)	STCT-B15HD-3696	STCT-B15HD-3696/M	STCT-B15D-3696	STCT-B15D-3696/M	294 (134)

OPTION: WB18 18" WALL BRACKETS
Freight Class: 150



Table Modification Example Diagram

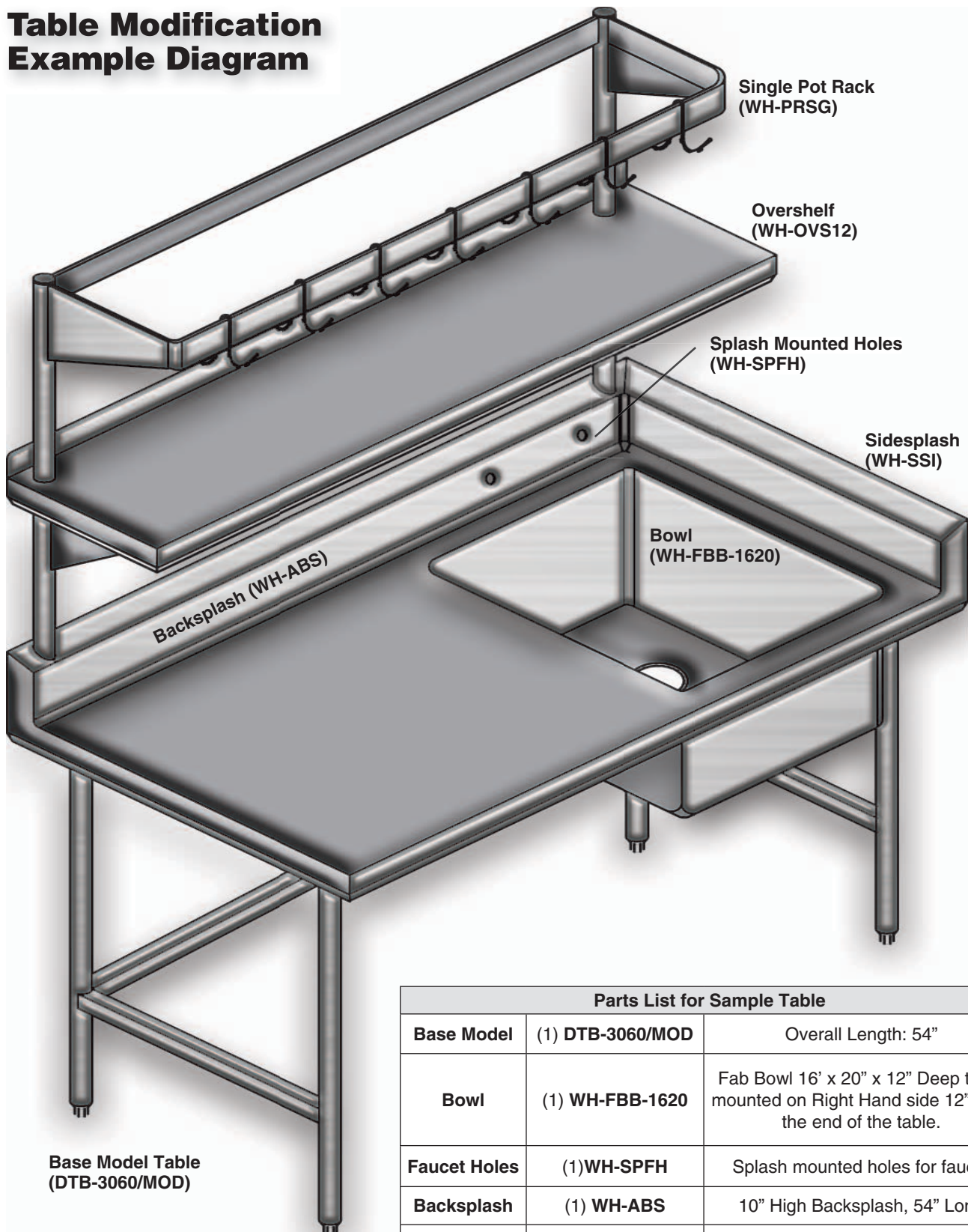

Base Model Table (DTB-3060/MOD)

Parts List for Sample Table		
Base Model	(1) DTB-3060/MOD	Overall Length: 54"
Bowl	(1) WH-FBB-1620	Fab Bowl 16' x 20" x 12" Deep to be mounted on Right Hand side 12" from the end of the table.
Faucet Holes	(1)WH-SPFH	Splash mounted holes for faucet
Backsplash	(1) WH-ABS	10" High Backsplash, 54" Long
Right Side Splash	(1) WH-SSI	10" Right Hand Sidesplash, 30" Long
Pot Rack	(1) WH-PRSG	Pot Rack Single
Overshelf	(1) WH-OVS12	Overshelf Solid 12" Wide, 54" Long. Overshelf is splash mounted

Table Edge Options

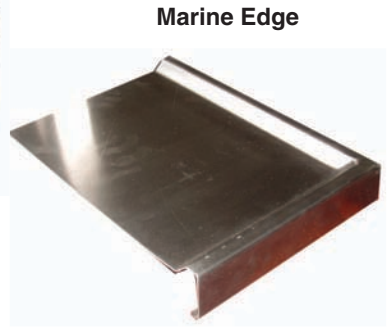
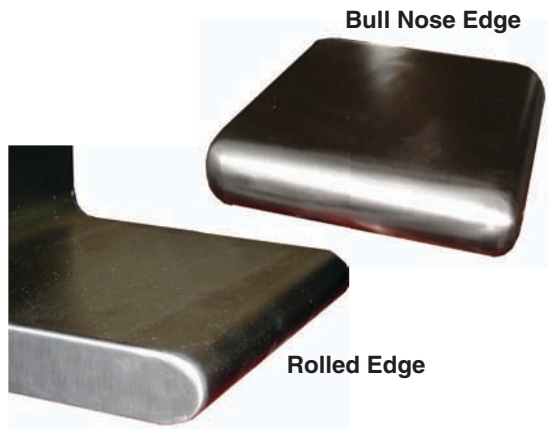
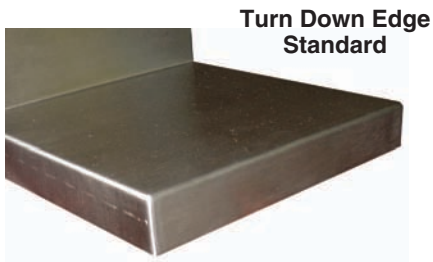

Flanged Stainless Steel Feet
(4497-3)



Table Casters with Brakes
(/M2LC, /M4LC, /M3LC, /M6LC)



**Shown with Undershelf and
Rotary Lever Waste Valve**

End Splash
(WH-ESP)

**Integrated
Single Bowl**
(WHPFB-101410/KIT)



Grommet Hole
(WH-GROMMET)



Trash Chute
(WH-TRASHCH)



Cup Dispenser Hole
(WH-DISPENSE)

Urn Trough
(WH-URN)



Stainless Side Panel
(WH-SP24 / WH-SP30)

Not all modifications shown.

WinFab™ Table Modifications

MODEL	DESCRIPTION	SOLD BY
Integrated Single Bowl Welded in Top		
WH-PFB-101410/KIT	10" x 14" x 10" Deep**	each
WH-PFB-141612/KIT	14" x 16" x 12" Deep	each
WH-PFB-16208/KIT	16" x 20" x 8" Deep	each
WH-PFB-162012/KIT	16" x 20" x 12" Deep	each
WH-PFB-181812/KIT	18" x 18" x 12" Deep	each
WH-PFB-182412/KIT	18" x 24" x 12" Deep	each
WH-PFB-20208/KIT	20" x 20" x 8" Deep*	each
WH-PFB-202012/KIT	20" x 20" x 12" Deep*	each
WH-PFB-242412/KIT	24" x 24" x 12" Deep**	each
WH-OMIT-FAUCET	Omit Faucet Kit	each
<ul style="list-style-type: none"> Single sink bowl comes with 8" Deck Mount 4" O.C Swing Spout Faucet and Basket Drain 10" x 14" sink bowl comes with 3 1/2" spout deck mounted 4" O.C. goose-neck faucet. 		
*Table must be 30" or wider to be installed.		
**Table must be 36" or wider to be installed.		
Integrated Double Bowl Welded in Table Top		
WH-PFB2-101410/KIT	10" x 14" x 10" Deep **	each
WH-PFB2-141612/KIT	14" x 16" x 12" Deep	each
WH-PFB2-16208/KIT	16" x 20" x 8" Deep	each
WH-PFB2-162012/KIT	16" x 20" x 12" Deep	each
WH-PFB2-181812/KIT	18" x 18" x 12" Deep	each
WH-PFB2-182412/KIT	18" x 24" x 12" Deep	each
WH-PFB2-20208/KIT	20" x 20" x 8" Deep *	each
WH-PFB2-202012/KIT	20" x 20" x 12" Deep *	each
WH-PFB2-242412/KIT	24" x 24" x 12" Deep **	each
WH-OMIT2-FAUCET	Omit Faucet Kit	each
<ul style="list-style-type: none"> Double sink bowl comes with 12" Deck Mount 4" O.C Swing Spout Faucet and Basket Drain 10" x 14" sink bowl comes with 12" swing spout faucet mounted 4" O.C. gooseneck faucet. 		
*Table must be 30" or wider to be installed.		
**Table must be 36" or wider to be installed.		
Top Modifications		
<i>Edges</i>		
WH-RE	Rolled edge	per lin. foot
WH-BE	Bullnose edge	per lin. foot
WH-MARCT	Marine edge	per lin. foot
WH-MITER	Mitered edge	per lin. foot
WH-MIRROR	Mirrored Edge	per lin. foot
WH-URN	Urn trough	per lin. foot
<i>Top Cut Outs</i>		
WH-TCOU36	Top cut out up to 36" length	each
WH-TCOO36	Top cut out over 36" length	each
WH-RTCO	Round top cut out	each
WH-TRASHCH	Trash chute	each
WH-NOTTOPT	Notch top for buyout unit	each
WH-GROMMET	2" hole for grommet for appliance cord, specify hole location	each
WH-WELL	Cutout for Cold or Hot Well	each
WH-DISPENSE	Hole for side cup dispenser dimensions to be provided by dealer for hole	each
<i>Top Modifications</i>		
WH-PASST	Simple pass thru	per lin. foot
WH-STEPDOWN	Step down to 24"	each
WH-WFJ	Welded field joint by other in field	each
WH-REINF	Reinforced Top or Undershelf	per lin. foot
WH-SDDEAD	Sound Deadening	per lin. foot
<i>Electrical Outlets (no wiring)</i>		
WH-DUPLEX	Duplex Electrical Outlet in Splash	each
WH-DUPLEXGFI	Duplex Elec. Outlet GFI Specify Location	each
WH-DUPLEXUND	Duplex Electrical Outlet Under Table Top	each
WH-DEO	Doghouse Electrical Outlet Box	each
WH-HO	Hubble Outlet	each
<i>Additional Crating</i>		
WH-CRATE	Complete Crating	per table
WH-EXPCRATE	Export Crating	per table

MODEL	DESCRIPTION	SOLD BY
Backsplash & Sidesplash Modifications		
WH-SPCU	Splash cutout	each
WH-BS13	Backsplash up to 13" SM Series	per lin. foot
WH-BS18	Backsplash up to 18" SM Series	per lin. foot
WH-BSBB13	Backsplash up to 13" FS/DC Series	per lin. foot
WH-BSBB18	Backsplash up to 18" FS/DC Series	per lin. foot
WH-SSP	Sink sidesplash	each
WH-SSI	Integrated sidesplash - SM Series	per lin. foot
WH-SSIIBB	Integrated sidesplash - FS/DC Series	per lin. foot
WH-ABSBB	Add 5" backsplash - FS/DC Series	per lin. foot
WH-ABS10BB	Add 10" backsplash - FS/DC Series	per lin. foot
WH-ECRSPL	Enclosed Rearsplash - FS/DC Series	per lin. foot
WH-ESP	Endsplash - FS/DC Series	per lin. foot
WH-CNRS	Column notch in rearsplash	each
WH-SP24	Side panel 24" deep	each
WH-SP30	Side panel 30" deep	each
WH-CEO	Cutout for electrical outlet by others - Specify type when ordering. Installation by others. - FS/DC Series Only	each
WH-DUP	Cutout for duplex outlet by others - Specify type when ordering. Installation by others. - FS/DC Series Only	each
WH-HUB	Cutout for Hubble outlet by others - Specify type when ordering. Installation by others. - FS/DC Series Only	each
WH-ASBH	Anti. Siphon Vacuum Breaker for Sink	each
Base Modifications		
WH-WHCG	Work height change	each
WH-REINF	Reinforced Top or Undershelf	per lin. foot
WH-RMFAP	Removable Front access panel	per lin. foot
WH-RBP	Removable back panel	each
WH-DW	Drawer Warmer Ready Slot	each
WH-INTPART	Interior partition 2.5"x30"	each
WH-REMCP	Removable kick plate	per lin. foot
Doors		
WH-SLIDDR	Sliding Door	each
WH-HGDR	Hinged Door	each
WH-HG24DR	24" Wide Hinged Door	each
WH-PLH	Pad lock hasp	each
WH-DL	Door Locks	each
Cut Outs		
WH-PCO	12"x12" Cut-Out for Plumbing	each
WH-URTCO	Undershelf round top cut out	each
WH-GROMMET	2" hole for grommet for appliance cord, specify hole location.	each
Undershelf		
WH-AJUS	Adjustable undershelf cabinet base only	per lin. foot
WH-USTU	Undershelf 1 1/2" turn up	per lin. foot
Leg Accessories		
4497-3	Flanged stainless steel bullet foot	each
4471	Stainless steel clad foot	each
4497-3	Flanged stainless steel bullet foot	each
/M2LC	4 leg table, 4 casters, 2 with locks	per table
/M3LC	6 leg table, 6 casters, 3 with locks	per table
/M4LC	4 leg table, 4 casters, 4 with locks	per table
/M6LC	6 leg table, 6 casters, 6 with locks	per table
WH-LWB	Leg to wall brace	each
Overshelves		
WH-OVS10	Overshelf 10" Wide	per lin. foot
WH-OVS12	Overshelf 12" Wide	per lin. foot
WH-OVS15	Overshelf 15" Wide	per lin. foot
WH-OVS18	Overshelf 18" Wide	per lin. foot
**All 16 gauge 304 stainless steel includes uprights and hardware. Specify mid mount, rear mount, and splash mount when ordering.		
Pot Racks		
WH-PRSG	Pot Rack Single	per lin. foot
WH-PRDO	Pot Rack Double	per lin. foot
**All 16 gauge 304 stainless steel includes uprights and hardware. Specify mid mount, rear mount, and splash mount when ordering.		

Table Modifications

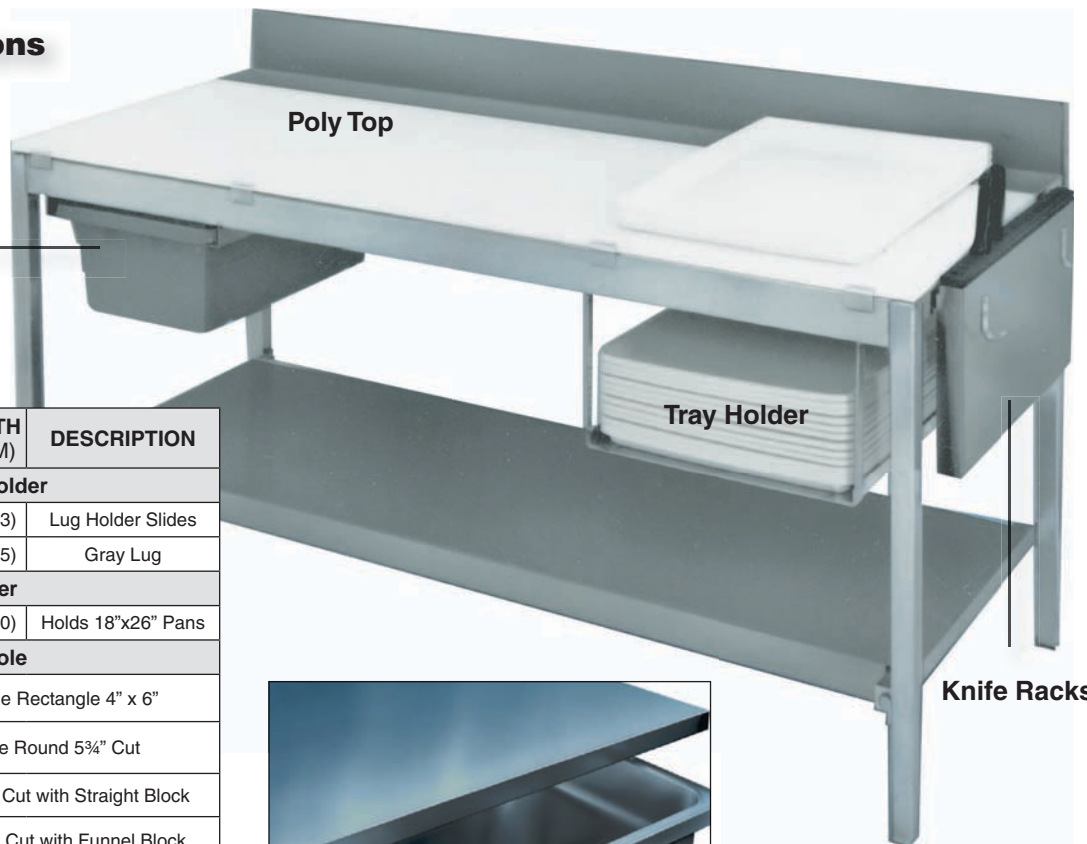

Lug Holders

Poly Top

Tray Holder

Knife Racks



MODEL	WIDTH IN (MM)	LENGTH IN (MM)	DESCRIPTION
Lug & Lug Holder			
ALD-1826	24" (610)	32" (813)	Lug Holder Slides
WHPL-8-GY	16" (406)	25" (635)	Gray Lug
Tray Holder			
ALPH-1224	19" (483)	24" (610)	Holds 18"x26" Pans
Scupper Hole			
416410	Scupper Hole Rectangle 4" x 6"		
416428	Scrap Hole Round 5 3/4" Cut		
416444	Scrap Hole 5 3/4" Cut with Straight Block		
416461	Scrap Hole 5 3/4" Cut with Funnel Block		
Stainless Drawer with Poly Slides			
SD-1 / 24	15" (381)	20" (508)	Plastic Slide Drawer with S.S. Front and S.S. Pan for 24" wide table
SD-1 / 30	20" (508)	20" (508)	Plastic Slide Drawer with S.S. Front and S.S. Pan for 30" wide table
SD-1 / 36	20" (508)	20" (508)	Plastic Slide Drawer with S.S. Front and S.S. Pan for 36" wide table
SD-2	20" (508)	20" (508)	S.S. Enclosed Drawer with S.S. Front and S.S. Pan
Roller Bearing Slide Drawer			
SD-3RB/24	15" (381)	20" (508)	pan for 24" wide table
SD-3RB	20" (508)	20" (508)	pan for 30" x 36" wide table
Aluminum Table Mount Style Boat Racks & Dividers			
ALB-48T	15" (381)	48" (1219)	16 lb (7)kg
ALB-60T	15" (381)	60" (1524)	18 lb (9)kg
ALB-72T	15" (381)	72" (1829)	21 lb (10)kg
ALB-96T	15" (381)	96" (2438)	24 lb (11)kg
Aluminum Wall Mount Style Boat Racks & Dividers			
ALB-48W	15" (381)	48" (1219)	13 lb (6)kg
ALB-60W	15" (381)	60" (1524)	15 lb (7)kg
ALB-72W	15" (381)	72" (1829)	18 lb (8)kg
ALB-96W	15" (381)	96" (2438)	21 lb (10)kg
ALDIV-1218	12" (305)	18" (1219)	Aluminum Divider
Knife Racks & Knife Clips			
KR-14	14" (356)		
KR-23	23" (584)		
KR-CLIPS	3/4"		
Cutting Boards & Replacement Poly Tops See Page 136			

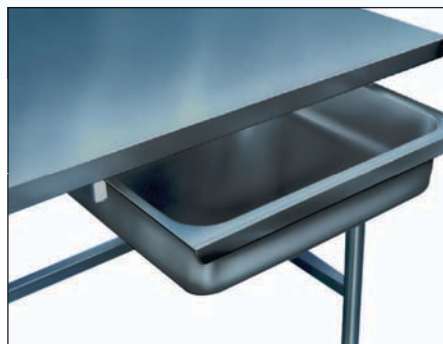

Stainless Steel Drawer SDRB-1 / 24



Aluminum Table Mounted Boat Rack



Roller Bearing Slide Draw SD-3RB / 24



Cutting Boards & Replacement Poly Tops
See Page 136

Freight Class: 70

Work Station Cantilever Shelving Stainless Steel

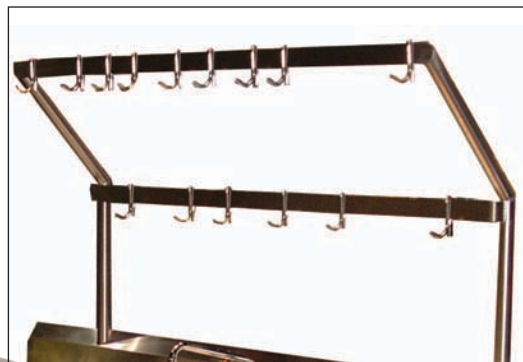

Pot Rack - Single & Double Splash Mount Double shown (WH-PRDO)

Wood Top Table shown with two undershelves and double rear mounted shelves



Work Station Shelving Stainless Steel

LENGTH IN (MM)	10" WIDE	WGT LBS (KG)	12" WIDE	WGT LBS (KG)	15" WIDE	WGT LBS (KG)	18" WIDE	WGT LBS (KG)
36" (914)	WH-COS-1036	9 (4)	WH-COS-1236	18 (8)	WH-COS-1536	15 (7)	WH-COS-1836	30 (14)
48" (1219)	WH-COS-1048	12 (6)	WH-COS-1248	24 (12)	WH-COS-1548	20 (8)	WH-COS-1848	34 (15)
60" (1524)	WH-COS-1060	15 (7)	WH-COS-1260	30 (14)	WH-COS-1560	25 (11)	WH-COS-1860	37 (17)
72" (1829)	WH-COS-1072	18 (8)	WH-COS-1272	36 (16)	WH-COS-1572	30 (14)	WH-COS-1872	46 (21)
84" (2134)	WH-COS-1084	21 (9)	WH-COS-1284	42 (18)	WH-COS-1584	35 (16)	WH-COS-1884	50 (23)
96" (2438)	WH-COS-1096	25 (11)	WH-COS-1296	50 (22)	WH-COS-1596	40 (18)	WH-COS-1896	55 (25)

Workstation Pot Racks (PR) & Utensil Rack (UR)

LENGTH IN (MM)	POT RACK SPLASHMOUNT	WGT LBS (KG)	POT RACK REAR MOUNT	WGT LBS(KG)	POT RACK CENTER MOUNT	WGT LBS (KG)	UTENSIL RACK	WGT LBS (KG)
36" (914)	WH-PRSG-36-SM	30 (14)	WH-PRSG-36-RM	30 (14)	WH-PRSG-36-CM	30 (14)	WH-UR-36	9 (4)
48" (1219)	WH-PRSG-48-SM	34 (15)	WH-PRSG-48-RM	34 (15)	WH-PRSG-48-CM	34 (15)	WH-UR-48	12 (6)
60" (1524)	WH-PRSG-60-SM	37 (17)	WH-PRSG-60-RM	37 (17)	WH-PRSG-60-CM	37 (17)	WH-UR-60	15 (7)
72" (1829)	WH-PRSG-72-SM	46 (21)	WH-PRSG-72-RM	46 (21)	WH-PRSG-72-CM	46 (21)	WH-UR-72	18 (8)
84" (2134)	WH-PRSG-84-SM	50 (23)	WH-PRSG-84-RM	50 (23)	WH-PRSG-84-CM	50 (23)	WH-UR-84	21 (9)
96" (2438)	WH-PRSG-96-SM	55 (25)	WH-PRSG-96-RM	55 (25)	WH-PRSG-96-CM	55 (25)	WH-UR-96	25 (11)

Single and Double Table Mounted Shelves - All Welded



- Stainless steel shelf is 304 series 16 GA undershelf
- Three depths available 10", 12", 15"
- Mounted either front (FM), center (CM), or rear (RM)
- Rear mount (RM) shelves have 1" turn up
- When ordering please specify suffix to the model number
- Custom Sizes Available

**NOTE: WHEN ORDERING
PLEASE SPECIFY SUFFIX TO THE MODEL NUMBER:
Example: WH-OVS-S-1584/RM
FM Front Mount
CM Center Mount
RM Rear Mount**

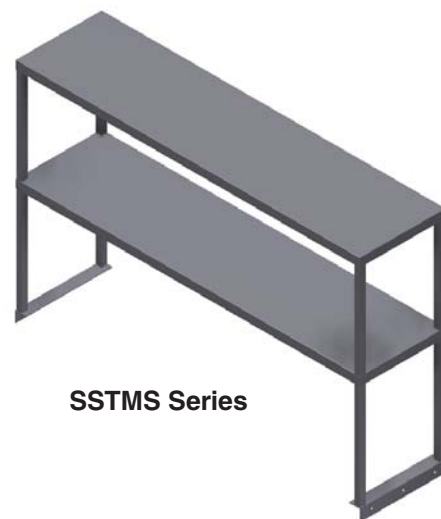

SSTMS Series

WIDTH IN (MM)	LENGTH IN (MM)	SINGLE OVERSHELF	WGT LBS (KG)	DOUBLE OVERSHELF	WGT LBS (KG)
10" (254)	36" (914)	SSTMS-1036	9 (4)	SSTMDS-1036	18 (8)
	48" (1219)	SSTMS-1048	12 (6)	SSTMDS-1048	24 (12)
	60" (1524)	SSTMS-1060	15 (7)	SSTMDS-1060	30 (14)
	72" (1829)	SSTMS-1072	18 (8)	SSTMDS-1072	36 (16)
	84" (2134)	SSTMS-1084	21 (9)	SSTMDS-1084	42 (18)
	96" (2438)	SSTMS-1096	25 (11)	SSTMDS-1096	50 (22)
12" (305)	36" (914)	SSTMS-1236	12 (6)	SSTMDS-1236	24 (12)
	48" (1219)	SSTMS-1248	16 (7)	SSTMDS-1248	32 (14)
	60" (1524)	SSTMS-1260	20 (8)	SSTMDS-1260	40 (16)
	72" (1829)	SSTMS-1272	24 (11)	SSTMDS-1272	48 (22)
	84" (2134)	SSTMS-1284	28 (13)	SSTMDS-1284	56 (26)
	96" (2438)	SSTMS-1296	32 (14)	SSTMDS-1296	64 (28)
15" (381)	36" (914)	SSTMS-1536	15 (7)	SSTMDS-1536	30 (14)
	48" (1219)	SSTMS-1548	20 (8)	SSTMDS-1548	40 (16)
	60" (1524)	SSTMS-1560	25 (11)	SSTMDS-1560	50 (22)
	72" (1829)	SSTMS-1572	30 (14)	SSTMDS-1572	60 (28)
	84" (2134)	SSTMS-1584	35 (16)	SSTMDS-1584	70 (32)
	96" (2438)	SSTMS-1596	40 (18)	SSTMDS-1596	80 (36)



Beverage Counters



SIZE IN (MM)	LxW IN (MM)	URN TROUGH LENGTH IN (MM)	MODEL	MODEL WITH GLASS RACK SLIDES	WGT. LBS (KG)
48" (1219)	48"x30" (1219x762)	18" (457)	STCT-3048-BC-L / R	STCT-GRS3048-BC-L / R	230 (104)
60" (1524)	60"x30" (1524x762)	24" (610)	STCT-3060-BC-L / R	STCT-GRS3060-BC-L / R	250 (113)
72" (1829)	72"x30" (1829x762)	36" (914)	STCT-3072-BC-L / R	STCT-GRS3072-BC-L / R	270 (122)
84" (2134)	84"x30" (2134x762)	36" (914)	STCT-3084-BC-L / R	STCT-GRS3084-BC-L / R	290 (131)
96" (2438)	96"x30" (2438x762)	36" (914)	STCT-3096-BC-L / R	STCT-GRS3096-BC-L / R	330 (149)

- Stainless steel top is 304 series 14 GA with 16 GA sides
- 10" High backsplash with a 2" return
- Sink is 14" x 16" x 12" D and is available on the Left (L) or Right (R) side
- 1½" basket drain
- Easy access panel to plumbing
- BC-GRS model standard with (3) rack slides for 20"x20" racks, 8" on centers
- No drip marine edge on 3 sides, Urn Trough
- 96" or longer units have 6 legs
- GFI Duplex outlet mounted in backsplash
- **Custom Sizes Available**

Dish Cabinet



LENGTH IN (MM)	MODEL 15" DEEP	MODEL 18" DEEP	WGT. LBS (KG)
48" (1219)	STCT-1548-DC	STCT-1848-DC	115 (52)
60" (1524)	STCT-1560-DC	STCT-1860-DC	130 (59)
72" (1829)	STCT-1572-DC	STCT-1872-DC	150 (68)
84" (2134)	STCT-1584-DC	STCT-1884-DC	175 (79)
96" (2438)	STCT-1596-DC	STCT-1896-DC	210 (95)

- Stainless steel top is 304 series 14 GA with 16 GA sides
- Fixed mid shelf starts at 20" Height with 12" spacing
- 35" Height with adjustable feet
- 96" or longer units have 6 leg
- **Custom Sizes Available**



OPTION: WB18 18" WALL BRACKETS

All Freight Class: 150



No backplash



1 1/2" backplash

Filler Tables

- All welded 16 GA 304 series stainless steel construction
- All TIG welded and shipped set up. High polish finish.
- 35" Height with adjustable stainless steel bullet feet
- Legs and cross bracing are 1 5/8" diameter 16 gauge stainless steel tubing
- Stainless steel hat channels deaden sound and reinforce the top to maintain a level work surface

WIDTH IN (MM)	LENGTH IN (MM)	NO BACKSPLASH	1 1/2" BACKSPLASH	WGT LBS (KG)
24" (610)	12" (305)	DTS-2412	DTSB-15-2412	22(10)
	15" (381)	DTS-2415	DTSB-15-2415	31 (14)
	18" (457)	DTS-2418	DTSB-15-2418	39 (18)
30" (762)	12" (305)	DTS-3012	DTSB-15-3012	25 (52)
	15" (381)	DTS-3015	DTSB-15-3015	33 (55)
	18" (457)	DTS-3018	DTSB-15-3018	41 (59)
36" (914)	12" (305)	DTS-3612	DTSB-15-3612	27 (57)
	15" (381)	DTS-3615	DTSB-15-3615	35 (61)
	18" (457)	DTS-3618	DTSB-15-3618	43 (66)

Equipment Stands

- Stainless steel top is 304 series 14 GA with 16 GA undershelf
- Work height is 24" high
- Rear and endsplash turned up 2"
- 96" or longer units have 6 legs



WIDTH IN (MM)	LENGTH IN (MM)	DC SERIES 14 GA	WGT LBS(KG)
24" 610)	24" (610)	ES/2424/14GA	45 (20)
	36" (914)	ES/2436/14GA	60 (27)
	48" (1219)	ES/2448/14GA	77 (35)
	60" (1524)	ES/2460/14GA	86 (38)
	72" (1829)	ES/2472/14GA	104 (47)
	84" (2134)	ES/2484/14GA	112 (50)
	96" (2438)	ES/2496/14GA	137 (62)
30" (762)	24" (610)	ES/3024/14GA	51 (23)
	36" (914)	ES/3036/14GA	68 (31)
	48" (1219)	ES/3048/14GA	85 (38)
	60" (1524)	ES/3060/14GA	102 (46)
	72" (1829)	ES/3072/14GA	119 (54)
	84" (2134)	ES/3084/14GA	142 (64)
	96" (2438)	ES/3096/14GA	164 (74)

OPTIONS:
 For 16 Gauge top and undershelf remove the /14GA from the model numbers above
 /M2LC 4 legs, 2 with locking casters
 /M6LC 6 legs, 3 with locking casters



All Freight Class: 150

Equipment Stand - Machine

- Ideal 24" x 28" top for mixer or grinder
- Convenient 28" height with adjustable stainless steel feet
- Lower shelf for attachment or storage supplies
- All welded 16 gauge stainless steel construction
- Shipped set up
- 1000 lbs (454 kg) weight capacity.

MODEL	WIDTH IN (MM)	LENGTH IN (MM)	HEIGHT IN (MM)	WGT LBS (KG)
ES/S2428	24" (610)	28" (711)	28" (711)	55 (25)





Mixer / Slicer Stand

- Stainless steel top is 304 Series 14 GA with 16 GA undershelf
- 24" High with adjustable feet
- 12" between shelf and table top
- No drip marine edge

WIDTH IN (MM)	LENGTH IN (MM)	DC SERIES 14 GA	WGT LBS (KG)
24" (610)	24" (610)	ES/MX2424/14GA	50 (23)
	30" (762)	ES/MX2430/14GA	60 (27)
30" (762)	30" (762)	ES/MX3030/14GA	65 (29)
	36" (914)	ES/MX3036/14GA	75 (34)
36" (914)	36" (914)	ES/MX3636/14GA	83 (37)

OPTION:

/M4LC 4 legs, 4 with locking casters

Freight Class: 150

Mixer / Slicer Stand with Utensil Tree

- Utensil tree allows convient hanging of tools

WIDTH IN (MM)	LENGTH IN (MM)	DC SERIES 14 GA	WGT LBS (KG)
24" (610)	24" (610)	ES/MX2424/UT/14GA	50 (23)
	30" (762)	ES/MX2430/UT/14GA	60 (27)
30" (762)	30" (762)	ES/MX3030/UT/14GA	65 (29)
	36" (914)	ES/MX3036/UT/14GA	75 (34)
36" (914)	36" (914)	ES/MX3636/UT/14GA	83 (37)

OPTION:

/M4LC 4 legs, 4 with locking casters

Freight Class: 150

Equipment Stand - Convection Oven

- Designed to fit most convection ovens
- Convenient right hand pan slides
- Maneuvers easily on 5" polyurethane casters two with brakes
- All welded 16 gauge stainless steel construction
- Shipped set up and ready to use

MODEL	WIDTH IN (MM)	LENGTH IN (MM)	HEIGHT IN (MM)	WGT LBS (KG)
ES/CO3048M	30" (762)	48" (1219)	29" (736)	175 (79)

Freight Class: 125

Equipment Stand - Scale

- Ideal for scales in produce and bulk food departments
- Convenient 38" height with adjustable stainless steel feet
- Two lower shelves for storage. Top 16" x 22" surface area
- 13" between Shelves
- Shipped set up and ready to use

MODEL	WIDTH IN (MM)	LENGTH IN (MM)	HEIGHT IN (MM)	WGT LBS (KG)
ES/S1622	22" (559)	16" (406)	38" (965)	64 (29)

Freight Class: 125

ES/MX2424/14GA

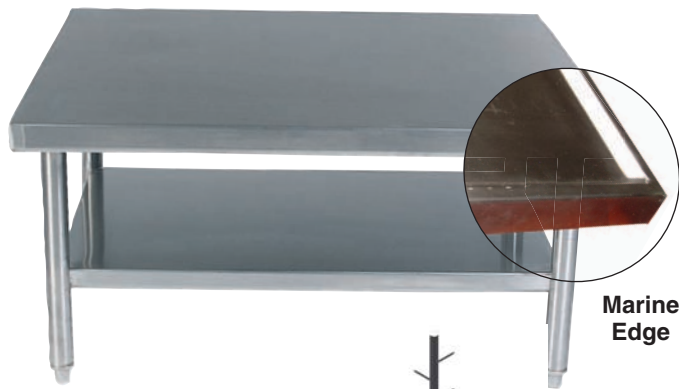

Marine Edge

ES/MX2424/UT/14GA/MRLC

Mixer Table above with Utensil Tree and (4) locking casters



ES/CO3048M



ES/S1622



Fabricated Wall Mounted Stainless Steel Shelves



- All welded 16 gauge stainless steel
- Available in 10", 12" and 15"
- Shelves come with 2 - 4 wall brackets depending on the length
- **Custom Sizes Available**

LENGTH IN (MM)	# of Hooks	10" WIDE (254mm)	WGT LBS (KG)	12" WIDE (305mm)	WGT LBS (KG)	15" WIDE (381mm)	WGT LBS (KG)
24" (610)	2	SSWMS102	10 (5)	SSWMS122	12 (5)	SSWMS152	14 (6)
36" (914)	3	SSWMS103	12 (5)	SSWMS123	15 (6)	SSWMS153	18 (9)
48" (1219)	4	SSWMS104	14 (6)	SSWMS124	18 (9)	SSWMS154	22 (10)
60" (1524)	4	SSWMS105	17 (8)	SSWMS125	24 (11)	SSWMS155	29 (13)
72" (1829)	6	SSWMS106	19 (9)	SSWMS126	25 (12)	SSWMS156	31 (14)
84" (2134)	6	SSWMS107	22 (10)	SSWMS127	29 (13)	SSWMS157	36 (16)
96" (2438)	8	SSWMS108	26 (12)	SSWMS128	34 (15)	SSWMS158	42 (19)

Fabricated Wall Mounted Stainless Steel Shelves with Pot Hooks

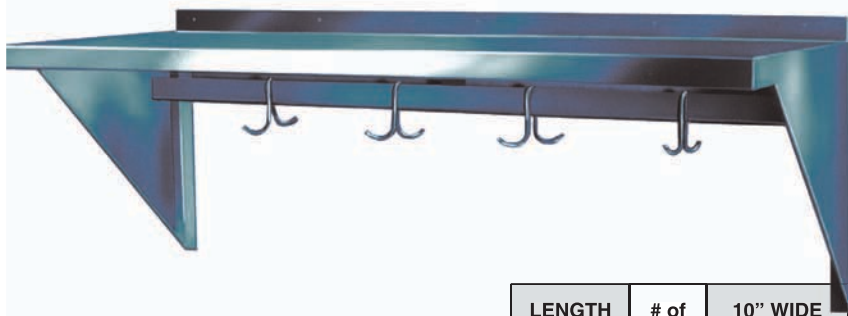

- All welded 16 gauge stainless steel
- Available in 10", 12" and 15"
- Shelves come with 2 - 4 wall brackets depending on the length
- Pot hooks come standard
- **Custom Sizes Available**

LENGTH IN (MM)	# of Hooks	10" WIDE (254mm)	WGT LBS (KG)	12" WIDE (305mm)	WGT LBS (KG)	15" WIDE (381mm)	WGT LBS (KG)
24" (610)	2	SSWMSH102	10 (5)	SSWMSH122	12 (5)	SSWMSH152	14 (6)
36" (914)	3	SSWMSH103	12 (5)	SSWMSH123	15 (6)	SSWMSH153	18 (9)
48" (1219)	4	SSWMSH104	14 (6)	SSWMSH124	18 (9)	SSWMSH154	22 (10)
60" (1524)	4	SSWMSH105	17 (8)	SSWMSH125	24 (11)	SSWMSH155	29 (13)
72" (1829)	6	SSWMSH106	19 (9)	SSWMSH126	25 (12)	SSWMSH156	31 (14)
84" (2134)	6	SSWMSH07	22 (10)	SSWMSH127	29 (13)	SSWMSH157	36 (16)
96" (2438)	8	SSWMSH108	26 (12)	SSWMSH128	34 (15)	SSWMSH158	42 (19)

Option: Extra Hooks (4994)

Knock Down Wall Shelves Stainless Steel

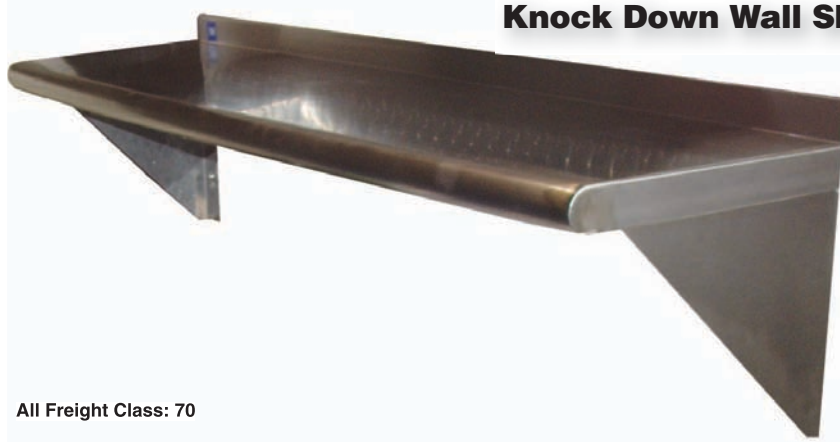

- Add extra storage where ever a wall exists
- 18 GA stainless steel wall shelf
- ****Wall Anchors determine the weight capacity of a wall shelf**

LENGTH IN (MM)	12" WIDE (305mm)	WGT LBS(KG)
24" (610)	SSWMS122/KD	10 (5)
36" (914)	SSWMS123/KD	12 (5)
48" (1219)	SSWMS124/KD	14 (6)
60" (1524)	SSWMS125/KD	17 (8)

All Freight Class: 70

Single Pass-Thru Shelves

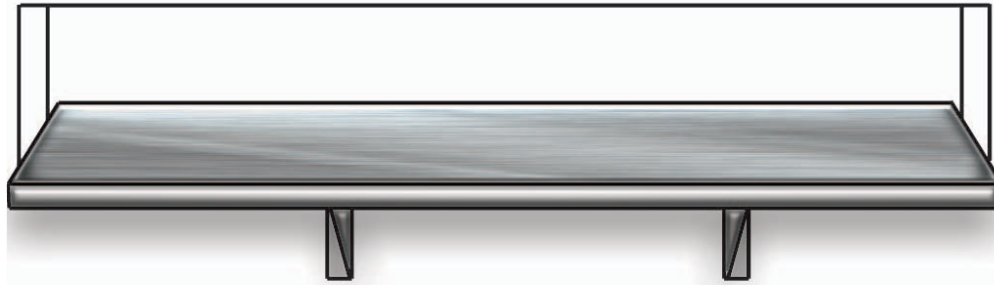

WIDTH IN (MM)	LENGTH IN (MM)	MODEL	# BRACKETS	WGT LBS (KG)
18" (457)	48" (1219)	SSPT-1848	2	14 (6)
	60" (1524)	SSPT-1860	2	17 (8)
	72" (1829)	SSPT-1872	2	19 (9)
	84" (2134)	SSPT-1884	3	22 (10)
	96" (2438)	SSPT-1896	3	26 (12)
24" (610)	48" (1219)	SSPT-2448	2	20 (9)
	60" (1524)	SSPT-2460	2	23 (11)
	72" (1829)	SSPT-2472	2	25 (11)
	84" (2134)	SSPT-2484	3	28 (13)
	96" (2438)	SSPT-2496	3	31 (14)

- Stainless steel shelf is 304 series 16 GA undershelf
- Two widths available 18" and 24" in various lengths
- 18" wide shelves have 2" x 4" "L" brackets
- 24" wide shelves have 5" x 5" cantilever brackets
- Custom Sizes Available

Freight Class: 150

Microwave Wall Shelves

- Stainless steel - 16 Gauge 304 series
- Back is 12" high with pre drilled holes for wall mounting

DEPTH IN (MM)	LENGTH IN (MM)	MODEL	WGT LBS (KG)
18" (457)	24" (600)	SSMS-1824	15 (7)
24" (600)	24" (600)	SSMS-2424	20 (9)

Freight Class: 70

Ceiling Mount Pot Racks Stainless Steel

- Stainless steel - 16 Gauge 304 series with pot hooks.

OPTIONS:

Extra Pot Hooks (4994)

LENGTH IN (MM)	MODEL	# POT HOOKS	WGT LBS (KG)
36" (914)	SSCMPR-3016	18	23 (10)
48" (1219)	SSCMPR-4816	18	26 (12)
60" (1524)	SSCMPR-6016	18	29 (13)
72" (1829)	SSCMPR-7216	18	32 (14)
84" (2134)	SSCMPR-8416	18	36 (16)
96" (2438)	SSCMPR-9616	18	44 (20)

Freight Class: 70



Wall Mount Pot Racks - Stainless Steel

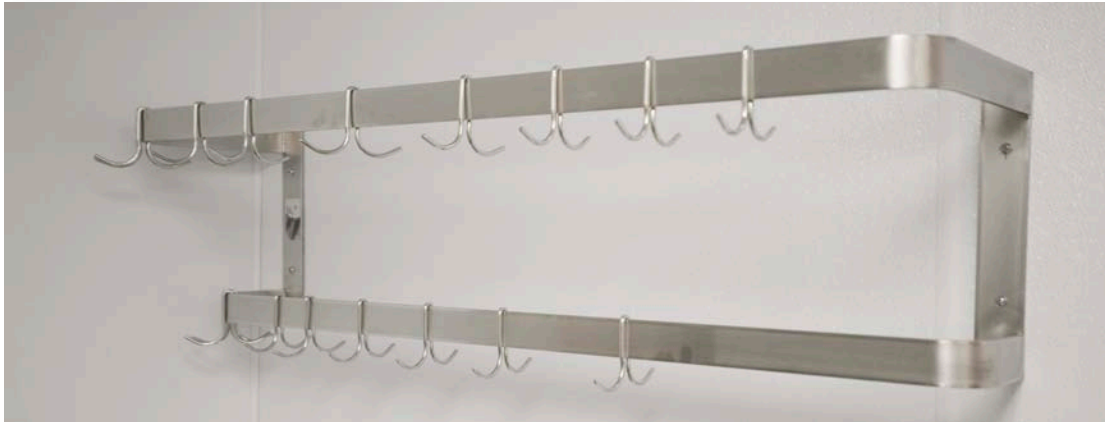

- All welded 16 gauge stainless steel
- Single and Double racks available
- Includes pot hooks
- **Custom Sizes Available**

OPTIONS:

Extra Pot Hooks (4994)

LENGTH IN (MM)	SINGLE RACK	# POT HOOKS	WGT LBS (KG)	DOUBLE RACK	# POT HOOKS	WGT LBS (KG)
36" (914)	SSWMPR-3016-S	6	4 (2)	SSWMPR-3016-D	12	23 (10)
48" (1219)	SSWMPR-4816-S	9	6 (3)	SSWMPR-4816-D	18	26 (12)
60" (1524)	SSWMPR-6016-S	9	7 (3)	SSWMPR-6016-D	18	29 (13)
72" (1829)	SSWMPR-7216-S	9	8 (4)	SSWMPR-7216-D	18	32 (14)
84" (2134)	SSWMPR-8416-S	9	9 (4)	SSWMPR-8416-D	18	36 (16)
96" (2438)	SSWMPR-9616-S	9	11 (5)	SSWMPR-9616-D	18	44 (20)
108" (2438)	SSWMPR-10816-S	9	13 (6)	SSWMPR-10816-D	18	48 (22)
120" (2438)	SSWMPR-12016-S	9	15 (6)	SSWMPR-12016-D	18	51 (24)
132" (2438)	SSWMPR-13216-S	9	16 (7)	SSWMPR-13216-D	18	55 (27)
144" (2438)	SSWMPR-14416-S	9	18 (7)	SSWMPR-14416-D	18	58 (29)

Wall Mount Cabinets



- All welded 16 gauge stainless steel
- Fixed Mid-Shelf
- 33" High
- Hinged Doors
- Optional lock available

Freight Class: 85



STCT-3615-WMS
Sliding Doors



STCT-3615-WMH
Hinged Doors

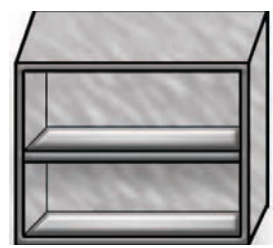

STCT-3615-WMO
Open Doors

WIDTH IN (MM)	DEPTH IN (MM)	OPEN NO DOORS	SLIDING DOORS	HINGE DOORS	WGT LBS (KG)
36" (914)	15" (381)	STCT-3615-WMO	-----	STCT-D3615-WMH	115 (52)
48" (1219)	15" (381)	STCT-4815-WMO	STCT-D4815-WMS	STCT-D4815-WMH	135 (61)
60" (1524)	15" (381)	STCT-6015-WMO	STCT-D6015-WMS	STCT-D6015-WMH	155 (70)

Freight Class: 150

RACKS



- Knock-Down Pan Racks
- Medium Duty Pan Racks
- Heavy Duty Pan Racks
- Extra Heavy Duty Pan Racks
- Half Size Pan Racks
- Universal Pan Racks
- Roll-In Refrigerator Pan Racks
- Reach-In Refrigerator Pan Racks
- Channel Pan Racks
- Wire Pan Racks
- Pizza Pan Racks
- Donut Screen Rack
- Nesting Racks
- Steam Table Racks
- Stainless Steel Pan Racks
- Can Racks
- Oven Racks
- French Fry Racks
- Cooling Racks



ADE1820B/KDA

Economy Knock-Down Pan Racks

- Material: Aluminum, all welded 1" Tubing. Runner angle 1" x 1-1/2"
- **Lifetime Warranty Against Rust**
- Application: Proof, store and transport full size sheet pans or half size sheet pans. When price is your 1st priority. Ships knock-down.
- Holds:
 - 18" x 26" Sheet Pans
 - 14" x 18" Sheet Pans
- Casters: 5" Polyolefin Swivel Stem
- Rolling Capacity: 600 lbs.
- Weight Capacity Per Runner: 20 lbs

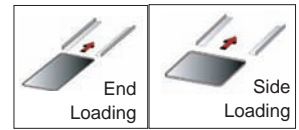

Model Number	Order#	Overall Dimensions						Pan Cap. 18"x26" 14"x18"	Runner Spacing		Approx. Ship Wt.	
		Width		Length		Height			(in)	(mm)	(lb)	(kg)
		(in)	(mm)	(in)	(mm)	(in)	(mm)					
ADE1820B/KDA	112168	21	533	26	660	69	1,753	20 40	3	76	30	14
ADE1812B/KDA	127440	21	533	26	660	69	1,753	12 24	5	127	28	13

Caster information:
Caster with 5" Polyolefin Wheel 751 (123588)
5" Polyolefin Wheel 717 (122681)
Freight Class: 175



Heavy Duty Knock-Down Pan Racks

- Material: Aluminum, all welded. Runner 1" x 1-1/2"
- **Lifetime Warranty Against Rust**
- Application: Proof, store and transport full size sheet pans or half size sheet pans. Heavier duty, ships knock-down.
- Holds:
 - 18" x 26" Sheet Pans
 - 14" x 18" Sheet Pans
- Casters: 5" Polyurethane Swivel Stem
- Rolling Capacity: 800 lbs.
- Weight Capacity Per Runner: 30 lbs

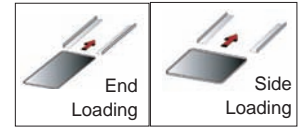

Model Number	Order#	Overall Dimensions						Pan Cap. 18"x26" 14"x18"	Runner Spacing		Approx. Ship Wt.	
		Width		Length		Height			(in)	(mm)	(lb)	(kg)
		(in)	(mm)	(in)	(mm)	(in)	(mm)					
AL-1820BKD/HD	323459	21	533	26	660	69	1,753	20 40	3	76	34	19
Half Height												
AL-1810/HKD	209357	21	533	26	660	38	955	10 20	3	76	23	10

Caster information:
Caster with 5" Polyurethane Wheel 757 (123684)
5" Polyurethane Wheel 7112 (122180)
Freight Class: 250

Option: Specify options by adding suffix to Model Numbers

XB XHD Reinforced Upright

AL-1820BKD/HD



AL-1810/HKD



Items highlighted in red are Express Ship!

See page 148 for details.

In line with our policy to continually improve our products, Winholt reserves the right to change materials and specifications without notice.

Medium Duty Pan Racks - End Load

- Material: Aluminum, all welded. Runner angle 1"x1-1/2"
- **Lifetime Warranty Against Rust**
- Application: Proof, store and transport finished product holds full size sheet pans or half size sheet pans.

- Holds: 18" x 26" Sheet Pans
14" x 18" Sheet Pans
- Casters: 5" Polyurethane Swivel Stem
- Rolling Capacity: 800 lbs.
- Weight Capacity Per Runner: 30 lbs
- **Options at bottom of page.**

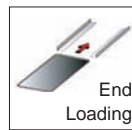

Model Number	Order#	Overall Dimensions						Pan Cap. 18"x26" 14"x18"	Runner Spacing		Approx. Ship Wt.	
		Width		Length		Height			(in)	(mm)	(lb)	(kg)
		(in)	(mm)	(in)	(mm)	(in)	(mm)					
AL-1810B	109840	21	533	26	660	69¾	1,772	10 20	6	152	22	10
AL-1812B	109882	21	533	26	660	69¾	1,772	12 24	5	127	25	11
AL-1815B	109938	21	533	26	660	69¾	1,772	15 30	4	102	28	13
AL-1818B	109989	21	533	26	660	69¾	1,772	18 36	3	76	32	15
AL-1820B	110023	21	533	26	660	69¾	1,772	20 40	3	76	30	14
AL-1830B	110120	21	533	26	660	69¾	1,772	30 60	2	51	44	19

Caster information:
Caster with 5" Polyurethane Wheel 757 (123684)
5" Polyurethane Wheel 7112 (122180)
Freight Class: 250

Items highlighted in red are Express Ship!
See page 148 for details.



Medium Duty Pan Racks - Side Load

- Material: Aluminum, all welded. Runner angle 1" x 1-1/2"
- **Life time Warranty Against Rust**
- Application: Proof, store and transport finished product holds full size sheet pans, loading on the 26" side.

- Holds: 18" x 26" Sheet Pans
- Casters: 5" Polyurethane Swivel Stem
- Rolling Capacity: 800 lbs.
- Weight Capacity Per Runner: 30 lbs



Model Number	Order#	Overall Dimensions						Pan Cap. 18"x26"	Runner Spacing		Approx. Ship Wt.	
		Width		Length		Height			(in)	(mm)	(lb)	(kg)
		(in)	(mm)	(in)	(mm)	(in)	(mm)					
AL-2610B	110251	28	711	18	457	69¾	1,772	10	6	152	18	8
AL-2612B	110269	28	711	18	457	69¾	1,772	12	5	127	21	7
AL-2615B	110293	28	711	18	457	69¾	1,772	15	4	102	23	8
AL-2618B	110322	28	711	18	457	69¾	1,772	18	3	76	24	8
AL-2620B	110349	28	711	18	457	69¾	1,772	20	3	76	26	8

Caster information:
Caster with 5" Polyurethane Wheel 757 (123684)
5" Polyurethane Wheel 7112 (122180)
Freight Class: 250

Heavy Duty Polyurethane Casters



Options for Racks on this page:

Specify options by adding suffix to Model Numbers

- | | |
|---|-----------------------------------|
| B Bumpers (4) | KD Knock-Down Design |
| BP Plate Casters 5" Polyurethane Wheel | SB Aluminum Solid Bottom |
| LC Locking Casters | CORR Correctional Package |
| TG-AL Tray Guard/Aluminum | XB XHD Reinforced Uprights |





AL-1820B/XB

Heavy Duty Pan Rack - End Load

- Material: Aluminum, all welded 1" tubing. Runner angle 1"x1-1/2"
- **Lifetime Warranty Against Rust**
- Application: Heavy duty rack proof, store and transport full size sheet pans or half size sheet pans. Ideal for schools, restaurants, catering, banquet halls.
- Holds:
 - 18" x 26" Sheet Pans
 - 14" x 18" Sheet Pans
- Casters: 5" Polyurethane Swivel Stem
- Rolling Capacity: 800 lbs.
- Weight Capacity Per Runner: 60 lbs

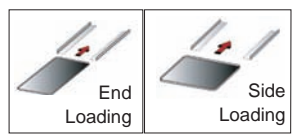

Model Number	Order#	Overall Dimensions						Pan Cap.	Runner Spacing		Approx. Ship Wt.	
		Width		Length		Height			(in)	(mm)	(lb)	(kg)
		(in)	(mm)	(in)	(mm)	(in)	(mm)	18"x26"				
AL-1820B/XB	647023	21	533	26	660	69¾	1772	20	3	76	34	15

Caster information:
 Caster with 5" Polyurethane Wheel 757 (123684)
 5" Polyurethane Wheel 7112 (122180)
Freight Class: 250



- Options: Specify options by adding suffix to Model Numbers**
- B** Bumpers (4)
 - BP** Plate Casters 5" Polyurethane Wheel
 - LC** Locking Casters
 - TG-AL** Tray Guard/Aluminum
 - KD** Knock-Down Design
 - SB** Aluminum Solid Bottom
 - CORR** Correctional Package



AL-1820/HD

XTRA Heavy Duty Pan Rack - End Load

- Material: Aluminum, all welded 1 1/2" tubing. Runner angle 1-1/4"x 2"
- **Lifetime Construction Warranty**
Lifetime Warranty Against Rust
Excludes Casters & Fasteners
- Application: Heavy duty rack for use in correctionals, catering, schools and commissaries.
- Holds:
 - 18" x 26" Sheet Pans
 - 4" x 18" Sheet Pans
- Tubing 1½"
- Casters: 5 x 2" Polyurethane Swivel Plate (2) with locks
- Rolling Capacity: 1000 lbs.
- Weight Capacity Per Runner: 80 lbs

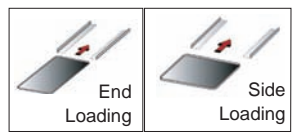

Model Number	Order#	Pan Cap. 18" x 26" 14" x 18"	Dimensions						Runner Spacing		Approx. Ship Wt.	
			Width		Length		Height		(in)	(mm)	(lb)	(kg)
			(in)	(mm)	(in)	(mm)	(in)	(mm)				
AL-1812/HD	592536	12 24	21½	546	26	660	71½	1,816	5	127	54	25
AL-1820/HD	592165	20 40	21½	546	26	660	71½	1,816	3	76	70	32
AL-1830/HD	592173	30 60	21½	546	26	660	71½	1,816	2	51	86	39

Caster information:
 Caster with 5"x2" Polyurethane Wheel 7318 (123051)
Freight Class: 250



- Options: Specify options by adding suffix to Model Numbers**
- ST** Solid Top
 - SB** Solid Base
 - PEB** Perimeter Bumper
 - LB** "L" shape Bumper
 - VB** Vertical Bumper (12")
 - PP** Prison Package

In line with our policy to continually improve our products, Winholt reserves the right to change materials and specifications without notice.

Half Size Pan Racks - Side Load

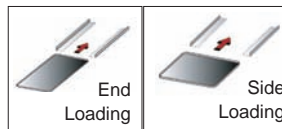

- Material: Aluminum, all welded 1" tubing. Runner angle 1"x1-1/2"
- **Lifetime Warranty Against Rust**
- Application: Designed for low volume locations that do not need a full size rack. Work top available in aluminum, stainless steel or poly top.

- Holds: 18" x 26" Sheet Pans, 14" x 18" Sheet Pans
- Casters: 5" Polyurethane Swivel Stem
- Rolling Capacity: 800 lbs.
- Weight Capacity Per Runner: 30 lbs

Model Number	Order#	Overall Dimensions						Pan Cap. 18"x26" 14"x18"	Runner Spacing		Approx. Ship Wt.	
		Width		Length		Height			(in)	(mm)	(lb)	(kg)
		(in)	(mm)	(in)	(mm)	(in)	(mm)					
Open Top												
AL-1806/H	206797	21	533	26	660	38	955	6 12	5	127	21	10
AL-1810/H	206800	21	533	26	660	38	955	10 20	3	76	23	10
Aluminum Top												
AL-1806H/ALTOP	—	21	533	26	660	38	955	6 12	5	127	21	10
AL-1810H/ALTOP	625941	21	533	26	660	38	955	10 20	3	76	23	10
Stainless Steel Top												
AL-1806H/SSTOP		21	533	26	660	38	955	6 12	5	127	21	10
AL-1810H/SSTOP	537676	21	533	26	660	38	955	10 20	3	76	31	14
Poly Top												
AL-1810/H-PT	567488	21	533	26	660	38	955	10 20	3	76	31	14

Caster information:

Caster with 5" Polyurethane Wheel 757 (123684)

5" Polyurethane Wheel 7112 (122180)

Freight Class: 250

Options: Specify options by adding suffix to Model Numbers

B	Bumpers (4)	SB	Aluminum Solid Bottom
BP	Plate Casters 4" Polyurethane Wheel	CORR	Correctional Package
LC	Locking Casters	XB	XHD Reinforced Upright
TG-AL	Tray Guard/Aluminum		
KD	Knock-Down Design		



AL-1810/H



AL-1810H/ALTOP



Medium Duty Universal Runner Rack

- Material: Aluminum, all welded. Runner angle 1-1/4" x 3-1/3"
- **Lifetime Warranty Against Rust**
- Application: Medium duty universal pan rack for holding steam table pans and sheet pans.

- Holds: 18" x 26" Sheet Pans, 14" x 18" Sheet Pans, Full, Half, 1/3 Size Steam Pans (held by the lip)
- Casters: 5" Polyurethane Swivel Stem
- Rolling Capacity: 800 lbs.
- Weight Capacity Per Runner: 30 lbs

Model Number	Order#	Overall Dimensions						Pan Cap. 18"x26" 14"x18"	Runner Spacing		Approx. Ship Weight	
		Width		Length		Height			(in)	(mm)	(lb)	(kg)
		(in)	(mm)	(in)	(mm)	(in)	(mm)					
UARE-1218	389212	21	533	26	660	69	1,753	12 24	5	127	35	16
UARE-2018	389221	21	533	26	660	69	1,753	20 40	3	76	72	33

Caster information:

Caster with 5" Polyurethane Wheel 757 (123684)

5" Polyolefin Wheel 717 (122681)

Freight Class: 250

Option: Specify options by adding suffix to Model Numbers

XB	XHD Reinforced Upright
-----------	------------------------



UARE-2018





ALUN-1820/HD

XTRA Heavy Duty Universal Runner Rack

- Material: High tensile extruded 6063-T5 aluminum alloy. All heli-arc welded aluminum construction, tubing: 1-1/2", Runner angles: 1-1/4" x 3-1/4"
- Holds:
 - 18" x 26" Sheet Pans
 - 14" x 18" Sheet Pans
 - Full, Half, 1/3 Size Steam Pans (held by the lip)
- Casters: 5 x 2" Polyurethane Plate
- Rolling Capacity: 800 lbs.
- Weight Capacity Per Runner: 80 lbs
- **Lifetime Construction Warranty**
Lifetime Warranty Against Rust
Excludes Casters & Fasteners
- Application: For holding steam table pans and sheet pans.

Model Number	Order#	Pan Cap. 18"x26"	Pan Cap. 12"x20"	Pan Cap. 14"x18"	Dimensions						Runner Spacing		Approx. Ship Wt.	
					Width		Length		Height		(in)	(mm)	(lb)	(kg)
					(in)	(mm)	(in)	(mm)	(in)	(mm)				
ALUN-1812/HD	592552	12	11	24	21½	546	26	660	71½	1,816	5	127	74	34
ALUN-1820/HD	592544	20	19	40	21½	546	26	660	71½	1,816	3	76	92	42

Caster information:
Caster with 5"x2" Polyurethane Wheel 7318 (123051)
Freight Class: 250



Options: Specify options by adding suffix to Model Numbers

- ST Solid Top
- SB Solid Base
- PEB Perimeter Bumper
- LB "L" shape Bumper
- VB Vertical Bumper (12")
- PP Prison Package

Heavy Duty Polyurethane Casters



UAR-1023

Medium Duty Universal Wide Runner Racks

- Material: All welded aluminum 1-1/4" tubing, runner angles: 1-1/4" x 6-1/8"
- Holds:
 - 18" x 26" Sheet Pans
 - 14" x 18" Sheet Pans
 - Full, Half, 1/3 Size Steam Pans (held by the bottom)"
- Casters: 5 x 2" Polyurethane Plate
- Rolling Capacity: 800 lbs.
- Weight Capacity Per Runner: 60 lbs
- **Lifetime Warranty Against Rust**
- Application: Economy rack for holding steam table pans and sheet pans.

Model Number	Order#	Overall Dimensions						Pan Cap. All Sizes	Runner Spacing		Approx. Ship Weight	
		Width		Length		Height			(in)	(mm)	(lb)	(kg)
		(in)	(mm)	(in)	(mm)	(in)	(mm)					
UAR-1023	389124	26	660	27	686	70	1778	10	6	152	70	32
UAR-1223	389141	26	660	27	686	70	1778	12	5	127	78	36
UAR-2023	389167	26	660	27	686	70	1778	20	3	76	110	50

Caster information:
Caster with 5" Polyurethane Wheel 757 (123684)
5" Polyurethane Wheel 7112 (122180)
Freight Class: 250



Option: Specify options by adding suffix to Model Numbers

- XB XHD Reinforced Upright

Roll-In Refrigerator Racks

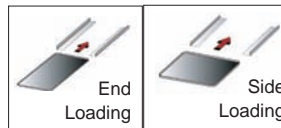

- Material: All welded aluminum 1" tubing, Runner angle 1-1/4"
- Lifetime Warranty Against Rust
- Application: Designed for roll-in refrigerators and freezers.
- Holds:
 - 18" x 26" Sheet Pans
 - 14" x 18" Sheet Pans
- Casters: 5 Polyurethane Swivel Stem
- Rolling Capacity: 800lbs.
- Weight Capacity Per Runner: 30 lbs

Model Number	Order#	Overall Dimensions						Pan Cap. 18"x26" 14"x18"	Runner Spacing		Approx. Ship Weight	
		Width		Length		Height			(in)	(mm)	(lb)	(kg)
		(in)	(mm)	(in)	(mm)	(in)	(mm)					
ALREF-1118/64E	384956	20 ^{7/8}	530	26	660	64 ^{1/4}	1,632	11 22	5	127	40	18
ALREF-1818/64E	384981	20 ^{7/8}	530	26	660	64 ^{1/4}	1,632	18 36	3	76	53	24

Caster information:
 Caster with 5" Polyurethane Wheel 757 (123684)
 5" Polyurethane Wheel 7112 (122180)
Freight Class: 250



Option: Specify options by adding suffix to Model Numbers

XB XHD Reinforced Upright

Knock Down Reach-In Refrigerator Insert Racks

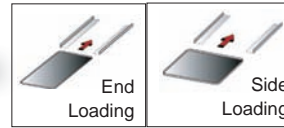

- Material: All welded aluminum 1-1/2" tubing, Runner angle 1"x 1-1/4"
- Lifetime Warranty Against Rust
- Application: To hold sheet pans inside reach-in refrigerators and freezers.
- Holds:
 - 18" x 26" Sheet Pans
 - 14" x 18" Sheet Pans
- Weight Capacity Per Runner: 30 lbs



AL-1807-IR-KD

Model Number	Order#	Overall Dimensions						Pan Cap. 18"x26" 14"x18"	Runner Spacing		Approx. Ship Wt.	
		Width		Length		Height			(in)	(mm)	(lb)	(kg)
		(in)	(mm)	(in)	(mm)	(in)	(mm)					
AL-1807-IR-KD	626089	20 3/8	518	24	610	23	584	7 14	3	76	14	6
AL-1816-IR-KD	582928	20 3/8	518	24	610	51	1295	16 32	3	76	28	13

Items highlighted in red are Express Ship!
 See page 148 for details.



In line with our policy to continually improve our products, Winholt reserves the right to change materials and specifications without notice.

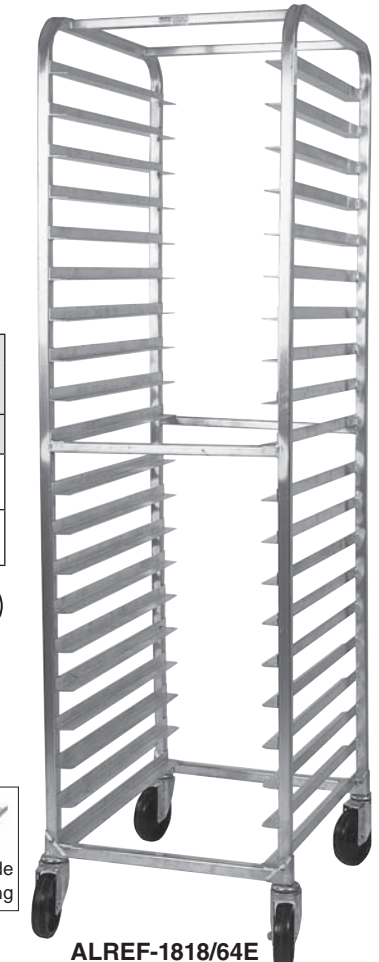

ALREF-1818/64E



AL-1816-IR-KD



ALC-1836

Channel Pan Racks

- Material: All welded aluminum, C-Channel is 1-1/2" x 1 with a lip of 5/8"
- Rolling Capacity: 800lbs.
- Weight Capacity Per Runner: **30lbs**
- **Lifetime Warranty Against Rust**
Application: Designed for maximum storage capacity in bakeries, restaurants, industrial areas where high and low profile products are stored.
- Holds:
18" x 26" Sheet Pans by lip
14" x 18" Sheet Pans by lip
- Casters: 5" Polyurethane Swivel Stem

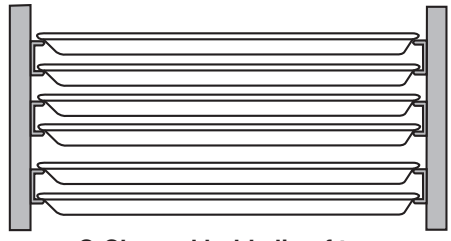

C-Channel holds lip of tray

Model Number	Order#	Overall Dimensions						Pan Cap. 18"x26" 14"x18"	Runner Spacing		Approx. Ship Wt	
		Width		Length		Height			(in)	(mm)	(lb)	(kg)
		(in)	(mm)	(in)	(mm)	(in)	(mm)					
ALC-1836	110648	21	533	27	686	64	1,626	36 72	3	76	40	18
ALC-1840	110672	21	533	27	686	64	1,626	40 80	1½	38	42	19

Caster information:
Caster with 5" Polyurethane Wheel 757 (123684)
5" Polyurethane Wheel 7112 (122180)
Freight Class: 250



Option: Specify options by adding suffix to Model Numbers
XB XHD Reinforced Upright

Wire Pan Rack



WP-1836B

- Material: Aluminum Frame 1" tubing with Chrome Steel Wire Slides, runner spacing 1-1/2"
- Application: Ideal for cooling, transporting, storing and proofing. Half size racks double as mobile work stations.
- Holds:
18" x 26" Sheet Pans by lip
14" x 18" Sheet Pans by lip
- Casters: 5" Polyurethane Swivel Stem
- Rolling Capacity: 800lbs.
- Weight Capacity Per Runner: **30lbs**



WP-1830D/PT
Polytop Workstation



WP-1815D/PPT
Polytop Workstation

Model Number	Order#	Overall Dimensions						Pan Cap. 18"x26" 14"x18"	Approx. Ship Wt	
		Width		Length		Height			(lb)	(kg)
		(in)	(mm)	(in)	(mm)	(in)	(mm)			
WP-1836B	111034	21	533	24	610	68	1,727	36 72	67	30
WP-1815 / PPT	110947	21	533	25	635	32	813	15 30	47	21
WP-1830D / PT	110998	46	1,168	25	635	32	813	30 60	74	34

Caster information:
Caster with 5" Polyurethane Wheel 757 (123684)
5" Polyurethane Wheel 7112 (122180)
Freight Class: 250

Pizza Pan Racks

- Material: All welded aluminum 1" tubing, Runner angle 1-1/4" x 6-1/8"
- **Lifetime Warranty Against Rust**
- Application: Designed for pizza restaurants.
- Holds: 12", 14", & 16" Round Pans
17" x 19" Round Pans
6" x 17" Sicilian Pans
- Casters: 5" Polyurethane Swivel Stem, two with locking casters
- Rolling Capacity: 800 lbs.
- Weight Capacity Per Runner: **30 lbs**



PPR-13

Model Number	Order#	Overall Dimensions						# of Pans	Runner Spacing		Approx. Ship Wt	
		Width		Length		Height			(in)	(mm)	(lb)	(kg)
		(in)	(mm)	(in)	(mm)	(in)	(mm)					
PPR-13	206818	22	559	20	508	34	864	13	2	51	38	17
PPR-26	206826	22	559	20	508	62½	1,588	26	2	51	53	24

Caster information:

Swivel Square Stem Caster w/ 5" Polyurethane Wheel & Brake 757ABK (206931)

Swivel Square Stem Caster with 5" Polyurethane Wheel 757 (123684)

5" Polyurethane Wheel 7112 (122180)

Freight Class: 250

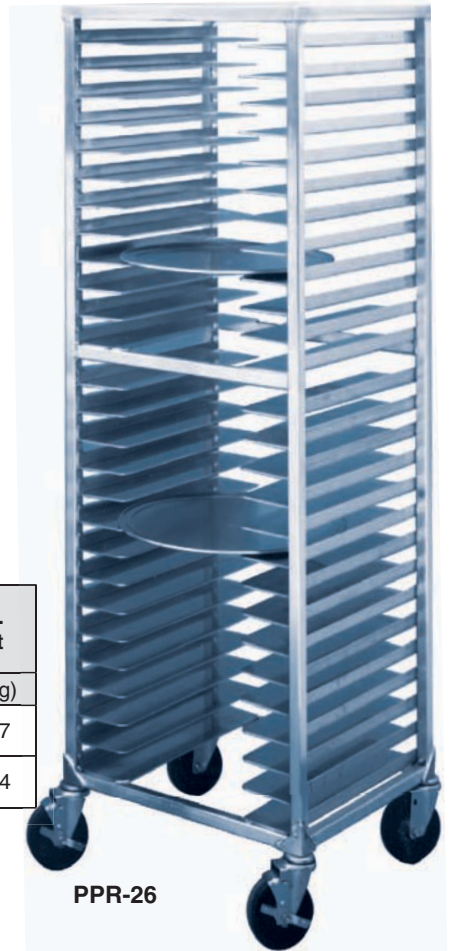

PPR-26

Donut Screen Racks

- Material: All welded aluminum 1" tubing, Runner angle on AL-2424B - 1" x 1-1/2" AL-2420/33D - 1" x 2"
- **Lifetime Warranty Against Rust**
- Application: Ideal for proofing and transporting donuts.
- Holds: 23" x 23" Donut Screens
24" x 24" Glazing Screens
AL-2420/33D also holds 24" x 33"
- Casters: 5" Polyurethane Swivel Stem
- Rolling Capacity: 800lbs.
- Weight Capacity Per Runner: **30lbs**

Model Number	Order#	Overall Dimensions						Pan Cap.	Runner Spacing		Approx. Ship Wt	
		Width		Length		Height			(in)	(mm)	(lb)	(kg)
		(in)	(mm)	(in)	(mm)	(in)	(mm)					
AL-2420/33D	667489	24 9/32	642	33	838	69	1,753	20	3	76	46	21
AL-2424B	110226	27	686	24	610	70	1,772	20	3	76	43	19

Caster information:

Swivel Square Stem Caster with 5" Polyurethane Wheel 757 (123684)

5" Polyurethane Wheel 7112 (122180)

Freight Class: 250



AL-2424B

Option: Specify options by adding suffix to Model Numbers

XB XHD Reinforced Upright

In line with our policy to continually improve our products, Winholt reserves the right to change materials and specifications without notice.



AL-1820N

Medium Duty Nesting Pan Racks

- Material: Available in all welded aluminum or stainless steel, 1" tubing. Runner angles 1"x1-1/2"
- **Lifetime Warranty Against Rust**
- Application: Pan Rack for storage & proofing. Racks nest to save freight, floor space and labor
- 6 "Z" racks will take up 15 sq/ft vs. 6 standard racks take up 22.5 sq/ft
- Holds:
 - 18" x 26" Sheet Pans
 - 14" x 18" Sheet Pans
 - Casters: 5" Polyurethane Swivel Stem
 - Rolling Capacity: **800 lbs.**
 - Weight Capacity Per Runner: **30 lbs**

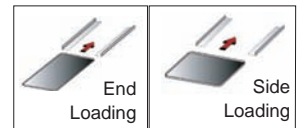

Model Number	Order#	Overall Dimensions						Pan Cap. 18"x26"	Runner Spacing		Approx. Ship Wt	
		Width		Length		Height			(in)	(mm)	(lb)	(kg)
		(in)	(mm)	(in)	(mm)	(in)	(mm)					
Aluminum												
AL-1810N	267371	21	533	26	660	70	1,778	10	6	152	35	16
AL-1820N	110066	21	533	26	660	70	1,778	20	3	76	48	22
Stainless Steel												
SS-1810N	289140	21	533	26	660	70	1,778	10	6	152	80	36
SS-1820N	289158	21	533	26	660	70	1,778	20	3	76	110	50

Caster information:
Caster with 5" Polyurethane Wheel 757 (123684)
5" Polyurethane Wheel 7112 (122180)
Freight Class: 250

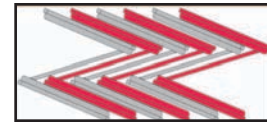

Medium Duty Steam Pan Racks

- Material: Available in all welded aluminum (AL) or stainless steel (SS), Runner angles 1"x1-1/2"
- **Lifetime Warranty Against Rust**
- Application: Ideal for volume production of food stored in steam table pans - Casinos, Hospitals, Restaurants.
- Holds:
 - 12" x 20" steam table pans, by lip
 - Full, half & third size pans by lip
 - Casters: 5" Polyurethane Swivel Stem
 - Rolling Capacity: **800 lbs**
 - Weight Capacity Per Runner: **30 lbs**

Model Number	Order#	Overall Dimensions						Box Cap.	Runner Spacing		Approx. Ship Wt	
		Width		Length		Height			(in)	(mm)	(lb)	(kg)
		(in)	(mm)	(in)	(mm)	(in)	(mm)					
Loads on the 20" Side(Side Loads) - Holds 2 Full Size Pans Per Ledge												
ALSPR-2212	382387	23 ^{7/8}	606	27 ^{3/8}	69	68 ^{1/2}	1,740	12	5	127	30	14
ALSPR-2220	382395	23 ^{7/8}	606	27 ^{3/8}	695	68 ^{1/2}	1,740	20	3	76	42	19
Loads on the 12" Side (End Loads) - Holds 1 Full Size Pans Per Ledge												
ALSPR-1320	157788	13 ^{7/8}	352	22 ^{3/8}	568	68 ^{1/2}	1,740	20	3	76	55	25
SSPR-1320	382408	13 ^{7/8}	352	22 ^{3/8}	568	68 ^{1/2}	1,740	20	3	76	81	37
Double Wide, Loads on the 12" Side (End Loads) - Holds 1 Pan Per Ledge												
ALSPRD-1320	382424	30 ^{3/4}	781	22 ^{3/8}	568	68 ^{1/2}	1,740	40	3	76	81	37

Caster information:
Caster with 5" Polyurethane Wheel 757 (123684)
5" Polyurethane Wheel 7112 (122180)
Freight Class: 250



Option: Specify options by adding suffix to Model Numbers
XB XHD Reinforced Upright



ALSP-1320



Medium Duty Pan Racks Stainless Steel End Load

- Material: stainless steel construction, 1" tubing, Runner angles 1" x 1-1/2"
- **Lifetime Warranty Against Rust**
- Application: For proofing, storage and transporting finished product on 18" x 26" and 14" x 18" pans and trays.
- Holds:
End Load holds (1) 18" x 26" full sheet pans
Side Load holds (2) 18" x 14" half sheet pans
- Rolls easily on heavy duty 5" polyurethane swivel stem casters
- Rolling Capacity: **800 lbs**
- Weight Capacity per Runner: **30 lbs**

Model Number	Order#	Overall Dimensions						Pan Cap. 18"x26"	Runner Spacing		Approx. Ship Wt	
		Width		Length		Height			(in)	(mm)	(lb)	(kg)
		(in)	(mm)	(in)	(mm)	(in)	(mm)					
SS-1810B	110470	21	533	26	660	69¾	1,772	10	6	152	42	19
SS-1812B	110488	21	533	26	660	69¾	1,772	12	5	127	51	23
SS-1818B	110525	21	533	26	660	69¾	1,772	18	3	76	65	29
SS-1820B	110541	21	533	26	660	69¾	1,772	20	3	76	70	32
SS-1830B	110568	21	533	26	660	69¾	1,772	30	2	51	90	41

Caster information:

Caster with 5" Polyurethane Wheel 757 (123684)

5" Polyurethane Wheel 7112 (122180)

Freight Class: 250

Options: Specify options by adding suffix to Model Numbers

- | | |
|---|----------------------------------|
| B Bumpers (4) | KD Knock-Down Design |
| BP Plate Casters 5" Polyurethane Wheel | CORR Correctional Package |
| LC Locking Casters | XB XHD Reinforced Upright |
| TG-SS Tray Guard/Stainless Steel | |



SS-1820B



Heavy Duty Polyurethane Casters

Medium Duty Pan Racks Stainless Steel Side Load

- Material: stainless steel construction, 1" tubing, Runner angles 1" x 1-1/2"
- **Lifetime Warranty Against Rust**
- Application: For proofing, storage and transporting finished product on 18" x 26" pans, side loading.
- Holds:
Side Load holds (2) 18" x 26" half sheet pans
- Rolls easily on heavy duty 5" polyurethane swivel stem casters
- Rolling Capacity: **800 lbs**
- Weight Capacity per Runner: **30 lbs**

Model Number	Order#	Overall Dimensions						Pan Cap. 18"x26"	Runner Spacing		Approx. Ship Wt	
		Width		Length		Height			(in)	(mm)	(lb)	(kg)
		(in)	(mm)	(in)	(mm)	(in)	(mm)					
SS-2610B	110584	28	711	18	457	69¾	1,772	10	6	152	76	34
SS-2618B	156339	28	711	18	457	69¾	1,772	18	3	76	38	39
SS-2620B	110605	28	711	18	457	69¾	1,772	20	3	76	97	44

Caster information:

Caster with 5" Polyurethane Wheel 757 (123684)

5" Polyurethane Wheel 7112 (122180)

Freight Class: 250

Option: Specify options by adding suffix to Model Numbers

- XB** XHD Reinforced Upright



SS-2610B



CR-162

Can Dispensing Racks Full Size

- Material: all welded aluminum, Vertical uprights and cross braces are constructed of 1½" aluminum tubing.
- **Lifetime Warranty Against Rust**
- Application: Organizes can stock and maximizes available space. Self-feeding feature keeps stock rotated.
- Mobile units are easily maneuvered on two 5" locking swivel and two 5" rigid polyurethane plate casters.



Heavy Duty Polyurethane Plate Caster 738A



CR-162M

Model Number	Order #	Type of Unit	Overall Dimensions						Can Capacity		Approx. Ship Wt	
			Width		Length		Height		#10	#5	(lb)	(kg)
			(in)	(mm)	(in)	(mm)	(in)	(mm)				
CR-162	112491	Stationary	25¼	641	35	889	71	1,803	162	216	60	27
CR-162AJ	112504	Adjustable	25¼	641	35	889	71	1,803	162	216	60	27
CR-162M	112512	Mobile Station	27½	699	35	889	76	1,930	162	216	66	30

Option for CR-162M:

Specify options by adding suffix to

Model Number

CORR Correctional Package

Caster Information

Swivel Plate Caster with 5" Polyurethane Wheel 738A (128784)

Rigid Plate Caster with 5" Polyurethane Wheel 743A (128792)

5" Polyurethane Wheel 7112 (122180)

Freight Class: 250



Items highlighted in red are Express Ship. See Page 148 for details.

Mobile Can Dispensing Racks, Half Size

- Material: Vertical uprights and cross braces are constructed of 1½" aluminum tubing.
- **Lifetime Warranty Against Rust**
- Application: Organizes can stock and maximizes available space. Self-feeding feature keeps stock rotated.
- Half size racks double as a workstation. Available with stainless steel, aluminum, or poly-top work surfaces.
- Mobile units are easily maneuvered on two 5" locking swivel and two 5" rigid polyurethane plate casters.



**CR-54PT
Polytop Workstation**



**Heavy
Duty
Polyurethane
Plate Caster
738A**

Model Number	Order#	Type of Top	Overall Dimensions						Can Capacity		Approx. Ship Wt	
			Width		Length		Height		#10	#5	(lb)	(kg)
			(in)	(mm)	(in)	(mm)	(in)	(mm)				
CR-54M	112521	Aluminum								50	23	
CR-54PT	112547	Poly Top	27½	699	35	889	35	889	54	72	65	29
CR-54S/S	112555	Stainless Steel								42	19	
CR-72M	112563	Aluminum								58	26	
CR-72PT	112571	Poly Top	27½	699	35	889	40	1,016	72	96	72	33
CR-72S/S	112580	Stainless Steel								62	28	

Caster Information

Swivel Plate Caster with 5" Polyurethane Wheel 738A (128784)
 Rigid Plate Caster with 5" Polyurethane Wheel 743A (128792)
 5" Polyurethane Wheel 7112 (122180)

Freight Class: 250



Can Dispensing Rack, Gravity Fed - FIFO

- Material: Made of all welded, high strength, extruded aluminum.
- **Lifetime Warranty Against Rust**
- Application: First In-First Out can rack automatically rotates your inventory. Organizes and maximizes your stockroom space.
- Replaces 14' of 18" x 4 tier wire shelving.
- Convenient front loading for easy stocking.
- Cans are visible and accessible for quick and easy inventory.
- Adjustable feet.

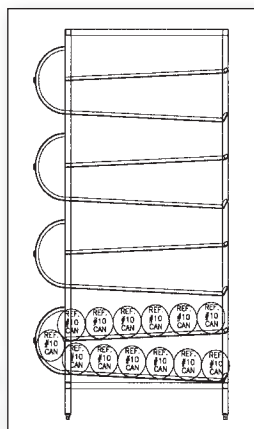

**Self Feeding Keeps
Inventory Rotated & Fresh!**



CR-156F

Model Number	Order#	Overall Dimensions						Can Capacity		Approx. Ship Wt	
		Width		Length		Height		#10	Runner Shelf	(lb)	(kg)
		(in)	(mm)	(in)	(mm)	(in)	(mm)				
CR-156F	229121	27	686	44	1,118	76	1,930	156	13	85	39

Freight Class: 250



In line with our policy to continually improve our products, Winholt reserves the right to change materials and specifications without notice.



Side Loading



End Loading

Oven Racks Aluminum & Stainless

Winholt Equipment Group offers a wide range of Oven Racks in all styles and sizes that are compatible to many leading oven manufacturers, they include:

- Revent
- Hobart/Adamatic
- Baxter
- Bakers Aid
- Lucks
- Gemini



Specifications:

- Constructed of all welded heavy duty stainless steel or aluminum.
- **Lifetime Warranty Against Rust**
- Angle pan slides will accommodate 18" x 26" or 20" x 30" bun pans, depending on the model to include: strapped bread pans, perforated screens, muffin pans and other pan types.
- Standard Runners are 1" x 1½" wide
- Available in End Load, Side Load and Double Side Load Models
- All racks are equipped with four 4" phenolic super high temperature wheels with zerk grease fittings for easier lubrication and longer life.
- Lifting devices are constructed of Stainless Steel, and are designed for optimum rotation for even heat distribution.
- Weight Capacity per Runner: **30 lbs**

Oven rack specifications may vary from oven to oven, so please call before ordering. We want to ensure a perfect fit!

- Allows easier & faster cleaning
- Fast replacement of wheels
- NSF approved
- Stainless & Aluminum Materials
- Use with any medium duty plate caster

Options Include:

- Tray Guards
- Special Slide Spacing
- Double Racks
- "B" & "D" Style Lifts
- Nesting Oven Racks
- Stainless Steel Plate Caster with Phenolic High Temp (B)



Suggested Lubricant for Casters:

Low Corning 44 High Temperature Bearing Grease

- Medium Consistency
- Resistant to Oxidation, Moisture and Corrosion
- Rated: -40 to 425°F
-40 to 204°C



In line with our policy to continually improve our products, Winholt reserves the right to change materials and specifications without notice.

Oven Racks

Winholt Equipment Group offers a wide range of Oven Racks in all styles and sizes that are compatible with many leading oven manufacturers.

Oven Rack specifications may vary from oven to oven, so please call for a quote on your oven specifications, to ensure a perfect fit!

Aluminum & Stainless Steel Casters available with Phenolic Super High Temp wheels



1" x 1½" width Runners
Custom Runners available

Space between Runners

Side Load, End Load and Double Side Load widths available

4" Phenolic High Temperature Wheels

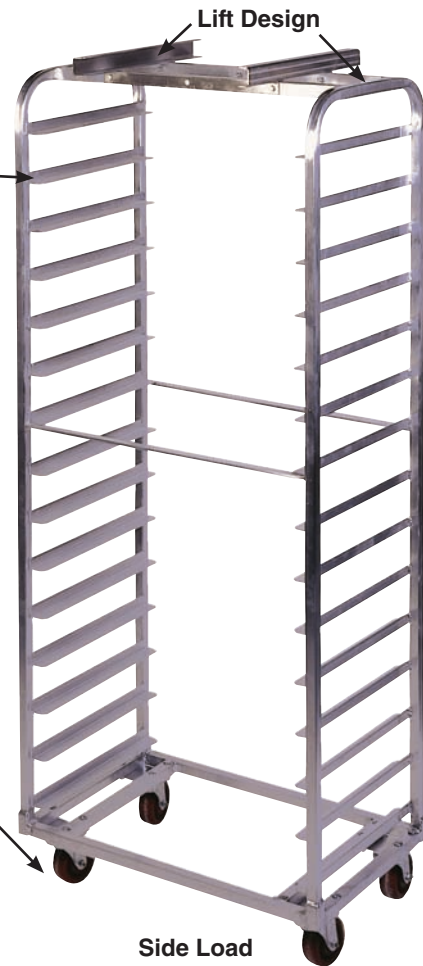

Tray Direction

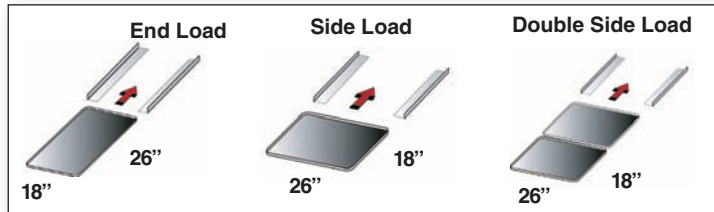

Side Load

Lift Type

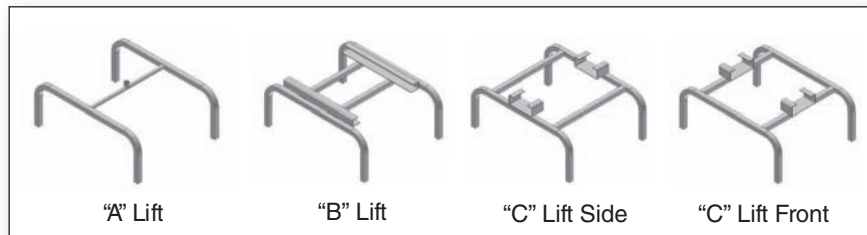

Phenolic Super High Temperature Wheels

TO ASSIST IN ORDERING, USE THE FOLLOWING CHART TO BUILD AN OVEN RACK:

BUILD AN OVEN RACK

A O V S 1 8 1 2 B X A D 1 2 T G

Material

A = Aluminum
S = Stainless

Item

OV = Oven Rack

Size

S = Single
D = Double

Tray Size Side/End Load

18 = Front
26 = Side
20 = Front
30 = Side

Number of Runners

08
10
12
15
18
20
30

Manufacturer

RV = Revent
XB = Baxter
BA = Bakers Aid
LU = Lucks
G1 = Gemini
G2 = Gemini
G3 = Gemini
G4 = Gemini
H = Hobart

Lifting Device

A = Top Nipple (RV)
B = 2 Channel (RV)
C = 4 Channel (RV)
D = Compact (RV)
AD1 = Advantage1 (BX)
AD2 = Advantage2 (BX)
NL = No Locator (BA)
LB = Locator Bracket (BA)
LC = Locator Channel (BA)
LW = Locator Wheel (BA)
PG = Pin Guide (BA)

Options

TG = Tray Guard
2TG = 2 Tray Guards
LT = Low Temp Wheels

**Call Winholt at
800-444-3595 for Design Assistance
and Pricing!**



FFR-18

French Fry Rack

- Material: Heavy duty, all welded aluminum construction resists rust and corrosion.
- **Lifetime Warranty Against Rust**
- Application: Perfect for fast-paced, busy operations. Ideally suited for both fried and frozen products in all stages of preparation.
- Supplied with removable, easy to clean, aluminum drip pan.
- Two handles facilitate maneuvering easily on four 5" polyurethane plate casters. Four corner bumpers protect fixtures.



**Baskets
Not Included**



**Heavy
Duty
Polyurethane
Plate Caster
738A**

Model Number	Order #	Overall Dimensions						Basket Capacity	Approx. Ship Wt	
		Width		Length		Height			(lb)	(kg)
		(in)	(mm)	(in)	(mm)	(in)	(mm)			
FFR-18	183513	18	457	27¼	692	52	1,333	18	20	9
FFR-27	183521	24¾	629	27¼	692	52	1,333	27	22	10

Caster information:

Caster with 5" Polyurethane Wheel 757 (123684)

5" Polyurethane Wheel 7112 (122180)

Freight Class: 250



MCR-6

Cooling Rack Mobile

- Material: The frame is constructed of all welded 1" aluminum square tubing with removable nickel chrome plated steel wire shelving for easy cleaning.
- Application: Ideal for cooling, storing, transporting and merchandising baked goods.
- Extremely durable and easy to maneuver on four 5" polyurethane swivel stem casters.
- 11" spacing between Shelves

Model Number	Order #	Overall Dimensions						Capacity		Approx. Ship Wt	
		Width		Length		Height		(lb)	(kg)	(lb)	(kg)
		(in)	(mm)	(in)	(mm)	(in)	(mm)				
MCR-6	126068	25	635	49	1,245	66¹³/₁₆	1,697	800	363	100	45

Caster information:

Caster with 5" Polyurethane Wheel 757 (123684)

5" Polyurethane Wheel 7112 (122180)

Freight Class: 250

In line with our policy to continually improve our products, Winholt reserves the right to change materials and specifications without notice.

HEATER PROOFERS & CABINETS



Non-Insulated Heater Proofers

Economy Standard

1/2 Height Under the Counter

Universal Runner

Insulated Heater Proofer

Enclosed Mobile Transport Cabinets



NHPL-1836-ECOC

Heater Proofers - Non-Insulated Economy
100% Pre-Tested Electrical Assembly

- Heavy Duty, aluminum construction designed for durability.
- Easy to Clean.
- Forced air design provides even heat distribution.
- 5" polyurethane plate casters for easy maneuverability and stability. Front casters are provided with brakes.
- Easy dual proof/heat control:
- "Proof/humidity" mode: Up to 95% humidity at 110°F (43°C)
- "Heat" mode: Maximum Temperatures up to 180°F (82°C)
- Clear door, extruded, anodized aluminum frame will not dull. A tight fit gasket is installed on the inside door frame.
- Door opens 270 degrees. Door lifts off for easy cleaning and accessibility.
- Control drawer is removable for quick and easy cleaning and maintenance.
- Drip trough catches condensation. Internal water pan collects condensation or is used in proofer mode.
- All controls are accessible without opening cabinet door. Easy to read real time LED thermometer display.
- Pan Capacity: 35 - 18" x 26" pans

Electrical specifications:

- 120 Volt-60 Hz, NEMA 5-15P
- 1440 Watts: 14.0 AMPS - Plug into any standard 110 outlet.

Model Number	Order#	Overall Dimensions						Approx. Ship Wt	
		Width		Length		Height		(lb)	(kg)
		(in)	(mm)	(in)	(mm)	(in)	(mm)		
NHPL-1836-ECOC	684668	21	533	30¾	781	66½	1,689	136	106

Heavy Duty Polyurethane Swivel Plate Caster 73819



Caster Information
 Swivel Plate Caster with 5" Polyurethane Wheel 738A (128784)
 Swivel Plate Caster with 5" Polyurethane Wheel & Brake 738ABK (204185)
 5" Polyurethane Wheel 7112 (122180)
Freight Class: 100



Items highlighted in red are Express Ship! See details on page 148.



Heater Proofers - Non-Insulated Standard Full & 1/2 Height 100% Pre-Tested Electrical Assembly

- Heavy Duty, aluminum construction designed for durability.
- Easy to Clean.
- Forced air design provide even heat distribution.
- 5" polyurethane plate casters for easy maneuverability and stability. Front casters are provided with brakes.
- Easy dual proof/heat control:
- "Proof/humidity" mode: Up to 95% humidity at 110°F (43°C)
- "Heat" mode: Maximum Temperatures up to 180°F (82°C)
- Corner bumpers provide protection to unit, associates & fixtures.
- Clear door, extruded, anodized aluminum frame will not dull. A tight fit gasket is installed on the inside door frame.
- Door opens 270 degrees. Door lifts off for easy cleaning and accessibility.
- Control drawer is removable for quick and easy cleaning and maintenance.
- Drip trough catches condensation. Internal water pan collects condensation or is used in proofer mode.
- All controls are accessible without opening cabinet door. Easy to read real time LED thermometer display.
- Pan Capacity: 35 - 18" x 26" pans NHPL-1836C
10 - 18" x 26" pans NHPL-1810HHC

Electrical specifications:

- 120 Volt-60 Hz, NEMA 5-15P
- 1440 Watts: 14.0 AMPS - Plug into any standard 110 outlet.

Model Number	Order#	Overall Dimensions						Approx. Ship Wt	
		Width		Length		Height		(lb)	(kg)
		(in)	(mm)	(in)	(mm)	(in)	(mm)		
NHPL-1836C	684684	21	533	30¾	781	66½	1,689	136	106
NHPL-1810HHC	684625	21	533	30¾	781	66½	1,689	91	41

Caster Information

Swivel Plate Caster with 5" Polyurethane Wheel 738A (128784)
Swivel Plate Caster with 5" Polyurethane Wheel & Brake 738ABK (204185)
5" Polyurethane Wheel 7112 (122180)

Freight Class: 100



Items highlighted in red are Express Ship!
See details on page 148

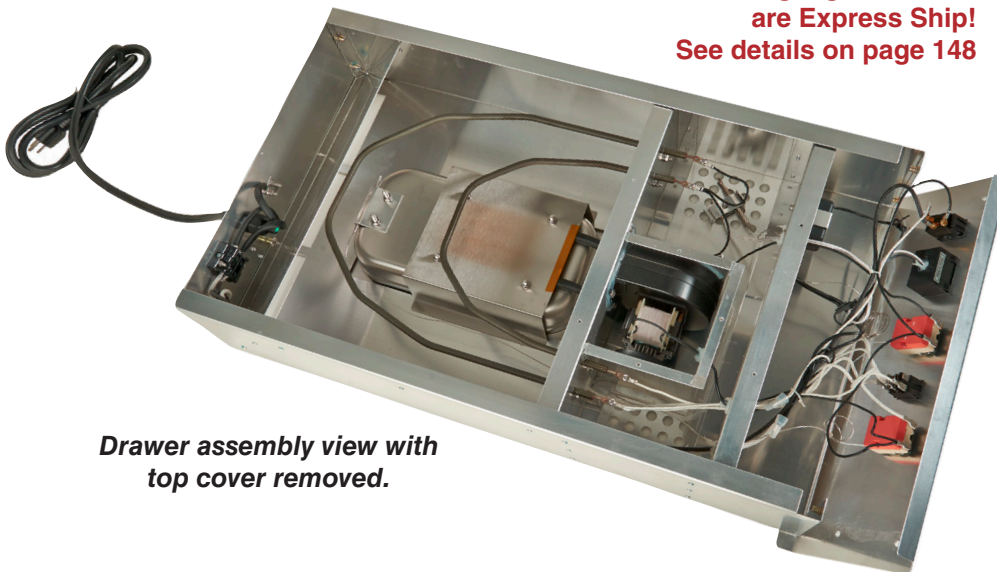

Drawer assembly view with top cover removed.



NHPL-1836C



NHPL-1810HHC
Fits under counters and tables.

For replacement parts please see page 143.



NHPL-1825-UNC

**Heater Proofers - Non-Insulated
Universal Runner
100% Pre-Tested Electrical Assembly**

- Non-insulated - Heavy duty aluminum construction.
- Forced air design provides even heat distribution.
- Removable chrome pan slides for variable spacing and for easy cleaning. Wire slided can be adjusted on 2" increments. Ships with 25 pan slide sets.
- 5" polyurethane plate casters for easy maneuverability and stability. Front casters are provided with brakes.
- Easy dual proof/heat control:
 - "Proof/humidity" mode: Up to 95% RH at 110°F (43°C)
 - "Heat" mode: Maximum Temperatures up to 180°F (82°C)
- Full length clear door opens 90 degrees.
- Field reversible door for right or left hanging is standard. Magnetic door latch for keeping door closed during transport. Easy pull handle for opening.
- Wire slided can be adjusted on 2" increments.
- Slides accommodate standard steam pans.
- Control drawer is removable for quick and easy cleaning and maintenance.
- Drip Trough catches condensation. Internal water pan collects condensation or is used in proofer mode.
- All controls are accessible without opening cabinet door. Easy to read real time LED thermometer display.
- Pan Capacity: 28 - 18" x 26" pans
- Corner bumpers provide protection to unit, associates and fixtures.

Electrical specifications:

- 120 Volt-60 Hz, NEMA 5-15P
- 1440 Watts: 14.0 AMPS - Plug into any standard 110 outlet.



**Adjustable Universal Runners
Holds a variety of pan configurations.**

Option: Additional runner slide (1)
NHPL-1825-UN-Runner
(657150)

Model Number	Order#	Overall Dimensions						Approx. Ship Wt	
		Width		Length		Height		(lb)	(kg)
		(in)	(mm)	(in)	(mm)	(in)	(mm)		
NHPL-1825-UNC	684641	24	610	32	813	70	1,778	235	106

Caster Information

- Swivel Plate Caster with 5" Polyurethane Wheel 738A (128784)
- Swivel Plate Caster with 5" Polyurethane Wheel & Brake 738ABK (204185)
- 5" Polyurethane Wheel 7112 (122180)

Freight Class: 100



Magnetic Door Latch



Field Reversible Door Mount

Heater Proofers - Insulated

35% Energy Savings!

100% Pre-Tested Electrical Assembly

- Heavy Duty, aluminum construction designed for durability.
- Easy to Clean.
- Forced air design provides even heat distribution.
- 5" polyurethane plate casters for easy maneuverability and stability. Front casters are provided with brakes.
- Easy dual proof/heat control:
- "Proof/humidity" mode: Up to 95% RH at 110°F (43°C)
- "Heat" mode: Maximum Temperatures up to 180°F (82°C)
- Corner bumpers provide protection to unit, associates & fixtures.
- Clear door, extruded, anodized aluminum frame will not dull. A tight fit gasket is installed on the inside door frame.
- Door opens 270 degrees. Door lifts off for easy cleaning and accessibility.
- Control drawer is removable for quick and easy cleaning and maintenance.
- Drip Trough catches condensation. Internal water pan collects condensation or is used in proofer mode.
- All controls are accessible without opening cabinet door. Easy to read real time LED thermometer display.
- Pan Capacity: 35 - 18" x 26" pans

Electrical specifications:

- 120 Volt-60 Hz, NEMA 5-15P
- 1440 Watts: 14.0 AMPS - Plug into any standard 110 outlet.

Model Number	Order#	Overall Dimensions						Approx. Ship Wt	
		Width		Length		Height		(lb)	(kg)
		(in)	(mm)	(in)	(mm)	(in)	(mm)		
INHPL-1836C	684609	21^{1/2}	546	32	813	66^{3/4}	1695	154	106

Caster Information

Swivel Plate Caster with 5" Polyurethane Wheel 738A (128784)
 Swivel Plate Caster with 5" Polyurethane Wheel & Brake 738ABK (204185)
 5" Polyurethane Wheel 7112 (122180)

Freight Class: 100



INHPL-1836

Items highlighted in red are Express Ship!
 See page 148 for details.



For replacement parts please see page 143.



EC1840-C

EC1810-LSLD
Modified Enclosed Cabinet makes a perfect display!

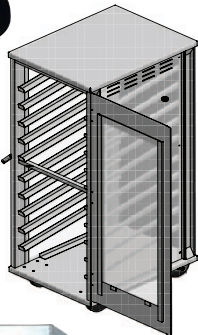

Enclosed Mobile Transport Cabinets

- Stores and transport goods—retards dehydration! All welded, reinforced, non-insulated aluminum. Sanitary and rustproof.
- Double pan construction with reinforced braces, 1½” spacing between runners.
- Easily maneuverable on four 5” Polyurethane, swivel plate, double ball race casters. Locking casters are available.

Model Number	Order#	Overall Dimensions						Pan Cap. 18" x 26"	Approx. Ship Wt	
		Width		Length		Height			(lb)	(kg)
		(in)	(mm)	(in)	(mm)	(in)	(mm)			
EC1816-C	110795	21	533	27	686	32	813	16	57	26
EC1824-C	110824					44	1,118	24	70	32
EC1832-C	110832					56	1,422	32	84	38
EC1840-C	110841					68	1,727	40	94	43
With Clear Acrylic Door										
EC1840-C / LD	150375	21	533	27	686	68	1,727	40	115	52
Ezee View Display - Clear Acrylic Door & Sides, Slanted Runners & Vented Sides										
EC1810-LSLD	651680	21	533	27 ^{3/8}	705	68 ^{1/4}	1,734	10	94	43

Caster Information

Swivel Plate Caster with 5” Polyurethane Wheel 738A (128784)

5” Polyurethane Wheel 7112 (122180)

Freight Class:150



Option: Specify options by adding suffix to Model Number
CORR Correctional Package

Items highlighted in red are Express Ship!
See page 148 for details.

Enclosed Mobile Transport Cabinets Heavy Duty



- Stores and transport goods—retards dehydration!
- Constructed of all welded, reinforced, non-insulated aluminum. Sanitary and rustproof.
- Double pan top construction with reinforced brace, 1½” spacing between runners.
- Heavy duty, reinforced hinges and latch assure easy closing with a secure fit.
- Maneuvers easily on 5” polyurethane, swivel plate, double ball race casters.

Model Number	Order#	Overall Dimensions						Pan Cap 18"x26"	Approx. Ship Wt	
		Width		Length		Height			(lb)	(kg)
		(in)	(mm)	(in)	(mm)	(in)	(mm)			
Heavy Duty Enclosed Cabinet with Reinforced Undercarriage										
EC1840-CTL	110859	21	533	27	686	68	1,727	40	115	52
Extra Heavy Duty Enclosed Cabinet with Reinforced Undercarriage and Frame										
EC1832-CTLPURC	150383	21	533	27	686	56	1,422	32	115	52
EC1840-CTLPURC	110904					68	1,727	40	120	54

Caster Information

Swivel Plate Caster with 5” Polyurethane Wheel 7318 (123051)

5” Polyurethane Wheel 7128 (122438)

Freight Class:150

Option: Specify options by adding suffix to Model Number
CORR Correctional Package /6PU 6” Polyurethane Casters

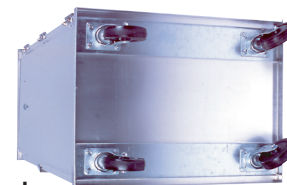

Heavy Duty, reinforced, galvanized steel undercarriage, provides extra strength support.



EC-1840-CTLPURC





TRANSPORT & MOBILE STORAGE



Queen Mary
Stainless Steel Utility Carts
Ingredient Bins
Sheet Pan Trucks
Dollies
Plastic Utility Carts
Linen Transport
Garment Rack

Heavy Duty Queen Mary Banquet Carts Aluminum & Stainless Steel



- Multipurpose cart designed for storage and transportation of pots, pans, wire baskets, cups, and dishes.
- Aluminum: The frame is constructed of all welded 1½" x 1½" x 3/16" all welded reinforced aluminum. The shelves are constructed of heavy duty reinforced aluminum sheet.
- Stainless Steel: The frame is constructed of all welded 1½" x 1½" x 3/16" all welded reinforced stainless steel. The shelves are constructed of heavy duty reinforced stainless steel sheet.
- **Life time Warranty Against Rust**
- Standard configuration is 3 lips flanged up and front lip down. Other configurations are available upon request.
- A wrap around bumper protects walls, associates and equipment. Welded handle for easy maneuverability.
- Maneuvers on two 8" x 2" rigid and two 8" x 2" swivel polyurethane wheels with double race casters.



Heavy duty 8" Polyurethane Mold-on Wheels

Model Number	Order#	Overall Dimensions						# of Shelves	Shelf Spacing		Approx. Ship Weight	
		Width		Length		Height			(in)	(mm)	(lb)	(kg)
		(in)	(mm)	(in)	(mm)	(in)	(mm)					
Aluminum Queen Mary												
BNQT-3	154325	28	711	60	1,524	65 ⁷ / ₁₆	1,662	3	27	686	140	64
BNQT-4	127546	28	711	60	1,524	65 ⁷ / ₁₆	1,662	4	17 ¹⁹ / ₃₂	447	160	73
BNQT-5	112598	28	711	60	1,524	65 ⁷ / ₁₆	1,662	5	13½	343	180	82
Stainless Steel Queen Mary												
BNQT-3S/S	232012	28	711	60	1,524	65 ⁷ / ₁₆	1,662	3	27	686	295	134
BNQT-4S/S	168997	28	711	60	1,524	65 ⁷ / ₁₆	1,662	4	17 ¹⁹ / ₃₂	447	340	154
BNQT-5S/S	232021	28	711	60	1,524	65 ⁷ / ₁₆	1,662	5	13½	343	385	174

Caster information:
 Swivel Plate Caster with 8" Polyurethane Mold-on Wheel 73161 (123035)
 Rigid Plate Caster with 8" Polyurethane Mold-on Wheel 7471 (123537)
 8" Polyurethane Mold-on Wheel 7116 (122294)
Freight Class: 250



Economy Utility Carts Stainless Steel

- Economy Stainless Steel Utility cart, great cart for healthcare, schools, hotels, and correctional use.
- 16 Gauge shelves and tubing standard, with rounded handle
- **Life time Warranty Against Rust**
- Load Capacity of 1200 lbs
- Capacity per shelf 400 lbs
- Distance between shelves 12", 3 shelves 48" L x 24" W, lip height 1 1/2"
- 5" polyurethane plate casters, (2) rigid, (2) swivel.



Model #	Order#	Overall Dimensions						Shelf Size (in)	Approx. Ship Wt	
		Width		Length		Height			(lb)	(kg)
		(in)	(mm)	(in)	(mm)	(in)	(mm)			
SSUC-3-2453/35H	999475	24	406	54	1372	35	1219	48Lx 24W	115	52

Freight Class: 250

Medium Duty Utility Carts Stainless Steel

- For transporting items and products, used in schools, laboratories, hospitals, facilities management, material handling and restaurants.
- All welded stainless steel construction TIG welded.
- **Life time Warranty Against Rust**
- Units have a rolling capacity of 800 lbs.
- (2) shelf carts have 27" between shelves, (3) Shelf carts have 13" between shelves
- Manuevers easily on 5" polyurethane plate swivel stem casters



Heavy Duty Polyurethane Wheels with sealed precision bearing



Model #	Order#	Overall Dimensions						# & Shelf Size (in)	Approx. Ship Wt	
		Width		Length		Height			(lb)	(kg)
		(in)	(mm)	(in)	(mm)	(in)	(mm)			
Single Handle Utility Cart										
SSUC-2-1832/1H/45H	684561	18	457	37 ^{1/6}	941	44 ^{1/2}	1130	(2)18 x 32	40	18
SSUC-3-1832/1H/45H	684553	18	457	37 ^{1/6}	941	44 ^{1/2}	1130	(3)18 x 32	53	24
SSUC-2-2133/1H/45H	687009	21	553	38 ^{1/6}	969	44 ^{1/2}	1130	(2)21 x 33	55	25
SSUC-3-2133/1H/45H	686997	21	553	38 ^{1/6}	969	44 ^{1/2}	1130	(3)21 x 33	71	32
Double Handle Utility Cart										
SSUC-2-1832/2H/45H	684596	18	457	37 ^{1/6}	941	44 ^{1/2}	1130	(2)18 x 32	46	21
SSUC-3-1832/2H/45H	684596	18	457	37 ^{1/6}	941	44 ^{1/2}	1130	(3)18 x 32	55	25
SSUC-2-2133/2H/45H	684588	21	553	38 ^{1/6}	969	44 ^{1/2}	1130	(2)21 x 33	59	27
SSUC-3-2133/2H/45H	684570	21	553	38 ^{1/6}	969	44 ^{1/2}	1130	(3)21 x 33	75	34



Caster information:
 Caster with 5" Polyurethane Wheel 757W (523071)
 Caster with 5" Polyurethane Wheel & Brake 757BKW (526408)
 5" Polyurethane Wheel 7112 (122180)
Freight Class: 250

Heavy Duty Utility Carts Stainless Steel



- Great cart for healthcare, schools, hotels, and correctional use.
- 16 Gauge shelves and tubing standard.
- **Life time Warranty Against Rust**
- Units have a rolling capacity of 2800 lbs.
- 14 Gauge unit and custom size available upon request.
- Casters: Standard with 5" x 2" polyurethane plate casters at no additional charge.



Heavy Duty Reinforced Construction



Caster information:
 Swivel Plate Caster with 5" Polyurethane Wheel 7321CBZ (123086)
 Rigid Plate Caster with 5" Polyurethane Wheel 7451(123473)
 5" Polyurethane Mold-on Wheel 7023 (191038)
Freight Class: 250

Options:
 Specify options by adding suffix to Model Numbers
CORR Correctional Package

Model #	Order#	Overall Dimensions						Shelf Size (in)	Approx. Ship Wt	
		Width		Length		Height			(lb)	(kg)
		(in)	(mm)	(in)	(mm)	(in)	(mm)			
2 Shelves - 23-1/2" Shelf Spacing										
UC-2-1832SS	627065	18	457	38	965	37½	953	18 x 32	70	32
UC-2-2133SS	627081	21	533	39	991	37½	953	21 x 33	77	35
UC-2-2149SS	627111	21	533	55	1397	37½	953	21 x 49	92	42
3 Shelves - 11" Shelf Spacing										
UC-3-1832SS	627073	18	457	38	965	37½	953	18 x 32	84	38
UC-3-2133SS	627090	21	533	39	991	37½	953	21 x 33	93	42
UC-3-2149SS	627102	21	533	55	1397	37½	953	21 x 49	115	52



Ingredient Bin Single Stainless Steel

- Stainless Steel frame with one-piece, seamless, NSF and FDA approved polyethylene liner.
- Rugged construction for lifetime durability. Winholt ingredient bins won't bulge or break.
- Durable single-piece transporting handle with nameplate holder.
- Fingertip slide-off cover completely removable.
- 3" diameter casters two swivel two rigid for complete mobility even when fully loaded. Casters are securely affixed to rugged metal base not molded into plastic where they can break away.
- Airtight design for better product protection and sanitation.
- Lift out poly-liner for maximum working convenience.
- Perfect for under bench applications

Total Capacity
 ● 150 lb Flour (68 kg)
 ● 218 lb Sugar (99 kg)



Caster Information
 4" Polyurethane Rigid Plate Caster 7418 (123369)
 4" Polyurethane Swivel Plate Caster 7351 (123211)
 4" Polyurethane Wheel 7125 (122403)
Freight Class: 150

Model Number	Order#	Overall Dimensions						Approx. Ship Wt	
		Width		Length		Height		(lb)	(kg)
		(in)	(mm)	(in)	(mm)	(in)	(mm)		
IB-S216W / P16NF	270810	15	381	27	686	28	711	40	18
4FM0359P	899634	Replacement Poly-Liner							

Ingredient Bins, Single Plastic

- Holds large quantities of ingredients at a time.
- Durable smooth structural plastic.
- Rounded corners for easy cleaning.
- Fits conveniently under counter tops.
- Clear plastic lid prevents cross-contamination.
- 3" Smooth rolling non-marking casters.

Total Capacity

- 21 Gallons



Model Number	Order#	Overall Dimensions						Approx. Ship Wt	
		Width		Length		Height			
		(in)	(mm)	(in)	(mm)	(in)	(mm)	(lb)	(kg)
IB-1329/28H/21GAL	999723	13	330	29	737	28	711	23	10

Freight Class: 150



Ingredient Bins, Triple

- Heavy duty plastic bins are constructed of seamless, one-piece, sanitary polyethylene. Will not chip, corrode or rust.
- Bins are available in White, Yellow and Blue, to color code for easy product identification with clear plastic covers. Aluminum covers also available.
- Ideal height, conveniently fits under work tables, saving valuable space.
- Heavy duty frame. Bins and lids are interchangeable with other brands.
- The frame is constructed of sanitary aluminum that will not rust and maneuvers easily on large 5" polyurethane casters.

Total Capacity per Bin

- 55 lb Flour (25 kg)
- 75 lb Sugar (34 kg)

Model Number	Order#	Overall Dimensions						Approx. Ship Wt	
		Width		Length		Height			
		(in)	(mm)	(in)	(mm)	(in)	(mm)	(lb)	(kg)
Aluminum Assembly with 1 White, 1 Yellow, and 1 Blue Tub and (3) Three Clear Covers									
148PIB	111940	17	432	31½	800	28¾	730	28	13
Bins									
148BIN-WH	130008	9¼	235	14 ⁵ / ₈	371	23¾	591	White	
148BIN-YW	129980							Yellow	
148BIN-BL	182713							Blue	
Covers									
148COV	111931	Clear Plastic						1 Cover	
148COV-AL	693011	Aluminum						1 Cover	

Caster information:

Caster with 5" Polyurethane Wheel 757 (123684)

5" Polyurethane Wheel 7112 (122180)

Freight Class: 150

Oversized



Items highlighted in red are Express Ship. See details on page 148.



148PIB comes with three clear plastic covers. Aluminum covers sold separately.



148PIB

Heavy Duty Polyurethane Wheels





Medium Duty Sheet Pan Trucks Aluminum



D2027A-BPC

- Sanitary, all welded, reinforced, rustproof aluminum frame.
- **Life time Warranty Against Rust**
- Ideal for storing and transporting 18" x 26" trays. Side rail design securely holds trays in place.
- Model D2027A-BPC is equipped with top cross bars for additional shelf capacity.
- Casters Maneuvers easily on two swivel plate casters and two rigid plate casters with 4" polyurethane Wheels.



AP-1826

Trays
See page 126



D2027-BPC

Model Number	Order#	Overall Dimensions						Capacity		Approx. Ship Wt	
		Width		Length		Height		(lb)	(kg)	(lb)	(kg)
		(in)	(mm)	(in)	(mm)	(in)	(mm)				
D2027-BPC	111245	22	559	27	686	32	813	300	136	22	10
D2027A-BPC	111270	22	559	27	686	32	813	300	136	25	11

Caster information:
 Swivel Plate Caster with 4" Polyurethane Wheel 7351 (123211)
 Rigid Plate Caster with 4" Polyurethane Wheel 7418 (123369)
 4" Polyurethane Wheel 7125 (122403)

Freight Class: 92.5

Heavy Duty Sheet Pan Trucks Aluminum



D2027-BPC-51H-HD

- Sanitary, all welded, reinforced, rustproof aluminum frame.
- **Life time Warranty Against Rust**
- Ideal for storing and transporting 18" x 26" trays. Side rail design securely holds trays in place.
- Maneuvers easily on two 5" polyurethane swivel plate casters and two 5" polyurethane rigid plate casters.

Model Number	Order#	Overall Dimensions						Capacity		Approx. Ship Wt	
		Width		Length		Height		(lb)	(kg)	(lb)	(kg)
		(in)	(mm)	(in)	(mm)	(in)	(mm)				
D2027-BPC-51H-HD	688642	22½	560	27	686	51	1295	400	181	34	15

Caster information:
 Swivel Plate Caster with 5" Polyurethane Wheel 738AW (523039)
 Rigid Plate Caster with 5" Polyurethane Wheel 743W (523063)
 5" Polyurethane Wheel 7112 (122180)

Freight Class: 92.5



In line with our policy to continually improve our products, Winholt reserves the right to change materials and specifications without notice.



Heavy Duty Sheet Pan Trucks Galvanized

- Strong, all welded steel with, galvanized finish. Reinforced handles for easy maneuvering.
- Ideal for storing and transporting 18" x 26" trays. Holds approximately 100 - 18" x 26" pans.
- Casters: Rolls easily on four 5" polyurethane plate casters.

Model Number	Order#	Overall Dimensions						Capacity		Approx. Ship Wt	
		Width		Length		Height		(lb)	(kg)	(lb)	(kg)
		(in)	(mm)	(in)	(mm)	(in)	(mm)				
WHSPT-2128S	126017	21	533	28¾	718	28	711	600	272	35	16

Caster information:
 Swivel Plate Caster with 5" Polyurethane Wheel 738A (128784)
 5" Polyurethane Wheel 7112 (122180)
Freight Class: 92.5



WHSPT-2128S

Cup, Glass & Plate Rack Dollies

- All welded aluminum dollies, available in and two stack version.
- **Lifetime Warranty Against Rust**
- Two stack version great for hotels, convention centers and caterers.
- Rolls on 5" polyurethane swivel plate casters.



D-2020

Model Number	Order#	Overall Dimensions						Capacity		Approx. Ship Wt	
		Width		Length		Height		(lb)	(kg)	(lb)	(kg)
		(in)	(mm)	(in)	(mm)	(in)	(mm)				
D-2020	102154	21½	546	21½	546	8 ^{1/8}	914	600	272	12	5
D-2040/LD	632770	21½	546	41½	1054	8 ^{1/8}	914	600	272	18	8

Caster Information
 Swivel Plate Caster with 5" Polyurethane Wheel 738A (128784)
 5" Polyurethane Wheel 7112 (122180)
Freight Class: 100



Medium Duty Pizza Dough Box Dolly

- Multi-Purpose Pizza Dough Box Dolly is constructed of aluminum and holds 18" x 26" Pizza Dough Boxes and Trays.
- **Lifetime Warranty Against Rust**
- Rolls easily on heavy duty 4" rubber plate casters.

Options:

PH-1 (101830).....Pull Handle



D-2027

Model Number	Order#	Overall Dimensions						Capacity		Approx. Ship Wt	
		Width		Length		Height		(lb)	(kg)	(lb)	(kg)
		(in)	(mm)	(in)	(mm)	(in)	(mm)				
D-2027	126105	20	508	27	686	8	203	300	136	22	10

Caster Information
 Swivel Plate Caster with 5" Rubber Wheel 732 (123078)
 4" Rubber Wheel 716 (122673)
Freight Class: 100

PD-18253

Pizza Dough Boxes can be ordered on page 127



Tubular Dolly Aluminum Heavy Duty



TD-2428

- Sanitary, rustproof carts and dollies are ideal for all departments, transporting all types of products.
- Constructed of heavy duty, all welded, 1¼"x1½" rust proof aluminum square tubing.
- **Lifetime Warranty Against Rust.**
- Maneuvers on two rigid and two swivel polyolefin 6" plate casters.

Option:
PH-1 (101830) Pull Handle



6" Polyolefin Casters

Model Number	Order#	Overall Dimensions						Capacity		Approx. Ship Wt	
		Width		Length		Height		(lb)	(kg)	(lb)	(kg)
		(in)	(mm)	(in)	(mm)	(in)	(mm)				
TD-2428	102120	27	610	28	711	10	254	2,000	907	19	9

Caster Information
 Swivel Plate Caster with 6" Polyolefin Wheel 73111 (122972)
 Rigid Plate Caster with 6" Polyolefin Wheel 7412 (123318)
 5" Polyolefin Wheels 7020 (190553)
Freight Class: 100



Dolly Galvanized



DSN-2618

- Dolly is constructed of all welded galvanized steel. Dolly can be used for Sheet Pans (see page 130) or Stack & Nest Containers below.
- Maneuvers easily on two 5" rubber swivel plate casters and two 5" rubber rigid plate casters.
- The Stack and Nest Container improves efficiency and productivity.

Option:
Stack & Nest Container & Lids See chart below



SN-2618 Lug and LID-2618 Lid

Model Number	Ordering Number	Overall Dimensions						Approx. Ship Wt	
		Width		Length		Height		(lb)	(kg)
		(in)	(mm)	(in)	(mm)	(in)	(mm)		
Dolly – Galvanized Steel									
DSN-2618	102074	18	457	26	660	6	152	19	9
Lug – Gray Polyethylene									
SN-2618	104424	19	476	26	667	11	267	7	3
Lid – Gray Polyethylene									
LID-2618	104416	19	476	27	686	1	25	2	0.9

Caster Information
 Swivel Plate Caster with 4" Polyurethane Wheel 7351 (123211)
 Rigid Plate Caster with 4" Polyurethane Wheel 7418 (123398)
 4" Polyurethane Wheel 7125 (122403)
Freight Class: 100



UPS and the UPS brandmark are trademarks that are used with permission by the owner, United Parcel Service of America, Inc. All rights reserved.

Linen Transport & Storage Racks



B-16

- Model B-16 is constructed of an extra large sanitary white polyethylene tub built for heavy duty use which mounts on to a mobile, rust resistant, reinforced aluminum dolly
- **Lifetime Warranty Against Rust.**
- The unit maneuvers easily on four 4" swivel rubber casters.



**Also available are
3, 6 & 8 Bushel Bulk
Movers on page 93**

Model Number	Order#	Overall Dimensions						Capacity		Approx. Ship Wt	
		Width		Length		Height		(cu in)	(cu cm)	(lb)	(kg)
		(in)	(mm)	(in)	(mm)	(in)	(mm)				
B-16	101418	28	71	40	102	35	89	31,185	511,230	42	18

Caster Information

Swivel Plate Caster with 4" Rubber Wheel 732 (123078)

Freight Class: 250



Garment Rack

- Chrome plated steel tubing with tan powder coated base and bumpers.
- Unit standard with (2) 5" rigid plate polyurethane casters and (2) 5" swivel stem polyurethane casters.
- "H" nesting formation saves valuable floor space.
- Ships knock-down for extra freight savings.
- Quick and easy assembly.



WHGR-65-H-TN



**WHGR-65-Z-TN
Nesting Garment Racks
available upon request**

Caster Information

Rigid Threaded Stem Caster with 5-1/4" Polyurethane Wheel 7537W (523012)

Swivel Threaded Stem Caster with Polyurethane Wheel 7582W (523004)

Freight Class: 70

**Heavy Duty
Swivel Threaded
Stem Caster with
Polyurethane Wheel**



Model Number	Ordering Number	Overall Dimensions						Capacity		Approx. Ship Wt	
		Width		Length		Height		(lb)	(kg)	(lb)	(kg)
		(in)	(mm)	(in)	(mm)	(in)	(mm)				
WHGR-65-H-TN	524912	24	610	66	1,676	79	2,007	800	363	60	27

SHELVING

- Cantilever Shelving
- Adjustable Shelving
- Cooler & Back Room Shelving
- Correctional Shelving
- Dunnage Racks
- Aluminum Wall Shelves

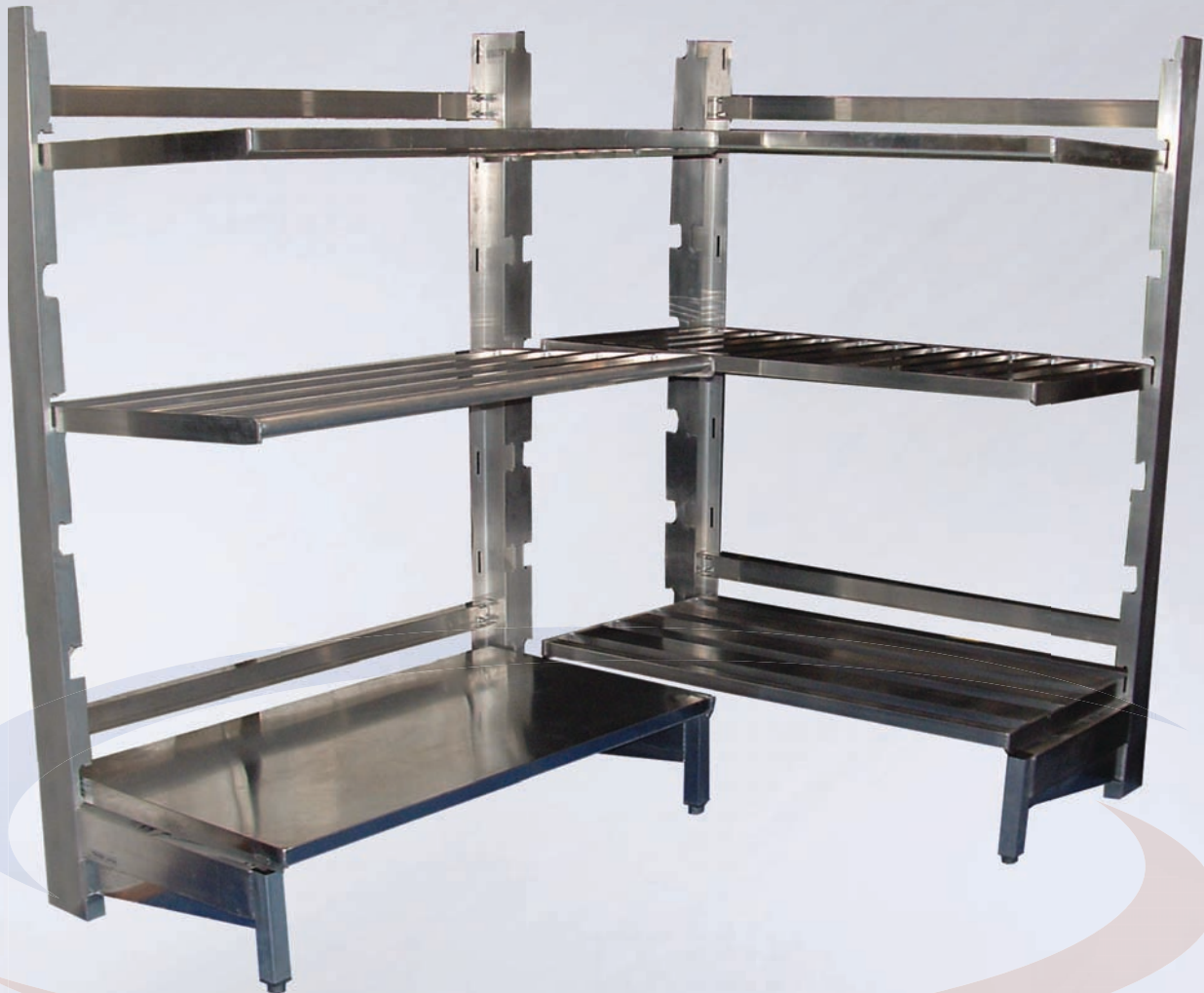

Cantilevered Shelving Heavy Duty Aluminum



- Maximizes storage, free Standing shelving allows access to all corners.
- **Lifetime Warranty Against Rust**
- Wall bolting not required.
- Perfect for coolers, freezers and backrooms.
- Holds up to seven shelves on 10" centers.
- "D" extrusion front shelves makes shelves more user friendly and easier to clean.
- Adjusts without tools-just lift and pull.
- **Shelves easily removeable for cleaning.**
- Posts are 72" high with front adjustable feet.
- Maximum capacity - 2,500 lb per section.



No corner posts maximizes storage



Starter Kit

- STARTER KIT INCLUDES**
- (1) Right Upright
 - (1) Left Upright
 - (2) Cross Braces
 - (3) or (4) Shelves
 - (1) Hardware Kit

Easy to Assemble!

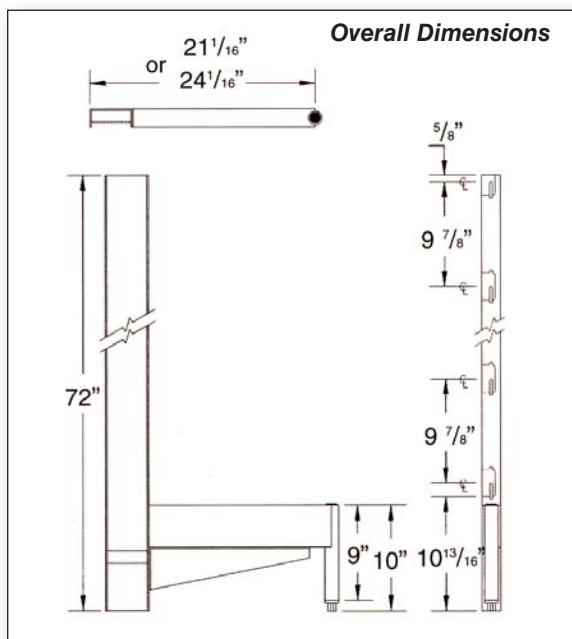

Add-On Kit

- ADD ON KIT INCLUDES**
- (1) Common Upright
 - (2) Cross Braces
 - (3) or (4) Shelves
 - (1) Hardware Kit

How to order your storage system using kits:

Build your unit beginning with a "Starter Kit" then select the appropriate "Add-On Kits" needed. To order this layout of shelving seen below you would order the following Kits:

Quantity	Model Number
(2)	SCAS-2436-3-SU
(2)	SCAS-2436-3-AU
(4)	SCAS-2460-3-AU
(1)	SCAS-2448-3-SU

Sample Freezer Layout 16' x 8'

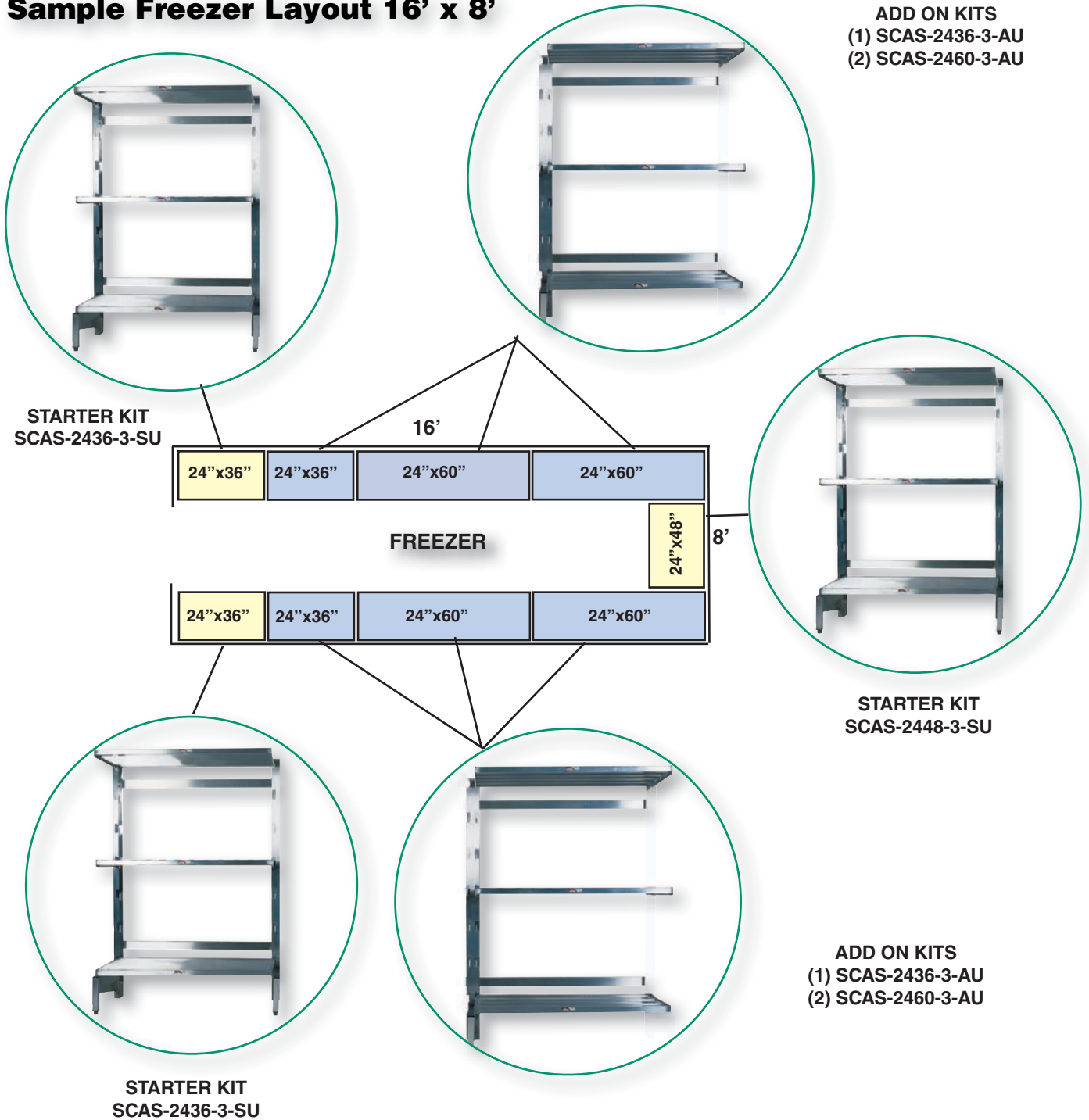

Starter Kits & Add On Kits Tubular Shelving Kits

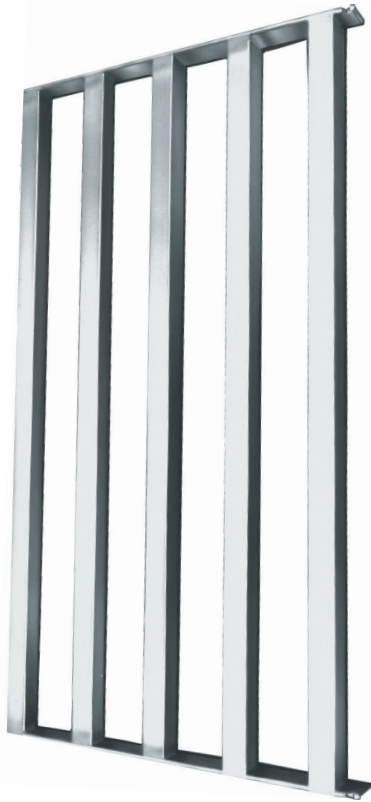

Tubular Shelving 1½" x 1½" aluminum tubing provides air circulation. 18" deep shelves have 4 tubes spaced 4" apart; 21" deep shelf has 4 tubes spaced 5" apart; 24" deep shelf has 5 tubes spaced 4" apart. Shelf Capacity - 900 lb (408 kg)

Shelving Sizes		"Starter Kits" Tubular Shelving	Approx. Ship Weight		"Add on Kits" Tubular Shelving	Approx. Ship Weight	
(in)	(mm)		(lb)	(kg)		(lb)	(kg)
3 SHELF UNITS							
18" Deep Shelves with 21" Deep Uprights							
18x36	457x914	SCAS-1836-3-SU	50	23	SCAS-1836-3-AU	54	25
18x48	457x1219	SCAS-1848-3-SU	57	26	SCAS-1848-3-AU	61	28
18x60	457x1524	SCAS-1860-3-SU	61	27	SCAS-1860-3-AU	65	29
21" Deep Shelves with 21" Deep Uprights							
21x36	533x914	SCAS-2136-3-SU	50	23	SCAS-2136-3-AU	54	25
21x48	533x1219	SCAS-2148-3-SU	57	26	SCAS-2148-3-AU	61	28
21x60	533x1524	SCAS-2160-3-SU	61	27	SCAS-2160-3-AU	65	29
24" Deep Shelves with 24" Deep Uprights							
24x36	610x914	SCAS-2436-3-SU	56	25	SCAS-2436-3-AU	60	27
24x48	610x1219	SCAS-2448-3-SU	63	28	SCAS-2448-3-AU	67	30
24x60	610x1524	SCAS-2460-3-SU	70	32	SCAS-2460-3-AU	74	34
4 SHELF UNITS							
18" Deep Shelves with 21" Deep Uprights							
18x36	457x914	SCAS-1836-4-SU	56	25	SCAS-1836-4-AU	60	27
18x48	457x1219	SCAS-1848-4-SU	66	30	SCAS-1848-4-AU	70	32
18x60	457x1524	SCAS-1860-4-SU	71	32	SCAS-1860-4-AU	75	34
21" Deep Shelves with 21" Deep Uprights							
21x36	533x914	SCAS-2136-4-SU	56	25	SCAS-2136-4-AU	60	27
21x48	533x1219	SCAS-2148-4-SU	66	30	SCAS-2148-4-AU	70	32
21x60	533x1524	SCAS-2160-4-SU	71	32	SCAS-2160-4-AU	75	34
24" Deep Shelves with 24" Deep Uprights							
24x36	610x914	SCAS-2436-4-SU	64	29	SCAS-2436-4-AU	68	31
24x48	610x1219	SCAS-2448-4-SU	77	35	SCAS-2448-4-AU	81	37
24x60	610x1524	SCAS-2460-4-SU	84	38	SCAS-2460-4-AU	88	40

Freight Class: 70

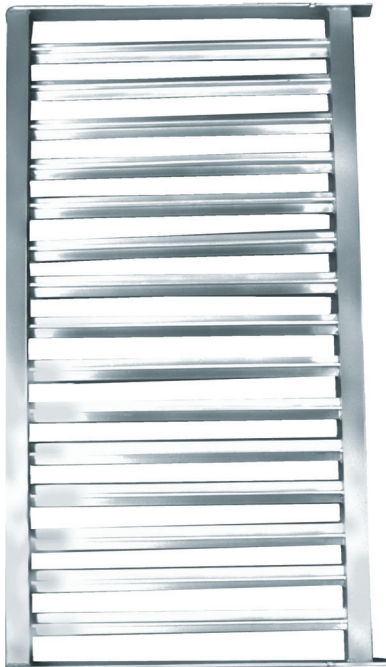

T-Bar Shelving 1" x 1½" T-Bar spaced 2" apart. Provides air circulation and allows boxes to slide on/off easily. Shelf Capacity - 700 lb (318 kg)

T-Bar Shelving Kits

Shelving Sizes		"Starter Kits" T-Bar Shelving	Approx. Ship Weight		"Add on Kits" T-Bar Shelving	Approx. Ship Weight	
(in)	(mm)		(lb)	(kg)		(lb)	(kg)
3 SHELF UNITS							
18" Deep Shelves with 21" Deep Uprights							
18x36	457x914	--	--	--	SCAST-1836-3-AU	54	25
18x60	457x1524	--	--	--	SCAST-1860-3-AU	65	29
24" Deep Shelves with 24" Deep Uprights							
24x36	610x914	SCAST-2436-3-SU	56	25	SCAST-2436-3-AU	60	27
24x48	610x1219	SCAST-2448-3-SU	63	28	SCAST-2448-3-AU	67	30
24x60	610x1524	SCAST-2460-3-SU	70	32	SCAST-2460-3-AU	74	34
4 SHELF UNITS							
18" Deep Shelves with 21" Deep Uprights							
18x36	457x914	SCAST-1836-4-SU	56	25	--	--	--
18x60	457x1524	SCAST-1860-4-SU	71	32	SCAST-1860-4-AU	75	34
24" Deep Shelves with 24" Deep Uprights							
24x36	610x914	SCAST-2436-4-SU	65	29	SCAST-2436-4-AU	69	31
24x48	610x1219	SCAST-2448-4-SU	75	34	SCAST-2448-4-AU	79	36
24x60	610x1524	SCAST-2460-4-SU	83	37	SCAST-2460-4-AU	87	39

Freight Class: 70

Starter Kits & Add On Kits

Solid Reinforced Shelving Kits



Shelving Sizes		Starter Kits Tubular Shelving	Approx. Ship Wt		Add on Kits" Tubular Shelving	Approx. Ship Wt	
(in)	(mm)		(lb)	(kg)		(lb)	(kg)
3 SHELF UNITS							
18" Deep Shelves with 21" Deep Uprights							
18x36	457x914	SCASS-1836-3-SU	59	27	SCASS-1836-3-AU	63	29
18x48	457x1219	SCASS-1848-3-SU	69	31	SCASS-1848-3-AU	73	33
18x60	457x1524	SCASS-1860-3-SU	79	36	SCASS-1860-3-AU	83	38
21" Deep Shelves with 21" Deep Uprights							
21x36	533x914	SCASS-2136-3-SU	62	28	SCASS-2136-3-AU	66	30
21x48	533x1219	SCASS-2148-3-SU	72	32	SCASS-2148-3-AU	76	34
21x60	533x1524	SCASS-2160-3-SU	85	38	SCASS-2160-3-AU	89	40
24" Deep Shelves with 24" Deep Uprights							
24x36	610x914	SCASS-2436-3-SU	65	29	SCASS-2436-3-AU	69	31
24x48	610x1219	SCASS-2448-3-SU	78	35	SCASS-2448-3-AU	82	37
24x60	610x1524	SCASS-2460-3-SU	88	40	SCASS-2460-3-AU	92	42
4 SHELF UNITS							
18" Deep Shelves with 21" Deep Uprights							
18x36	457x914	SCASS-1836-4-SU	69	31	SCASS-1836-4-AU	73	33
18x48	457x1219	SCASS-1848-4-SU	82	37	SCASS-1848-4-AU	86	39
18x60	457x1524	SCASS-1860-4-SU	95	43	SCASS-1860-4-AU	99	45
21" Deep Shelves with 21" Deep Uprights							
21x36	533x914	SCASS-2136-4-SU	73	33	SCASS-2136-4-AU	77	35
21x48	533x1219	SCASS-2148-4-SU	86	39	SCASS-2148-4-AU	90	41
21x60	533x1524	SCASS-2160-4-SU	103	47	SCASS-2160-4-AU	107	49
24" Deep Shelves with 24" Deep Uprights							
24x36	610x914	SCASS-2436-4-SU	77	35	SCASS-2436-4-AU	81	37
24x48	610x1219	SCASS-2448-4-SU	94	42	SCASS-2448-4-AU	98	44
24x60	610x1524	SCASS-2460-4-SU	107	48	SCASS-2460-4-AU	111	50

Freight Class: 70



Solid Reinforced Shelving

Aluminum sheet with aluminum cross tubes underneath for support. Ideal for smaller merchandise. Shelf Capacity - 700 lb (318 kg)

Channel Shelving Kits

Shelving Sizes		Starter Kits T-Bar Shelving	Approx. Ship Wt		Add on Kits T-Bar Shelving	Approx. Ship Wt	
(in)	(mm)		(lb)	(kg)		(lb)	(kg)
3 SHELF UNITS							
24" (610 mm) Deep Shelves with 24" Deep Uprights							
24x36	610x914	--	--	--	SCASCH-2436-3-AU	63	29
24x48	610x1219	--	--	--	SCASCH-2448-3-AU	70	32
24x60	610x1524	SCASCH-2460-3-SU	73	33	SCASCH-2460-3-AU	77	35
4 SHELF UNITS							
24" Deep Shelves with 24" Deep Uprights							
24x36	610x914	SCASCH-2436-4-SU	69	31	SCASCH-2436-4-AU	71	33
24x48	610x1219	SCASCH-2448-4-SU	78	35	SCASCH-2448-4-AU	80	37
24x60	610x1524	SCASCH-2460-4-SU	87	39	SCASCH-2460-4-AU	91	41

Freight Class: 70

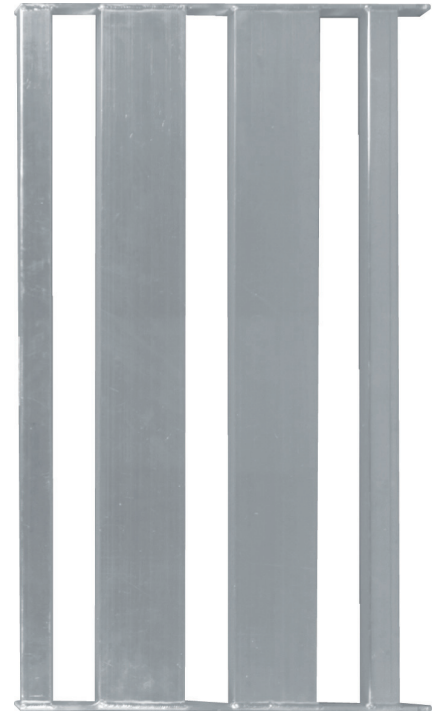

E Channel Shelving 4" x 1½" aluminum 14 gauge "E" Channel. Provides increased surface area, yet allows for air circulation. Channel is welded inside a frame of tubing and flat bar. 18" & 21" deep shelves have 2 channels, 24" deep shelf has 3 channels. Shelf Capacity - 1,000 lb (454 kg)



Design Your Storage System Cantilevered Shelving

It's Easy with Component Parts!



- You can design your storage system with our list of component parts.
- Maximize storage, free standing shelving allows access to all corners.
- **Lifetime Warranty Against Rust**
- Wall bolting not required.
- Perfect for coolers, freezers and backrooms.
- Holds up to seven shelves on 10" centers.
- "D" extrusion front shelves makes shelves user friendly and easier to clean.
- Adjusts without tools-just lift and pull.
- Posts are 72" high with front adjustable feet.
- Maximum capacity - 2,500 lb per section.

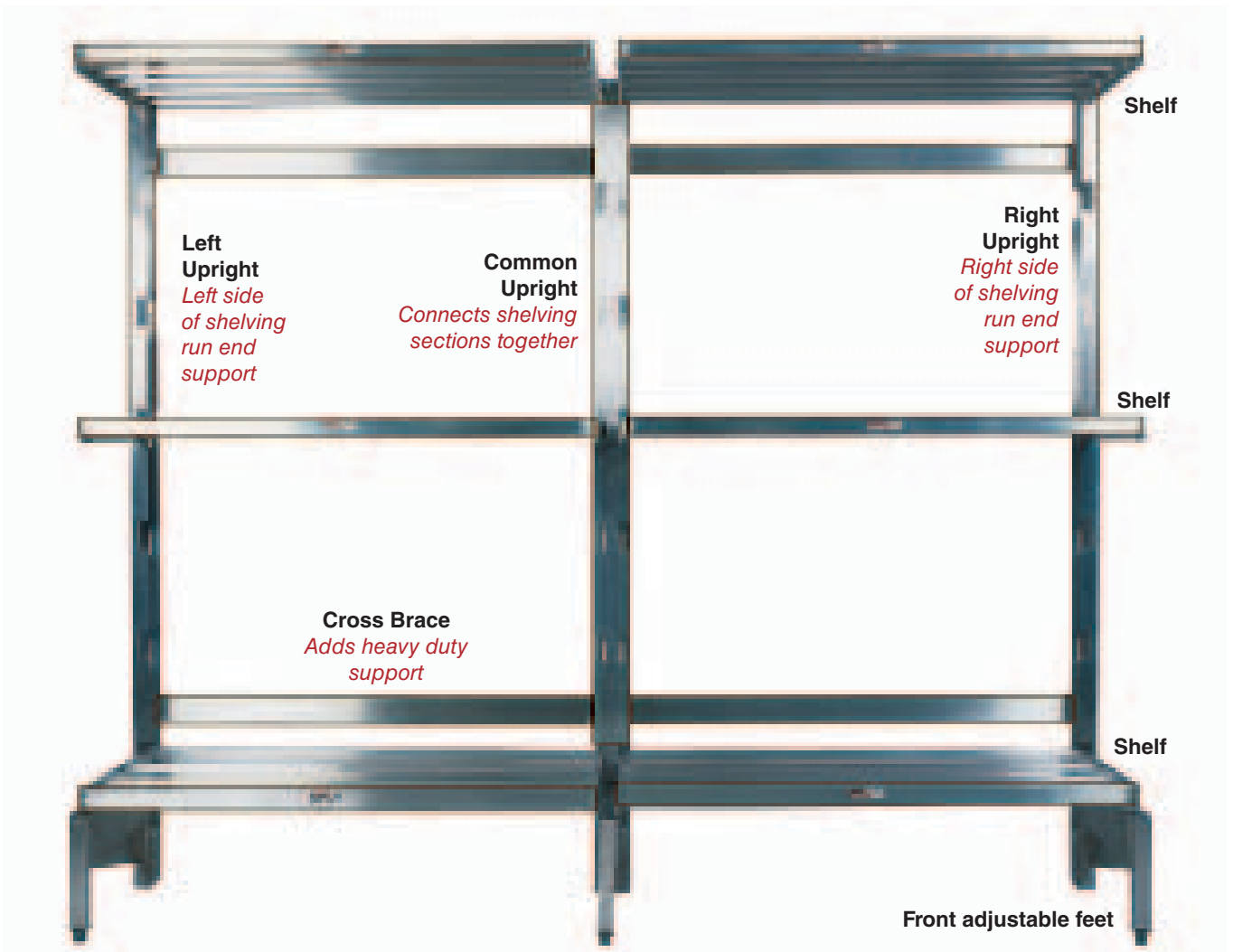

Cantilevered Shelving Heavy Duty Aluminum Component Part List

Ordering Instructions:

1.

Determine full shelving run length (i.e. 12 feet).

2.

Determine number of shelving sections required, using the least number of sections (a 12 ft run would use three - 4 ft sections).

3.

Select Shelf:

Type: Tubular, T-Bar, Solid or E-Channel

Depth: 18", 21" or 24" deep

Length for section: 3 ft, 4 ft, or 5 ft

Quantity per section: i.e. 4 shelves per section

4.

Order 3 ft, 4 ft, or 5 ft cross braces to match the section shelf size.

5.

Order a Left and Right Upright for each full run. Order Common Up rights for runs over 5 ft for use between sections.

6.

Order one Hardware Kit per section ordered.



Unique design offers full 45 degree angle of access in each corner!

Model Number	Ordering Number	Overall Dimensions		Approx. Ship Wt	
		(in)	(mm)	(lb)	(kg)
Tubular Shelves					
SCAS-1836	104820	18" x 36"	(457mm x 914mm)	7	3
SCAS-1848	104838	18" x 48"	(457mm x 1,219mm)	9	4
SCAS-1860	104846	18" x 60"	(457mm x 1,524mm)	10	5
SCAS-2136	104926	21" x 36"	(533mm x 914mm)	7	3
SCAS-2148	104934	21" x 48"	(533mm x 1,219mm)	9	4
SCAS-2160	104942	21" x 60"	(533mm x 1,524mm)	10	5
SCAS-2436	104969	24" x 36"	(610mm x 914mm)	9	4
SCAS-2448	104977	24" x 48"	(610mm x 1,219mm)	11	5
SCAS-2460	104985	24" x 60"	(610mm x 1,524mm)	13	6
Solid Reinforced Shelves					
SCASS-1836	105996	18" x 36"	(457mm x 914mm)	10	5
SCASS-1848	106008	18" x 48"	(457mm x 1,219mm)	13	6
SCASS-1860	106016	18" x 60"	(457mm x 1,524mm)	16	7
SCASS-2136	106075	21" x 36"	(533mm x 914mm)	11	5
SCASS-2148	106083	21" x 48"	(533mm x 1,219mm)	14	6
SCASS-2160	106091	21" x 60"	(533mm x 1,524mm)	18	8
SCASS-2436	106112	24" x 36"	(610mm x 914mm)	12	5
SCASS-2448	106121	24" x 48"	(610mm x 1,219mm)	16	7
SCASS-2460	106139	24" x 60"	(610mm x 1,524mm)	19	9
T-Bar Shelves					
SCAST-1836	163969	18" x 36"	(457mm x 914mm)	7	3
SCAST-1848	163977	18" x 48"	(457mm x 1,219mm)	9	4
SCAST-1860	163985	18" x 60"	(457mm x 1,524mm)	10	5
SCAST-2436	164021	24" x 36"	(610mm x 914mm)	9	4
SCAST-2448	164030	24" x 48"	(610mm x 1,219mm)	11	5
SCAST-2460	164048	24" x 60"	(610mm x 1,524mm)	13	6
E-Channel Cantilever Shelving					
SCASCH-2436	206762	24" x 36"	(610mm x 914mm)	10	5
SCASCH-2448	206771	24" x 48"	(610mm x 1,219mm)	12	5
SCASCH-2460	206789	24" x 60"	(610mm x 1,524mm)	14	6
Up-Rights					
SCASU-21L	106518	21" Left Upright for 18" & 21" Shelves		12	5
SCASU-21R	106526	21" Right Upright for 18" & 21" Shelves			
SCASU-24L	106542	24" Left Upright for 24" Shelves			
SCASU-24R	106551	24" Right Upright for 24" Shelves			
SCASU-21	106500	21" Common Upright for 18" & 21" Shelves		17	9
SCASU-24	106534	24" Common Upright for 24" Shelves			
Cross Braces and Hardware					
SCASC-36	105671	Cross Brace - Set of 2		4	2
SCASC-48	105689			5	2
SCASC-60	105697			6	3
SCAS-HW	105451			Hardware Kit - 1 for each section	

Other sizes available upon request.

Freight Class: 150



Uprights: 21" deep upright for 18" & 21" deep shelves. 24" deep uprights for 24" deep shelves. Heavy Duty 1/8" thick 4" x 1 3/4" aluminum channel holds up to seven shelves on 10" centers. 72" high with outer leg adjustable foot.

Cross Braces: 36", 48" and 60" lengths. Heavy duty aluminum channel 1" x 2 1/2" x 1/8".

Shelves: 18", 21" & 24" depths and 36", 48" & 60" lengths.



Sani-Adjustable Aluminum Shelving Component Parts

- You can design your storage system with our list of component parts.
- **Lifetime Warranty Against Rust**
- Perfect for coolers, freezers and backrooms.
- Holds up to seven shelves on 10" centers.
- Easily adjustable shelves.
- Posts come in a variety of heights to accommodate your requirements.

Easy Order Instructions for Component Parts

To order a 4 foot section with three Tubular shelves, 20" wide and 68" high, you need the following:

- (3) -SAS2048 (Tubular Shelves 20" x 48")
- (4) -SASP-68 (Poles 68" high)

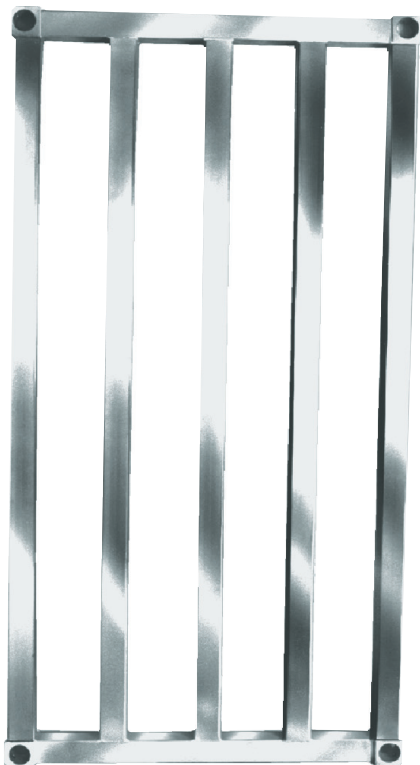

Tubular Shelving

- Constructed of all welded, heavy duty, sanitary aluminum 1 3/4" x 1 1/2" cross tubes for improved air circulation and strength.
- Shelf Capacity 2,000 lb (907 kg). Maximum evenly distributed static load capacity.

Model Number	Ordering Number	Overall Dimensions				# of Cross Tubes	Approx. Ship Wt	
		Width		Length			(lb)	(kg)
		(in)	(mm)	(in)	(mm)			
SAS1836	106981	18	457	36	914	4	8	4
SAS1848	107001			48	1,219		10	5
SAS1860	107019			60	1,524		12	5
SAS1872	107027			72	1,829		14	6
SAS2036	107060	20	508	36	914	4	8	4
SAS2048	107086			48	1,219		10	5
SAS2060	107094			60	1,524		12	5
SAS2072	107115			72	1,829		14	6
SAS2096	107123			96	2,438		15	7
SAS2436	107140	24	610	36	914	5	10	5
SAS2448	107166			48	1,219		13	6
SAS2460	107174			60	1,524		15	7
SAS2472	107182			72	1,829		18	8

Freight Class: 150

Tubular Shelving
SAS Series



In line with our policy to continually improve our products, Winholt reserves the right to change materials and specifications without notice.

Reinforced Solid Shelving

- Constructed of all welded, heavy duty, sanitary aluminum sheet metal with cross tubes underneath for extra strength.
- Shelf Capacity 800 lb (363 kg). Maximum evenly distributed static load capacity.

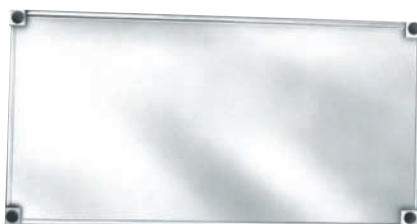

Reinforced Solid Shelving
SASSR Series Top View

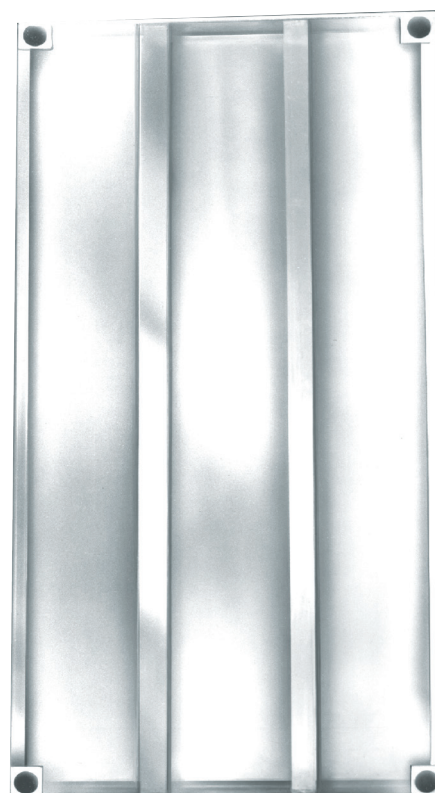

Reinforced Solid Shelving
SASSR Series

Model Number	Ordering Number	Overall Dimensions				Approx. Ship Weight	
		Width		Length		(lb)	(kg)
		(in)	(mm)	(in)	(mm)		
SASSR1848	107553	18	457	48	1,219	9	4
SASSR1860	107561			60	1,524	11	5
SASSR2036	107570	20	508	36	914	11	5
SASSR2048	107588			48	1,219	13	6
SASSR2060	107596			60	1,524	15	7
SASSR2436	107617	24	610	36	914	11	5
SASSR2448	107625			48	1,219	14	6
SASSR2460	107633			60	1,524	17	8

Freight Class: 150



Sani-Adjustable Shelving Poles

- With 2" marked increments for easy set-up. Standard with plastic caps on pole ends.
- 12" poles are ideal for knock-down Dunnage Racks.



Model Number	Ordering#	Approx. Height		Approx. Ship Weight	
		(in)	(mm)	(lb)	(kg)
SASP-54	107211	54	1,372	3	1
SASP-68	107220	68	1,727	4	2
SASP-76	107262	76	1,930	5	2
SASP-84	167775	84	2,134	6	3

Freight Class:150

Option:

SASP-ADJ (107297) Set of (4) Adjustable bullet feet.

Sani-Adjustable Shelving Mobile Kit

- Easy conversion from a stationary unit to a mobile unit.
- Overall Capacity 1,200 lb (544 kg).

Make any Sani-Adjustable Aluminum Shelving Mobile unit with SAS-MK Kit!

Model Number	Ordering Number	Description
SAS-MK	106913	(4) 5" Swivel Stem Casters

Freight Class: 70



SAS Mobile Unit
SAS-MK Kit

Cooler and Backroom Shelving

- Sanitary and easy to clean. Constructed of all welded, heavy duty, sanitary aluminum.
- Mobile units roll easily on two rigid and two swivel heavy duty casters, with 6" x 2" phenolic wheels.

All sizes available as mobile units



ALSCS



ALMCS
Heavy Duty 6" Casters

Model Number	Ordering Number	Overall Dimensions						# of Shelves	Approx. Ship Wt.		
		Width		Length		Height			(lb)	(kg)	
		(in)	(mm)	(in)	(mm)	(in)	(mm)				
Tubular Bar Style											
ALSCS-48-220	102269	20	508	48	1,219	60	1,524	2 34½" (876mm) Between Shelves	24	11	
ALSCS-48-224	102277	24	610						28	13	
ALSCS-60-220	102314	20	508	60	1,524	29	13				
ALSCS-60-224	102322	24	610			33	15				
ALSCS-36-320	143511	20	508	36	914	60	1,524	3 22½" (572mm) Between Shelves	26	12	
ALSCS-36-324	143693	24	610						31	14	
ALSCS-48-320	102285	20	508	48	1,219				31	14	
ALSCS-48-324	102293	24	610						37	17	
ALSCS-60-320	102331	20	508	60	1,524	36	16				
ALSCS-60-324	102349	24	610			44	20				
T-Bar Style											
ALSTB-48-320	165112	20	508	48	1,219	60	1,524		3 22½" (572mm) Between Shelves	36	16
ALSTB-48-324	152979	24	610					41		19	
ALSTB-60-320	165104	20	508	60	1,524			41		19	
ALSTB-60-324	152987	24	610					48		22	
E-Channel											
ALSCH-48-220	206498	20	508	48	1,219	60	1,524	2 34½" (876mm) Between Shelves		25	11
ALSCH-48-224	206501	24	610							29	13
ALSCH-60-220	206535	20	508	60	1,524					30	14
ALSCH-60-224	206543	24	610						34	15	
ALSCH-48-320	206586	20	508	48	1,219	60	1,524		3 22½" (572mm) Between Shelves	33	15
ALSCH-48-324	206594	24	610							39	18
ALSCH-60-320	206615	20	508	60	1,524					38	17
ALSCH-60-324	206623	24	610							46	21

Options:

Specify option by replacing the Model Number prefix with the following:

ALMCS For Mobile Tubular Bar Unit

ALMTB For Mobile T-Bar Unit

ALMCH For Mobile E-Channel Unit

For locking casters add suffix to the Model Number

LC Locking Caster

Caster Information

Swivel Plate Caster with 6" Phenolic Wheel & Brake 7311CBZ (256911)

Rigid Plate Caster with 6" Phenolic Wheel 746 (123481)

6" Phenolic Wheel 7119 (122331)

Freight Class: 400



Mobile Cooler Shelving

- Sanitary and easy to clean. Constructed of all welded, heavy duty, sanitary aluminum.
- Mobile units roll easily on two rigid and two swivel heavy duty casters, with 6" x 2" phenolic wheels.

Model Number	Ordering Number	Overall Dimensions						# of Shelves	Space Between Shelves		Approx. Ship Wt.	
		Width		Length		Height			(in)	(mm)	(lb)	(kg)
		(in)	(mm)	(in)	(mm)	(in)	(mm)					
Mobile - Tubular Bar Style												
ALMCS-36-424	180988	24	610	36	914	60	1,524	4	15 ¹ / ₈	384	70	32
ALMCS-48-320	102171	20	508	48	1,219	60	1,524	3	22 ¹ / ₂	572	65	29
ALMCS-48-324	102189	24	610	48	1,219	60	1,524	3	22 ¹ / ₂	572	73	33
ALMCS-60-320	186968	20	508	60	1,524	60	1,524	3	22 ¹ / ₂	572	76	34
ALMCS-60-324	132249	24	610	60	1,524	60	1,524	3	22 ¹ / ₂	572	80	36
Mobile - E-Channel												
ALMCH-48-220	244486	20	508	48	1,219	60	1,524	2	34 ¹ / ₂	876	40	18
ALMCH-48-320	244494	20	508	48	1,219	60	1,524	3	22 ¹ / ₂	572	50	23

Caster Information

Swivel Plate Caster with 6" Phenolic Wheel & Brake 7311CBZ (256911)

Rigid Plate Caster with 6" Phenolic Wheel 746 (123481)

6" Phenolic Wheel 7119 (122331)

Freight Class: 300

Option:

Specify options by adding suffix to Model Numbers listed above.

LC Locking Caster



ALMCS
Heavy Duty 6" Casters

Sani-Mobile Cooler Cart Heavy Duty

- Ideal for boxed beef. Constructed of all welded, heavy duty aluminum.
- Maneuvers easily on two 6" x 2" phenolic swivel plate casters and two 6" x 2" rigid plate casters.

Model Number	Ordering Number	Overall Dimensions						Capacity		Approx. Ship Wt.	
		Width		Length		Height		(lb)	(kg)	(lb)	(kg)
		(in)	(mm)	(in)	(mm)	(in)	(mm)				
SMC-63	102411	25	635	63	1,600	71	1,803	3,000	1,361	70	32

Caster Information

Swivel Plate Caster with 6" Phenolic Wheel & Brake 7311CBZ (256911)

Rigid Plate Caster with 6" Phenolic Wheel 746 (123481)

6" Phenolic Wheel 7119 (122331)

Freight Class: 300



SMC-63

In line with our policy to continually improve our products, Winholt reserves the right to change materials and specifications without notice.



Correctional All Welded Shelving

- All welded aluminum shelving for maximum weight capacities.
- Mitered corners help reduce contraband smuggling in correctional environments and increase strength and capacity of the unit.
- Plastic feet are standard.

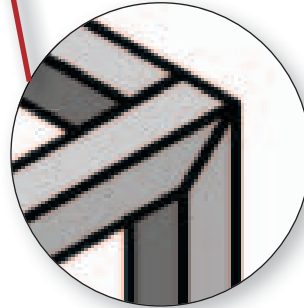

Mitered edges are contraband proof corners

Tubular Shelving

Great in freezers for increased air flow and where large boxes are stored. Shelf spacing on a 3 shelf unit is 22" and on a 4 shelf unit is 18". Capacity per shelf is 1500 lbs.

T-Bar Shelving

Great in cooler areas where small boxes and small food items may be stored. Shelf Spacing on a 3 shelf unit is 22" and on a 4 shelf unit is 18". Capacity per shelf is 1000 lbs.

To order T-Bar Shelving use the following:

Replace Prefix with "ALSTB" in the models in the chart.

Channel Shelving

This design gives you the best in strength and functionality. Stores boxes or small food items. Works great in dry storage, coolers and freezers. Shelf spacing on a 3 shelf unit is 22" and on a 4 shelf unit is 18". Capacity per shelf is 1500 lbs.

To order E-Channel Shelving use the following:

Replace Prefix with "ALSCH" in the models in the chart.

Model Number	# of Shelves	Dimensions (WxDxH)		Approx. Ship Weight	
		(in)	(mm)	(lbs)	(kg)
3 Shelves, 20" Deep					
ALSCS-36-320-CM	3	36 x 20 x 60	914 x 508 x 1524	26	12
ALSCS-42-320-CM	3	42 x 20 x 60	1067 x 508 x 1524	28	13
ALSCS-48-320-CM	3	48 x 20 x 60	1219 x 508 x 1524	31	14
ALSCS-52-320-CM	3	52 x 20 x 60	1321 x 508 x 1524	33	15
ALSCS-60-320-CM	3	60 x 20 x 60	1524 x 508 x 1524	36	16
ALSCS-72-320-CM	3	72 x 20 x 60	1829 x 508 x 1524	41	19
3 Shelves, 24" Deep					
ALSCS-36-324-CM	3	36 x 24 x 60	914 x 610 x 1524	31	14
ALSCS-42-324-CM	3	42 x 24 x 60	1067 x 610 x 1524	34	15
ALSCS-48-324-CM	3	48 x 24 x 60	1219 x 610 x 1524	37	17
ALSCS-52-324-CM	3	52 x 24 x 60	1321 x 610 x 1524	40	18
ALSCS-60-324-CM	3	60 x 24 x 60	1524 x 610 x 1524	44	20
ALSCS-72-324-CM	3	72 x 24 x 60	1829 x 610 x 1524	51	23
4 Shelves, 20" Deep					
ALSCS-36-420-CM	4	36 x 20 x 72	914 x 508 x 1829	41	18
ALSCS-42-420-CM	4	42 x 20 x 72	1067 x 508 x 1829	45	20
ALSCS-48-420-CM	4	48 x 20 x 72	1219 x 508 x 1829	49	22
ALSCS-52-420-CM	4	52 x 20 x 72	1321 x 508 x 1829	53	24
ALSCS-60-420-CM	4	60 x 20 x 72	1829 x 508 x 1829	57	26
ALSCS-72-420-CM	4	72 x 20 x 72	1829 x 508 x 1829	65	29
4 Shelves, 24" Deep					
ALSCS-36-424-CM	4	36 x 24 x 72	914 x 610 x 1829	48	22
ALSCS-42-424-CM	4	42 x 24 x 72	1067 x 610 x 1829	53	24
ALSCS-48-424-CM	4	48 x 24 x 72	1219 x 610 x 1829	58	26
ALSCS-52-424-CM	4	52 x 24 x 72	1321 x 610 x 1829	63	28
ALSCS-60-424-CM	4	60 x 24 x 72	1829 x 610 x 1829	68	31
ALSCS-72-424-CM	4	72 x 24 x 72	1829 x 610 x 1829	77	35

Freight Class: 400

Options: Specify options by adding suffix to Model Numbers

ADJ Adjustable Feet

MLC Mobile Unit with Casters



Dunnage Racks Economy

- Prolongs product life by circulating air underneath.
- 12" height above floor meets all sanitary health codes.
- All welded 1½" x 1½" heavy duty, rustproof aluminum tube construction.



DASQ Series
Economy
1½" x 1½"
Tubular Frame

Model Number	Ordering Number	Length		Capacity		Approx. Ship Wt	
		(in)	(mm)	(lb)	(kg)	(lb)	(kg)
20" (508mm) Width x 12" (305mm) Height							
DASQ-3-1220	133866	36	914	2100	953	8	4
DASQ-4-1220	133874	48	1,219	1800	816	11	5
DASQ-5-1220	133882	60	1,524	1500	680	12	5
24" (610mm) Width x 12" (305mm) Height							
DASQ-3-1224	133891	36	914	2100	953	10	5
DASQ-4-1224	133903	48	1,219	1800	816	12	5
DASQ-5-1224	133911	60	1,524	1500	680	14	6
20" (508mm) Width x 8" (203mm) Height							
DASQ-3-820	156161	36	914	2100	953	10	5
DASQ-4-820	154018	48	1,219	1800	816	12	5
DASQ-5-820	153550	60	1,524	1500	680	14	6
24" (610mm) Width x 8" (203mm) Height							
DASQ-3-824	138237	36	914	2100	953	10	5
DASQ-4-824	138245	48	1,219	1800	816	12	5
DASQ-5-824	153568	60	1,524	1500	680	14	6



Items highlighted in red are
Express Ship!
See page 148 for details.

Dunnage Racks Heavy Duty

- Prolongs product life by circulating air underneath.
- Supports high capacity loads on all welded 1¾" x 1½" aluminum tube construction.
- 12" height above the floor meets all sanitary health codes



ALSQ Series
1¾" x 1½"
Tubular Frame

Model Number	Ordering Number	Length		Capacity		Approx. Ship Wt	
		(in)	(mm)	(lb)	(kg)	(lb)	(kg)
20" (508mm) Width x 12" (305mm) Height							
ALSQ-3-1220	102971	36	914	3000	1,361	8	4
ALSQ-4-1220	103085	48	1,219	2500	1,134	10	5
ALSQ-5-1220	103202	60	1,524	2000	907	12	5
24" (610mm) Width x 12" (305mm) Height							
ALSQ-3-1224	102980	36	914	3000	1,361	10	5
ALSQ-4-1224	103093	48	1,219	2500	1,134	12	5
ALSQ-5-1224	103211	60	1,524	2000	907	14	6
20" (508mm) Width x 8" (203mm) Height							
ALSQ-3-820	103034	36	914	3,000	1,361	10	5
ALSQ-4-820	103181	48	1,219	2,500	1,134	12	5
ALSQ-5-820	103245	60	1,524	2,000	907	14	6
24" (610mm) Width x 8" (203mm) Height							
ALSQ-3-824	103042	36	914	3000	1,361	10	5
ALSQ-4-824	103190	48	1,219	2500	1,134	12	5
ALSQ-5-824	103253	60	1,524	2000	907	14	6

WIN-HOLT DUNNAGE RACK CAPACITY GUIDE			
Series	36" Length	48" Length	60" Length
DASQ	2100 lb	1800 lb	1500 lb
ALSQ	3000 lb	2500 lb	2000 lb
ALCH	3000 lb	2500 lb	2000 lb
DRAL	3000 lb	2500 lb	2000 lb

Freight Class: 70 



DRAL Series
Gusset Legs for
Heavy Loads



Dunnage Racks, Gusset Leg

- Gusset legs support heavy loads.
- All welded heavy duty, rustproof aluminum construction.
- Also available in Electroplated Steel with a minimum order of 50 units.
- Optional 1" Safety Flanged Foot available upon request.

Model Number	Order#	Length		Capacity		Approx. Ship Wt	
		(in)	(mm)	(lb)	(kg)	(lb)	(kg)
Aluminum - 20" (508mm) Width x 12" (305mm) Height							
DRAL-3-1220	103472	36	914	3,000	1,335	11	5
DRAL-4-1220	103499	48	1,219	2,500	1,113	14	6
Aluminum - 24" (610mm) Width x 12" (305mm) Height							
DRAL-3-1224	103481	36	914	3,000	1,335	11	5
DRAL-4-1224	103501	48	1,219	2,500	1,113	14	6
DRAL-5-1224	103528	60	1,524	2,000	890	15	7

Freight Class: 70



PLSQ Series

Dunnage Racks, Plastic

- Solid, one piece plastic construction will not chip, corrode or rust.
- All are a full 12" height which is double the HACCP guidelines.
- Rounded corners helps prevent bag puncturing.
- Dunnage Racks eliminate condensation buildup. Easy to wash or steam clean.
- PLSQ plastic is Gray, recyclable and
- DPLSQ is Black, regind recycled plastic.



DPLSQ Series
Recycled Plastic

Model Number	Order#	Length		Color	Capacity		Approx. Ship Wt	
		(in)	(mm)		(lb)	(kg)	(lb)	(kg)
22" (559mm) Width x 12" (305mm) Height NSF Approved								
PLSQ-3-1222-GY	207757	36	914	Gray	2,200	998	18	8
PLSQ-4-1222-GY	207765	48	1,219	Gray	2,200	998	21	10
PLSQ-5-1222-GY	207773	60	1,524	Gray	2,200	998	24	11
22" (559mm) Width x 12" (305mm) Height- Recycled Plastic								
DPLSQ-3-1222-BK	408292	36	914	Black	2,200	998	18	8
DPLSQ-4-1222-BK	229041	48	1,219	Black	2,200	998	21	10
DPLSQ-5-1222-BK	408305	60	1,524	Black	2,200	998	24	11

Freight Class: 70



All Items highlighted in red are Express Ship! See page 148 for details.



ALWMS-1236



Knock Down Wall Shelves Aluminum

- Add extra storage to any wall.
- Aluminum construction wall shelf
- Aluminum shelves feature a marine edge to help prevent spills from coming over the edges.

Model Number	Order#	Depth		Length		Approx. Ship Wt	
		(in)	(mm)	(in)	(mm)	(lb)	(kg)
Aluminum Shelves Knock Down							
ALWMS-1236	222498	12	300	36	900	8	3
ALWMS-1248	118720	12	300	48	1200	8	3
ALWMS-260	222455	12	300	60	1500	9	4

Freight Class: 70



FOOD HANDLING SUPERMARKET



Lug Carts
Bulk Movers
Platter Carts
Universal Carts
Crisping Racks
Insulated Table Display
Insulated Display
Insulated Table Display
Icing Cart
Film Wrappers



AL-L-6

Equipped with gusset legs for extra strength.

Mobile Lug Carts Aluminum and Stainless Steel

- For transporting and storage of all types of products, these work saving mobile carts minimize lifting and carrying. Cut down on product handling time.
- **Lifetime Warranty Against Rust**
- Carts are sanitary and easy to clean.
- The carts are constructed of rustproof, all-welded aluminum (AL) or stainless steel (SS) with no nuts or bolts to loosen.
- The carts have 10" spacing between runners.
- Maneuvers easily on four 5" heavy duty polyurethane swivel stem casters.

Aluminum

Model Number	Order Number	Overall Dimensions						Capacity (Lugs)	Approx. Ship Wt	
		Width		Length		Height			(lb)	(kg)
		(in)	(mm)	(in)	(mm)	(in)	(mm)			
AL-L-1	104176	16	406	25	635	19	483	1	12	5
AL-L-2	104230	16	406	28	711	35	889	2	14	6
AL-L-3	104264	19	483	27	686	41	1,041	3	16	7
AL-L-6	104281	19	483	27	686	71	1,803	6	22	10

Caster Information

Swivel Square Stem Caster with 5" Polyurethane Wheel 757 (123684)

5" x 1 1/4" Polyurethane Wheel 7112 (122180)

Freight Class: 250



Option: Specify options by adding suffix to Model Numbers

XB XHD Reinforced Upright

Lugs & Lids are sold separately, see page 129.
Available in Gray, White, Red & Blue.



Stainless Steel

Model Number	Order Number	Overall Dimensions						Capacity (Lugs)	Approx. Ship Wt	
		Width		Length		Height			(lb)	(kg)
		(in)	(mm)	(in)	(mm)	(in)	(mm)			
SS-L-1	104310	16	406	25	635	19	483	1	15	7
SS-L-2	104336	16	406	28	711	35	889	2	23	10
SS-L-3	104361	19	483	27	686	41	1,041	3	33	15
SS-L-6	104387	19	483	27	686	71	1,803	6	40	18

Caster Information

Swivel Square Stem Caster with 5" Polyurethane Wheel 757 (123684)

5" x 1 1/4" Polyurethane Wheel 7112 (122180)

Freight Class: 250



AL-L-1

In line with our policy to continually improve our products, Winholt reserves the right to change materials and specifications without notice.

Bulk Movers, 3, 6 & 8 Bushel Aluminum and Stainless Steel

- Ideal for all Departments - Meat, Produce, Fish and Deli. - Food Preparation - Pack out - Storage!
- **Lifetime Warranty Against Rust**
- The most useful tool for Backroom Processing!
- Use our efficient Department Color Coding System: Blue for Fish, Red for Meat, White for Produce.
- Large removable tub is constructed of sanitary, washable and steam cleanable polyethylene.
- Frame constructed of all-welded, rust proof aluminum or stainless steel see bottom of page to order stainless steel
- Maneuvers easily on four 5" swivel polyurethane casters.



**6 Bushel Unit
30-6-A/BL**



**3 Bushel
BLC-1**



**8 Bushel Unit
30-8-A/RD with
Drip Pan sold separately**

Model Number	Order Number	Overall Dimensions						Tub Color	Approx. Ship Wt	
		Width		Length		Height			(lb)	(kg)
		(in)	(mm)	(in)	(mm)	(in)	(mm)			
3 Bushel - 6,840 Cubic Inches (500 lb) Bulk Movers—Aluminum Base										
Complete Unit (frame and tub)										
BLC-1	101602	19	483	30	762	32	813	White	14	6
Tub only										
XT-BLC	101776	19	483	30	762	12	305	White	6	3
6 Bushel - 16,632 Cubic Inches (500 lb) Bulk Movers—Aluminum Base										
Complete Unit (frame and tub)										
30-6-A / WH	101477	24	610	33	838	36	914	White	28	13
30-6-A / BL	161111							Blue		
30-6-A / GY	153066							Gray		
30-6-A / RD	161103							Red		
Tub only										
TUB-6A-WH	101725	24	610	33	838	21	533	White	12	5
TUB-6A-BL	161146							Blue		
TUB-6A-GY	101709							Gray		
TUB-6A-RD	101717							Red		
8 Bushel - 20,664 Cubic Inches (500 lb) Bulk Movers—Aluminum Base										
Complete Unit (frame and tub)										
30-8-AL / WH	161120	22	559	38½	978	32	813	White	39	18
30-8-AL / BL	155942							Blue		
30-8-AL / RD	161138							Red		
Tub only										
TUB-8L-WH	101750	24	610	41	1,041	21	533	White	22	10
TUB-8L-BL	101733							Blue		
TUB-8L-RD	101741							Red		

Caster Information
Swivel Square Stem Caster with 5" Polyurethane Wheel 757 (123684)
5" x 1 ¼" Polyurethane Wheel 7112 (122180)

Complete Unit Freight Class:250

Tub Only Freight Class: 70

To order in Stainless Steel

For 6 and 8 bushel Stainless Steel Bulk Movers change the "A" in the model number to "S" or the "AL" to "SS"

Option:

PDP-6 (101645) Drip Pan, Plastic



Platter Carts, Aluminum and Stainless Steel

- Ideal for meat and produce departments, food service and non-food processing, transport and assembly applications.
- **Lifetime Warranty Against Rust**
- The carts are constructed of rustproof all welded aluminum (AL) or stainless steel (SS) with no nuts or bolts to loosen.
- Platters are held securely on 1½" angle runners. 6" spacing between runners.
- Maneuvers easily on four 5" heavy duty polyurethane swivel stem casters.



AL-1210

Aluminum

Model Number	Order#	Overall Dimensions						# of Trays	Approx. Ship Wt	
		Width		Length		Height			(lb)	(kg)
		(in)	(mm)	(in)	(mm)	(in)	(mm)			
AL-1010	103851	13	330	26	660	67	1,702	10 - 10"	30	14
AL-1210	103886	15	381	26	660	67	1,702	10 - 12"	22	10
AL-1810B	109840	20	508	26	660	67	1,702	10 - 18"	34	15
AL-1012	103860	13	330	26	660	67	1,702	12 - 10"	25	11
AL-1212	103915	15	381	26	660	67	1,702	12 - 12"	32	15
AL-1812B	109882	20	508	26	660	67	1,702	12 - 18"	34	15
AL-106	103878	13	330	26	660	43	1092	6-10"	25	11
AL-126	103931	15	381	26	660	43	1092	6-12"	27	12
AL-186	103958	20	508	26	660	43	1092	6-18"	29	13

Caster Information
Swivel Square Stem Caster with 5" Polyurethane Wheel 757 (123684)
5" x 1¼" Polyurethane Wheel 7112 (122180)

Freight Class: 250

Option: Specify options by adding suffix to Model Numbers

XB XHD Reinforced Upright



WHP-1230

See our full line of platters on Page 126

Stainless Steel



SS-126

Model Number	Order#	Overall Dimensions						# of Trays	Approx. Ship Wt	
		Width		Length		Height			(lb)	(kg)
		(in)	(mm)	(in)	(mm)	(in)	(mm)			
SS-1010	103974	13	330	26	660	67	1,702	10 - 10"	43	20
SS-1210	104011	15	381	26	660	67	1,702	10 - 12"	45	20
SS-1810B	110470	20	508	26	660	67	1,702	10 - 18"	51	23
SS-1012	103982	13	330	26	660	67	1,702	12 - 10"	47	21
SS-1212	104029	15	381	26	660	67	1,702	12 - 12"	50	23
SS-1812B	110488	20	508	26	660	67	1,702	12 - 18"	51	23
SS-106	104002	13	330	26	660	43	1092	6 - 10"	33	15
SS-126	104053	15	381	26	660	43	1092	6 - 12"	35	16
SS-186	104088	20	508	26	660	43	1092	6 - 18"	37	17

Caster Information
Swivel Square Stem Caster with 5" Polyurethane Wheel 757 (123684)
5" x 1¼" Polyurethane Wheel 7112 (122180)

Freight Class: 250



Universal Carts

- The carts are constructed of all-welded aluminum tubing.
- Will not rust like wire carts. Recessed shelves hold products more securely.
- Carts maneuver easily on four heavy duty polyurethane 5" stem casters.
- **Lifetime Warranty Against Rust**

UNAL-4, UNAL-6, UNAL-7-32, UNAL-8

- Hold all sizes of trays, pans, or lugs up to 18" x 26".
- Carts allow for easy packing and unpacking.
- The UNAL-7-32 (seven shelves), offers double capacity, shelves hold two 10" or 12" platters side by side.
- Note: The UNAL-8 does not accommodate lugs.

UNAL-5-WEG and UNAL-8-WEG

- Narrower design makes it perfect for trays and pans.

Model Number	Order#	Overall Dimensions						# of Shelves	Space Between Shelves		Capacity		Approx. Ship Wt	
		Width		Length		Height			(in)	(mm)	(lb)	(kg)	(lb)	(kg)
		(in)	(mm)	(in)	(mm)	(in)	(mm)							
UNAL-4	103616	21	533	27	686	43	1,092	4	10	254	800	363	22	10
UNAL-6	103691					67	1,702	6	11	279			26	12
UNAL-7-32	103747	28	711	32	813	68	1,727	7	9	229	1,200	544	65	29
UNAL-8	103771	21	533	27	686	67	1,702	8	7	178	800	363	30	14
UNAL-5-WEG	103659	16	406	32	813	42	1,067	5	7	178	800	363	30	14
UNAL-8-WEG	103798					67	1,702	8					40	18

Caster Information

Swivel Square Stem Caster with 5" Polyurethane Wheel 757 (123684)

5" x 1 1/4" Polyurethane Wheel 7112 (122180)

Freight Class: 250

Option: Specify options by adding suffix to Model Numbers

XB XHD Reinforced Upright



UNAL-8-WEG

For Lugs and Platters
see page 126 & 129



Crisping Racks

- For storage and handling. Facilitates restocking and rotation of stock.
- High capacity holds eight standard size 26 1/2" x 29 1/8" crisping baskets (sold separately WHBTT-1551, color russet).
- All Welded aluminum construction with post design.
- **Lifetime Warranty Against Rust**
- Cart maneuvers easily on 5" Polyurethane casters.

WHBTT-1551

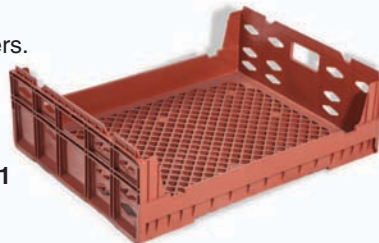

Model Number	Order#	Overall Dimensions						Approx. Ship Wt.	
		Width		Length		Height		(lb)	(kg)
		(in)	(mm)	(in)	(mm)	(in)	(mm)		
AL-3207CR/M	261892	32 1/2	826	29	737	79 3/4	2026	54	24
Crisping Tray									
WHBTT-1551	242739	26 1/2	572	29	737	9	229	7	3

Caster Information

Swivel Plate Caster with 5" Polyurethane Wheel 738A (128784)

Rigid Plate Caster with 5" Polyurethane Wheel 743A (128792)

5" Polyurethane Wheel 7112 (122180)

Freight Class: 250



AL-3207CR/M





SSMIT-4848-MLC-SNG-KIT

Insulated Table Display

- Stainless steel construction.
- **Lifetime Warranty Against Rust**
- Insulated ice pan, keeps food cold and allows your customers to self service - great for fish departments.
- Basket drain and shut off valve at the bottom.
- Includes (1) AL-L-1 with Lug for draining. Slide under table where the valve can be opened to drain, keeping things neat and clean.
- Maneuvers easily on (4) polyurethane swivel casters with brakes.
- We offer many different designs on display tables please contact your Winholt sales representative for more information.



Includes (1) AL-L-1 with Lug
Easily fits under the table to drain the unit.

Model Number	Order#	Overall Dimensions						Approx. Ship Wt	
		Width		Length		Height		(lb)	(kg)
		(in)	(mm)	(in)	(mm)	(in)	(mm)		
SSMIT-4848-MLC-SNG-KIT	688167	48	1219	48	1219	40 ^{1/4}	1022	156	760

Caster information:
Swivel Square Stem Caster w/ 5" Polyurethane Wheel & Brake 757ABK (206931)
Swivel Square Stem Caster with 5" Polyurethane Wheel 757 (123684)
5" Polyurethane Wheel 7112 (122180)
Freight Class: 200



Insulated Display

- Stainless steel all welded construction.
- **Lifetime Warranty Against Rust**
- (2) insulated removable ice trays, keeps food cold and offers your customers a self serve option to packaged merchandising. Great anywhere in the store.
- Removable ice bins have 2" Styrofoam insulation with drain tubes.
- Top shelf displays additional products.
- Maneuvers easily on (4) 5" polyurethane swivel casters (2) with brakes.



SSMI2T-4059/2MLC

Model Number	Order#	Overall Dimensions						Approx. Ship Wt	
		Width		Length		Height		(lb)	(kg)
		(in)	(mm)	(in)	(mm)	(in)	(mm)		
SSMI2T-4059/2MLC	992530	40	1061	56½	1423	60	1524	270	122

Caster Information
Swivel Plate Caster with 5" Polyurethane Wheel 738A (128784)
Swivel Plate Caster with 5" Polyurethane Wheel and Brake 738ABK (204185)
5" Polyurethane Wheel 7112 (122180)
Freight Class: 250



Insulated Adjustable Display Table

- Stainless steel all welded construction.
- **Lifetime Warranty Against Rust**
- Insulated removable ice bin keeps food cold and offers your customers a self serve option to packaged merchandising. Great anywhere in the store.
- Removable ice bins have 2" Styrofoam insulation, basket drain and shut off valve at the bottom.
- Use the removeable Lexan canopy for unpackaged food merchandising.
- Side Lexan side panels can also be removed.
- Maneuvers easily on (4) polyurethane swivel casters with brakes.

Use the table flat or adjust to 7.5 ° or 15 ° angle.

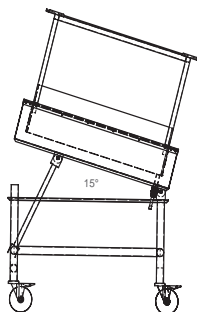

Model Number	Order#	Overall Dimensions						Approx. Ship Wt	
		Width		Length		Height		(lb)	(kg)
		(in)	(mm)	(in)	(mm)	(in)	(mm)		
SSMIT-3636MLC/CAN/ADJ	982745	36	914	36	914	51½	11308	190	86

Caster information:

Swivel Square Stem Caster with 5" Polyurethane Wheel & Brake 757ABK (206931)

Swivel Square Stem Caster with 5" Polyurethane Wheel 757 (123684)

5" Polyurethane Wheel 7112 (122180)

Freight Class: 200



We offer many different designs or we can custom design a display table which meets your needs.

Contact your Winholt sales representative for more information today.

Icing Cart

- Stainless steel all welded construction.
- **Lifetime Warranty Against Rust**
- Narrow cart designed for cake icing containers.
- Slanted shelves and stop bar are at a perfect working angle.
- Shelves are 17 1/2" apart
- Maneuvers easily on (4) swivel stem polyurethane casters.

Model Number	Order#	Overall Dimensions						Approx. Ship Wt	
		Width		Length		Height		(lb)	(kg)
		(in)	(mm)	(in)	(mm)	(in)	(mm)		
SSIC-1544-3S	378521	15	381	44	1118	52	1320	70	751

Caster Information

Swivel Square Stem Caster with 5" Polyurethane Wheel 757 (123684)

5" Polyurethane Wheel 7112 (122180)

Freight Class: 250





Film Wrappers

- Aluminum and stainless steel construction.
- **100% Pre-Tested**
- Sanitary and easily maintained, ETL Listed.
- Temperature controlled Teflon covered Hot Plate prevents sticking. Seals film to ensure food stays fresh and protected.
- Mounting Axle system. Accommodates rolls of film up to 18" and 8" diameter. Core adapter holds film rolls with a 3" diameter core.
- Complete line of ETL Listed replacement parts. Our parts are fully compatible with other popular brands.
- State-of-the-art components ensure reliability and long life functionality.
- Electrical loop rated @ 8AMPS, 115 volts; Overall 750 watts.

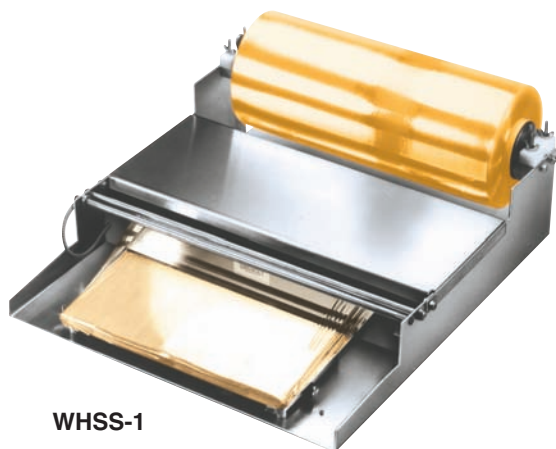

WHSS-1



WHSC-3

Model Number	Order#	# of Rolls	Hot Plate Dimensions		Overall Dimensions						Approx. Ship Wt	
			(in)	(mm)	Width		Length		Height		(lb)	(kg)
Table Model												
WHSS-1	112985	1	6 x 15	152 x 381	22¼	565	24	610	5	127	18	8
Console Model												
WHSC-3	112934	3	6 x 15	203 x 381	23	565	22	559	31½	800	27	12

Freight Class: 92.5
WHSS-1 only



Winholt offers a complete line of Film Wrapper Replacement Parts which are 100% Pre-Tested!

Our parts are fully compatible with other popular brands on the market.

To Order Parts see page 142

MERCHANDISERS

- Knock-Down Bread Racks
- Sample Demo Table
- Bagel and Bread Display Racks
- Adjustable Slant Merchandiser
- Plant & General Merchandiser
- Merchandiser Stands
- Mobile Merchandiser



Knock-Down Bread Rack



DRS-3660KD-WM

- All-welded sanitary aluminum construction. **Life time Warranty Against Rust**
- Ideal for fresh bread display to merchandising. Unit folds down for freight savings and easy storage.
- The rack holds 7 powder coated heavy-duty wire trays DRS-3660-GRID sold separately. See chart below.
- Maneuvers easily on non-marking polyurethane swivel casters two with brakes.
- All-welded sanitary aluminum construction.

Caster information:
 Swivel Plate Caster with 5" Polyurethane Wheel 738AW (523039)
 Swivel Plate Caster with 5" Polyurethane Wheel & Brake 738AW/LC (523055)
 5" Polyurethane Wheel 7112 (122180)
Freight Class: 250

Model Number	Order#	Overall Dimensions						Approx. Ship Wt	
		Width		Length		Height		(lb)	(kg)
		(in)	(mm)	(in)	(mm)	(in)	(mm)		
DRS-3660KD-WM	483225	59 ³ / ₈	1,499	35 ¹ / ₄	895	65	1,651	63	28
DRS-3660-GRID	484586	56 ¹ / ₂	1,429	34 ⁷ / ₈	864	1 ¹ / ₂	38	21	9



SSSC-3624MSD

Enclosed Stainless Steel Sample Demo Table

- All-welded sanitary stainless steel construction.
- **Lifetime Warranty Against Rust**
- Sanitary stainless steel sample demo table, allows you to move your product tastings from department to department.
- Great for product tasting and sample promo events.
- Convenient slide out draw and storage area keeps supplies handy and out of site.
- Maneuvers easily on 5" heavy duty polyurethane casters, two with brakes.

Model Number	Order#	Overall Dimensions						Approx. Ship Wt	
		Width		Length		Height		(lb)	(kg)
		(in)	(mm)	(in)	(mm)	(in)	(mm)		
SSSC-3624MSD	210121	24	610	36	914	37	940	94	43

Caster information:
 Swivel Plate Caster with 5" Polyurethane Wheel 738A (128784)
 Swivel Plate Caster with 5" Polyurethane Wheel & Brake 738ABK (204185)
 5" Polyurethane Wheel 7112 (122180)
Freight Class: 150



Bread and Bagel Display Racks with Removable Trays

- Material: Frame construction 1½” square steel tubing, fully welded.
- Shelves constructed of 18 gauge cold rolled steel, fully welded. Powder coat black paint, standard. Other colors available upon request.
- Application: Display merchandise, fresh baked bread & bakery products. Slanted shelves merchandise full surface of bakery products to customer. Removable crumb trays.
- Holds chrome bread bagel basket WSBB1118, sold separately see bottom of page.
- Maneuvers easily on 5” heavy duty polyurethane casters, front two with brakes.

Model Number	Order#	Description	Overall Dimensions						Capacity		Approx. Ship Wt.	
			Width		Length		Height		(lb)	(kg)	(lb)	(kg)
			(in)	(mm)	(in)	(mm)	(in)	(mm)				
DR-2443	365544	Bread Rack	43	1,092	24	610	72	1,829	600	272	145	65
DR-2143	365552	Bagel Rack	43	1,092	21	533	72	1,829	600	272	122	54

Caster information:
 Swivel Plate Caster with 5” Rubber Wheel 738 (123246)
 Swivel Plate Caster with 5” Rubber Wheel & Brake 738BK (207079)
 5” Rubber Wheel 7112 (122180)

Freight Class: 250

Options:

Specify options by adding suffix to Model Number
 Powder Coated:

RD	BK	TN	GR	WH
Red	Black	Tan	Green	White

KD Knock-down Design

Rack in Powder Coated Colors all ship Knock Down.

Bagel, Bread, and Bun Baskets

- Heavy duty, nickel chrome wire.
- Display, store and transport bulk baked goods.
- Allows customers to see full selection of bagels and rolls.

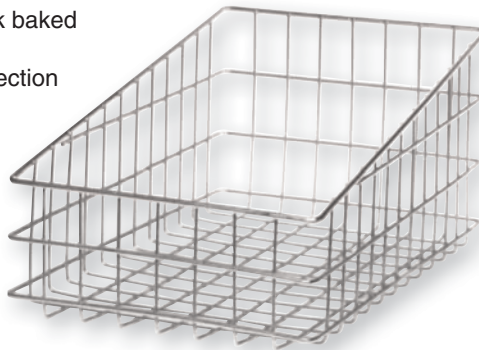

**Basket
WSBB1118**

Model Number	Order#	Description	Overall Dimensions						Approx. Ship Wt	
			Width		Length		Height		(lb)	(kg)
			(in)	(mm)	(in)	(mm)	(in)	(mm)		
WBB1319	207677	Chrome Basket, Level Top	13¾	349	19¾	502	5¾	146	4	2
WBB1723	207685	Chrome Basket, Level Top	17¾	451	23¾	603	8	203	7	4
WSBB1118	207714	Chrome Basket, Slant Top	11	279	18½	457	8	203	4	2



**Bagel Rack
DR-2143**



**Bread Rack
DR-2443**

Items highlighted in red are Express Ship!
 See page 148 for details.



Mobile Slant Merchandiser



- Constructed of all welded aluminum tubing. Light weight and easy to move.
- **Lifetime Warranty Against Rust**
- Great for produce, flowers or any general merchandise.
- Unit maneuvers easily on (2) 5" polyurethane swivel stem casters with brakes and (2) 5" polyurethane swivel plate casters.
- Rolling Capacity: 750 lb

Versatile unit can be put in three angled positions!



Model Number	Order#	Angle	Overall Dimensions						Capacity		Approx. Ship Wt.	
			Width		Length		Height		(lb)	(kg)	(lb)	(kg)
			(in)	(mm)	(in)	(mm)	(in)	(mm)				
MM-1948	630256	50° Angel					55	1397	750	340	35	16
		45° Angle	19	483	36	914	49 1/2	1257				
		Flat					20	508				

Caster information:
 Swivel Plate Caster with 5" Polyurethane Wheel 738A (128784)
 Swivel Plate Caster with 5" Polyurethane Wheel & Brake 738ABK (204185)
 5" Polyurethane Wheel 7112 (122180)
Freight Class: 150

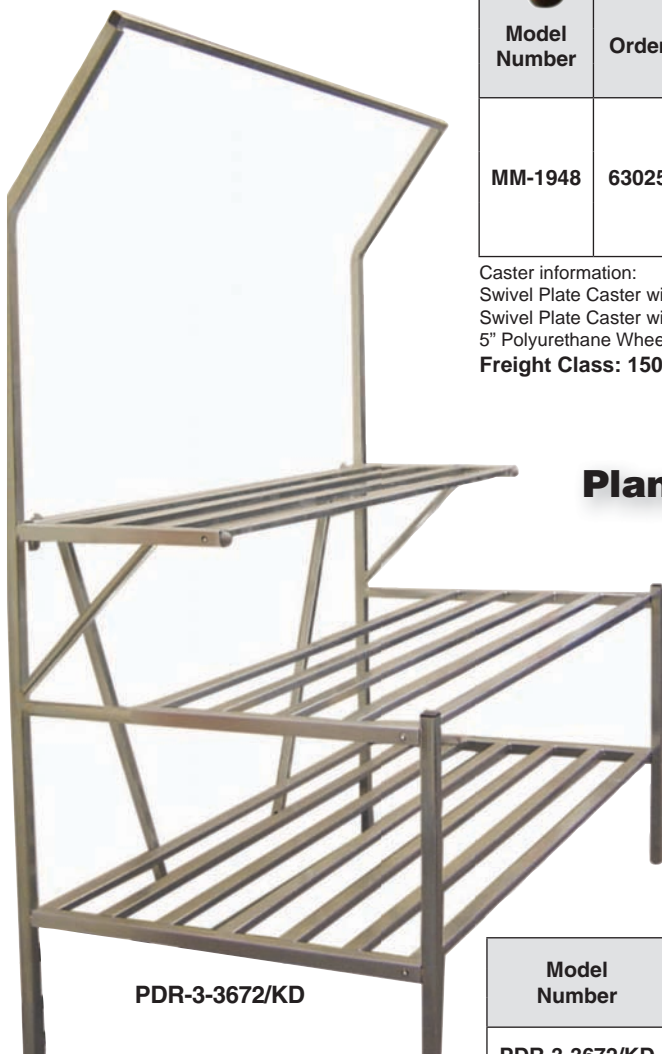

PDR-3-3672/KD

Plant & General Merchandiser

- Constructed of all welded steel tube with attractive bright nickel-chrome finish.
- Great for hanging plants. Two large shelves, one smaller shelf and overhead horizontal bar - to display and merchandise an array of plants or general merchandise.
- Unit ships knock-down for added freight savings.
- Assembles in minutes.

Model Number	Order#	Overall Dimensions						Capacity		Approx. Ship Wt.	
		Width		Length		Height		(lb)	(kg)	(lb)	(kg)
		(in)	(mm)	(in)	(mm)	(in)	(mm)				
PDR-3-3672/KD	487808	36	914	72	1828	83	2108	2000	907	200	91

Freight Class: 92.5

Merchandise Display Stands Double & Single

- All welded, plated, heavy duty, steel wire.
- Highlights your products with maximum visibility.
- Enhances customer impulse buying.
- Elevates products above the ground allowing the area underneath to be cleaned for more sanitary conditions.
- Protects your product and costs less than a case of merchandise.
- Nests for storage and freight savings.



W-1014

Highlights products and merchandise in aisles.

Multiple units can be used the length of the aisle to increase impulse sales.

Model Number	Order#	Overall Dimensions						Capacity		Approx. Ship Wt	
		Width		Length		Height		(lb)	(kg)	(lb)	(kg)
		(in)	(mm)	(in)	(mm)	(in)	(mm)				
W-1014	108231	10	254	14	356	8	203	500	227	5	2
W-2414	624366	14	356	24	610	8	203	850	386	8	4

Items highlighted in red are Express Ship!
See page 148 for details.

Freight Class: 125

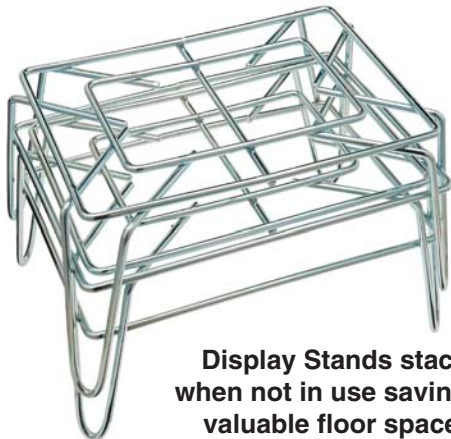

Display Stands stack when not in use saving valuable floor space!

Freight Savings too!

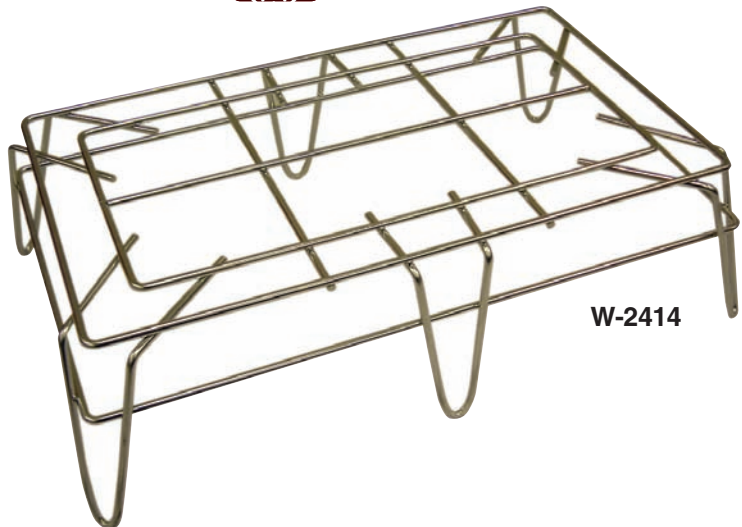

W-2414



Mobile Display Merchandiser

- Constructed of all welded, sanitary, rustproof, 1" square aluminum tubing.
- Four tier, unit has 12" between shelves.
- Holds eight 18" x 26" trays. See below.
- **Lifetime Warranty Against Rust**
- Versatile Mobile Display, designed to display a wide variety of merchandise-baked goods, produce, plates, etc.
- Casters: Maneuvers easily on four 5" polyurethane swivel casters.



Heavy Duty Polyurethane Wheels

AVT-4-2637/PU



Model Number	Order#	Overall Dimensions						Approx. Ship Wt	
		Width		Length		Height		(lb)	(kg)
		(in)	(mm)	(in)	(mm)	(in)	(mm)		
AVT-4-2637/PU	187961	26½	673	37	940	40¼	1,022	36	16

Caster information:
 Swivel Plate Caster with 5" Polyurethane Wheel 738A (128784)
 Swivel Plate Caster with 5" Polyurethane Wheel & Brake 738ABK (204185)
 5" Polyurethane Wheel 7112 (122180)
Freight Class: 250



Trays

- Sanitary, safe edged, fingertip grip design. All smooth surfaces for easy cleaning.
- We offer three materials; all with reinforced front and side edges.
- Seamless construction of sanitary, white polystyrene resists the corrosive attacks of food and meat acids, strong detergents and temperature changes.
- Constructed of injection molded, super hi-impact polystyrene with extra ribbing for rigidity and extra strength. Reinforced front and side edges provide additional impact resistance.

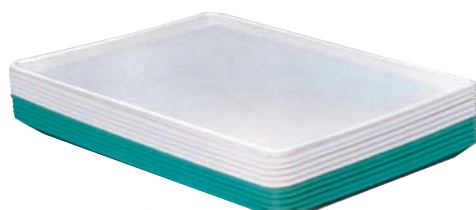

WHP-1826WABS



AP-1826

Model#	Order#	Overall Dimensions						Color	Approx. Ship Wt	
		Width		Length		Height			(lb)	(kg)
		(in)	(mm)	(in)	(mm)	(in)	(mm)			
WHP-1826WH	111843	18	457	26	660	1	25	White	3.5	1.6
WHP-1826WABS	111835	18	457	26	660	1	25	White ABS	3	1.3
WHP-1826GABS	111819	18	457	26	660	1	25	Green ABS	3	1.3
AP-1826	107991	18	457	26	660	1	25	Aluminum	3	1

Freight Class: 85

Items highlighted in red are Express Ship!
See details on page 148.

UPS and the UPS brandmark are trademarks that are used with permission by the owner, United Parcel Service of America, Inc. All rights reserved.





MATERIAL HANDLING EQUIPMENT

- U-Boats®
- Overstock Cart
- Platform & Nesting Carts
- Utility Carts
- Stocking & Marking Carts
- Wet Produce Cart
- Jumbo Bulk Mover
- Garment Rack
- Cart Corral
- Hand Trucks





“EZee Grip”[®] Handle

Ergonomic design keeps hands safely away from merchandise
Patent Pending



Cardboard Catcher[®]

Easy to attach accessory for fast, clutter-free stocking



Safety Bumper

Tough, absorbent polyethylene bumpers protect fixtures and people



Low Profile Design

25% lower profile improves safety

Ultra U-Boat[®]

- Constructed of all welded steel with anti-skid diamond plate steel deck.
- High density polyethylene molded full wrap around bumper.
- Ezee Grip Handle[®], ergonomically designed.
- Narrow 16” width deck, makes the use of this U-boat ideal for tight aisles. Deck height is 9⁹/₁₆”
- Maneuvers easily on two 8” stationary center load wheels and four 5” swivel end casters. Six wheel design allows cart to swivel on its own radius.
- Optional easy to attach Cardboard Catcher[®]



Rugged Diamond Deck
Non-skid surface, keeps boxes in place

Improved Stability
Wider wheel base increases stability by 30%

Higher Capacity
Wider wheel base and bigger casters for higher load capacity

Model Number	Order#	Overall Dimensions						Capacity		Approx. Ship Wt	
		Width		Length		Height		(lb)	(kg)	(lb)	(kg)
		(in)	(mm)	(in)	(mm)	(in)	(mm)				
300-60D-ULTRA	596166	16	406	60	1,524	61	1,549	2,000	907	76	34
Optional											
300-60D-HCH	609035	15½	394	12¾	324	32	812			25	11

Caster Information
Swivel Plate Caster with 5” Polyurethane Wheel **738A** (128784)
8” Polyurethane Center Wheel **7130** (122462)

Freight Class: 70

U-Boat[®], Cardboard Catcher[®] and EZee Grip Handle[®] are Registered Trademarks of Winholt Equipment Group.

U-Boat® Diamond Steel Deck - The Classic

- Narrow 16" width deck.
- Constructed of all welded steel with anti-skid diamond plate steel deck.
- All models have two high-end, removable handles to secure merchandise in place.
- Maneuvers easily on two 8" stationary center load wheels and four 4" swivel end casters. Six wheel design allows cart to swivel on its own radius.

**Maximize
Productivity
do the work of
5 Hand Trucks!**



300-60D/PU



**Polyurethane Wheels
for Heavy Duty
Applications, Long Life,
Low Maintenance,
Non-Marking.**



Model Number	Order#	Overall Dimensions						Capacity		Approx. Ship Wt	
		Width		Length		Height		(lb)	(kg)	(lb)	(kg)
		(in)	(mm)	(in)	(mm)	(in)	(mm)				
Utility Cart with Polyurethane Center & Polyurethane End Wheels											
300-48D / PU	100095	16	406	51	1,295	61	1,549	2,000	907	81	37
300-60D/PU	100343	16	406	63	1,600	61	1,549	2,000	907	95	43
Utility Cart with Mold-on Rubber Center & Rubber End Wheels											
300-48D	100079	16	406	51	1,295	61	1,549	1,850	839	81	37
300-60D	100271	16	406	63	1,600	61	1,549	1,850	839	95	43
Economy Utility Cart with Polyurethane Center & Polyurethane End Wheels											
D-60	100597	16	406	63	1600	61	1,549	1,200	545	95	43

Caster Information /PU models & D-60
 8" Polyurethane Center Wheel 7130 (122462)
 Swivel Plate Caster w/ 4" Polyurethane Wheel 7351 (123211)
 4" Polyurethane Wheel 7125 (122403)

Freight Class: 70

Caster Information 300-48D & 300-60D
 8" Mold-on Rubber Center Wheel 712 (128750)
 Swivel Plate Caster with 4" Rubber Wheel 732 (123078)

Freight Class: 70



D-60



P300-60PU with custom green handles

**Reinforced Steel Undercarriage
Lightweight!
Easy to Maneuver!**



U-Boat® with Plastic Deck

- Light weight, easy to clean, gray plastic deck.
- Plastic deck will not rust, discolor or warp.
- Ideal for indoor/outdoor use. Virtually maintenance free.
- End Handles and Frame constructed of all welded steel, powder coated gray.
- Narrow 18" width, designed for use in busy aisles. Anti-skid deck surface and two removable high-end handles prevent merchandise from sliding.
- Maneuvers easily on two 8" stationary center load wheels and four 4" polyurethane swivel end casters. Six wheel design allows cart to swivel within its own radius.



Model Number	Order#	Overall Dimensions						Capacity		Approx. Ship Wt	
		Width		Length		Height		(lb)	(kg)	(lb)	(kg)
		(in)	(mm)	(in)	(mm)	(in)	(mm)				
P300-60	185009	18	457	60	1,524	63	1,600	1,500	680	116	53
P300-60 / PU	185017	18	457	60	1,524	63	1,600	1,650	748	124	56

Caster Information P300-60
 8" Mold-on Rubber Center Wheel 712 (128750)
 Swivel Plate Caster with 4" Rubber Wheel 732 (123078)
 4" Rubber Wheel 716 (122673)
 Caster Information P300-60/PU
 8" Polyurethane Center Wheel 7130 (122462)
 Swivel Plate Caster w/ 4" Polyurethane Wheel 7351 (123211)
 4" Polyurethane Wheel 7125 (122403)

Freight Class: 70



Polyurethane Wheels
 for Heavy Duty
 Applications, Long Life, Low Maintenance, Non-Marking.

U-Boat® Accessories

Garment Bar

- This attachment converts our cart into a Garment Rack providing safe transportation of garments from shipment to warehouse to selling floor.
- This garment accessory offers you two carts in one!

Model Number	Ordering Number	Use on Models
GR-60KD / RX	204548	300-60D 300-60D / PU
4793	154448	Additional Race Fitting



Additional Reinforced Removable Shelves

- Multiple shelves help you to organize your merchandise.
- 300 series can be supplied with one top removable shelf.
- They also are available with one welded middle shelf.

Model Number	Ordering Number	Use on Models
AS-48	151001	300-48 300-48D / PU
AS-60	151010	300-60D 300-60D / PU
PAS-60	192541	P300-60



Bumper

Specify option by adding suffix to Diamond Steel Deck U-Boats Model Numbers listed on page 109, for (4) Bumpers mounted to cart.

Model Number	Ordering Number	Use on Models	
B	—	300-48D 300-60D	300-48D/PU 300-60D/PU

Freight Class: 150

Folding U-Boat® Aluminum

- Light weight, aluminum cart
- **Lifetime Warranty Against Rust**
- Handles fold for upright storage.
- End Handles and Frame constructed of all welded steel, powder coated gray.
- Narrow 16" width, designed for use in busy aisles.
- Maneuvers easily on two 6" stationary center load wheels and four 5" polyurethane swivel end casters. Six wheel design allows cart to swivel within its own radius.



Model Number	Order#	Overall Dimensions						Capacity		Approx. Ship Wt	
		Width		Length		Height		(lb)	(kg)	(lb)	(kg)
		(in)	(mm)	(in)	(mm)	(in)	(mm)				
AL-300-60-FH	661407	16	406	63	1600	60 ^{1/2}	1524	1,500	680	92	41

Caster Information
 6" Polyurethane Center Wheel 7417 (123351)
 Swivel Plate Caster w/ 5" Polyurethane Wheel 738A (128784)
 5" Polyurethane Wheel 7112 (122180)

Freight Class: 70



300-60D/SDR

U-Boat[®] with Slanted Shelves

- Great for overstock merchandise.
- Narrow 16" width deck.
- Constructed of all welded steel, three slanted shelves with turned "up" lip to prevent run off.
- Two high-end, removable handles secure merchandise in place.
- Convenient Tool Box.
- Maneuvers easily on two 8" stationary center load wheels and four 4" swivel end casters. Six wheel design allows cart to swivel on its own radius.

Model Number	Order#	Overall Dimensions						Capacity		Approx. Ship Wt	
		Width		Length		Height		(lb)	(kg)	(lb)	(kg)
		(in)	(mm)	(in)	(mm)	(in)	(mm)				
300-60D/SDR	268373	16	406	63	1,600	61	1,549	2,000	907	95	43

Caster Information:

- 8" Polyurethane Center Wheel 7130 (122462)
- Swivel Plate Caster w/ 4" Polyurethane Wheel 7351 (123211)
- 4" Polyurethane Wheel 7125 (122403)

Freight Class: 70



SC-1638-GR-FM

Overstock Stock Cart

- Great for overstock merchandise. Keeps inventory organized for quick and easy restocking
- Narrow 16" width deck, perfect in aisles.
- Constructed of all welded steel, with three slanted shelves and lip to prevent run off.
- Side handle makes movement of the cart easy.
- Optimizes backroom floor space and accessibility to stock.
- Standard color is green, other colors available upon request.
- Maneuvers easily on (4) 6" Polyurethane casters.

Caster Information

- Swivel Plate Caster w/ 6" Polyurethane Wheel 7326 (123131)
- Rigid Plate Caster w/ 6" Polyurethane Wheel 7417 (123351)
- 6" Polyurethane Wheel 7129 (122446)

Freight Class: 70

Model Number	Order#	Overall Dimensions						Capacity		Approx. Ship Wt	
		Width		Length		Height		(lb)	(kg)	(lb)	(kg)
		(in)	(mm)	(in)	(mm)	(in)	(mm)				
SC-1638-GR-FM	655314	16	406	42	1,600	61	1,549	2,000	907	100	45

Plastic Deck, Platform & Nesting Carts

- Ideal for indoor/outdoor use.
- Durable, gray plastic polyethylene deck, is reinforced with a honey comb construction which provides exceptional strength and durability.
- Lightweight, easy-to-clean, plastic deck will not rust, discolor or warp.
- Crossbar reinforces removable handle for extra strength and support.
- Anti-skid deck surface. Crossbar reinforces handle.
- Impact-absorbing front safety bumper and protective deck edging protect fixtures.
- Maneuvers easily on 6" x 2" mold-on rubber wheels.



Steel Reinforced Honeycomb construction Plastic Deck provides added strength and durability

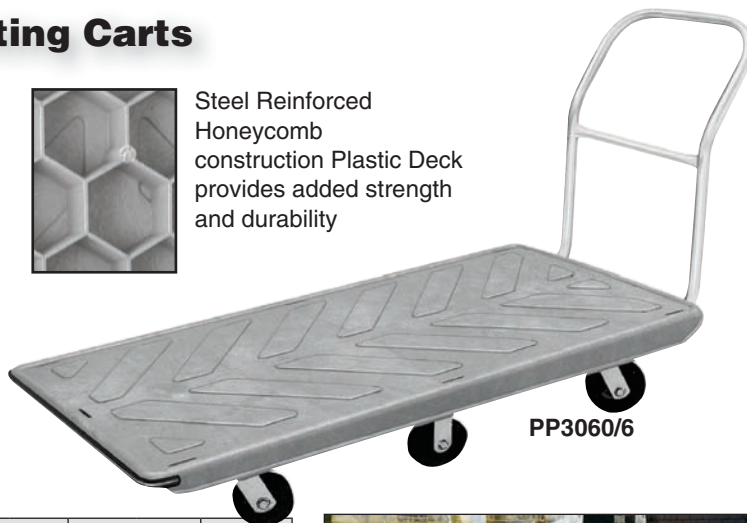

PP3060/6

Model Number	Order#	Description	Overall Dimensions						Capacity		Approx. Ship Wt	
			Width		Length		Height		(lb)	(kg)	(lb)	(kg)
			(in)	(mm)	(in)	(mm)	(in)	(mm)				
24" x 48" Platform Truck with 6" x 2" Mold-on Rubber Wheels												
PP2448/4	176719	4 Wheel Platform Truck	24	610	56	1,422	40	1,016	2,200	998	63	29
PP2448/6	176727	6 Wheel Platform Truck	24	610	56	1,422	40	1,016	2,400	1,088	79	36
30" x 60" Platform Truck with 6" x 2" Mold-on Rubber Wheels												
PP3060/4	174932	4 Wheel Platform Truck	30	762	65	1,651	40	1,016	2,200	998	99	45
PP3060/6	174941	6 Wheel Platform Truck	30	762	65	1,651	40	1,016	2,700	1,225	100	45
24" x 48" Nesting Cart with 6" x 2" Mold-on Rubber Wheels												
PN2448	176760	Nesting Cart	29 ³ / ₄	743	53 ³ / ₄	1,365	40	1,016	2,000	907	68	31
PN2448F	177842	w/Front Basket	29 ³ / ₄	743	53 ³ / ₄	1,365	40	1,016	2,000	907	68	31
PN2448R	177834	w/Rear Basket	29 ³ / ₄	743	53 ³ / ₄	1,365	40	1,016	2,000	907	68	31
30" x 60" Nesting Cart with 6" x 2" Mold-on Rubber Wheels												
PN3060	174959	Nesting Cart	35 ³ / ₄	895	65 ³ / ₄	1,670	40	1,016	2,000	907	110	50
PN3060F	177818	w/Front Basket	35 ³ / ₄	895	65 ³ / ₄	1,670	40	1,016	2,000	907	110	50
PN3060R	177826	w/Rear Basket	35 ³ / ₄	895	65 ³ / ₄	1,670	40	1,016	2,000	907	110	50



PN2448

Caster Information

H.D. Rigid Plate Caster with 6" Mold-on Rubber Wheel 7462CBZ (255100)
 H.D. Swivel Plate Caster with 6" Mold-on Rubber Wheel 7324CBZ (246641)
 6" Mold-On Rubber Wheel 711 (122155)

Freight Class: 100

Interchangeable with other carts on the market!

Nesting Customer Cart with Plastic Deck

- Durable, resilient, reinforced structural foam decks have honeycomb construction for exceptional strength.
- Compatible with other carts on the market.
- Powder coated gray frame with protective lacquer finish. Nests to conserve floor space.
- Maneuvers easily on 5" polyurethane wheels.

Caster Information

Swivel Plate Caster with 5" Polyurethane Wheel 738A (128784)
 Rigid Stem Caster with 5" Polyurethane Wheel 7537 (214990)
 5" Polyurethane Wheel 71121 (122198)

Freight Class: 100



PNC-1-WM/GR

Model Number	Order#	Overall Dimensions						Capacity		Approx. Ship Wt	
		Width		Length		Height		(lb)	(kg)	(lb)	(kg)
		(in)	(mm)	(in)	(mm)	(in)	(mm)				
PNC-1-WM/GR	1001021	24 ³ / ₄	629	40 ⁹ / ₁₆	1031	38	965	1200	534	50	23



SC-1848/6W/GN

Utility Stock Cart

- This utility stock cart is an excellent transporter for stockroom, shipping and selling floor.
- Constructed of square, heavy duty, all welded steel tube. Green Powder coated finish.
- 18" width is ideal for narrow aisles.
- Maneuvers easily on two 8" stationary center load wheels and four 6" polyurethane swivel end casters. Six wheel design allows cart to swivel within its own radius.

Polyurethane Wheels
for Heavy Duty Applications, Long Life, Low Maintenance, Non-Marking.



Standard color is Green
Other colors available upon request.

SC-1836/6W/RD

Model Number	Order#	Overall Dimensions						Capacity		Approx. Ship Wt	
		Width		Length		Height		(lb)	(kg)	(lb)	(kg)
		(in)	(mm)	(in)	(mm)	(in)	(mm)				
SC-1836/6W/GN	659083	18	629	43	1092	40	1016	1200	534	50	23
SC-1848/6W/GN	632374	18	629	55	1286	40	1016	1200	534	65	29

Caster Information
 8" Polyurethane Center Wheel 7130 (122462)
 Swivel Plate Caster w/ 5" Polyurethane Wheel 738A (128784)
 5" Polyurethane Wheel 7112 (122180)
Freight Class: 150

Utility Carts

- All welded angle iron steel construction stands up to heavy duty applications.
- Rounded front corners with two front bumpers protect store fixtures and doors. Standard color is blue.
- Retractable shelf is convenient for marking and packing out. Recessed tool tray is built into the handle.
- 550 series maneuvers easily on six wheels - four 5" rubber swivel plate casters and two heavy duty 6" rubber center wheels.

Increase productivity!



550 Series

Model Number	Order#	Feature	Overall Dimensions						Capacity		Approx. Ship Wt.	
			Width		Length		Height		(lb)	(kg)	(lb)	(kg)
			(in)	(mm)	(in)	(mm)	(in)	(mm)				
550	100722	6 Rubber Wheels	18	457	51	1,295	37	940	700	318	78	35
550HD	100757	HD Rubber Wheels	18	457	51	1,295	37	940	700	318	78	35
550HD / SX	100765	HD Rubber Wheels, Shelf & Tool Tray	18	457	51	1,295	37	940	700	318	80	36

Caster Information
 6" x 2" Mold-On Rubber Wheel 711 (122155)
 Swivel Plate Caster with 5" Rubber Wheel 738 (123246)
 5" Rubber Wheel 718 (122690)
Freight Class: 150

Ladder Truck

- All purpose truck is ideal for stocking, marking and reaching high shelves.
- Constructed of all welded steel with six wheel design for maximum maneuverability.
- Non-skid steps and handle bars assure secure grip and foot control.
- Maneuvers easily on four 5" swivel rubber and two 5" rigid rubber plate casters.



Stock Cart and Step Ladder all in one!

Option:

Specify options by adding suffix to Model Number listed below.

BP-2 (180902)...Bumpers (2)

Model Number	Order#	Overall Dimensions						Capacity		Approx. Ship Wt	
		Width		Length		Height		(lb)	(kg)	(lb)	(kg)
		(in)	(mm)	(in)	(mm)	(in)	(mm)				
LT-2	126252	24	610	50	1,270	53	1,346	1,000	454	140	63

Caster Information

Rigid Plate Caster with 5" Rubber Wheel 743 (123422)

Swivel Plate Caster with 5" Rubber Wheel 738 (123246)

5" Rubber Wheel 718 (122690)

Freight Class: 250



Rubber Wheels are Quiet and Economical

Stocking and Marking Carts

- This stocking and marking cart is an excellent transporter for stockroom, shipping and selling floor. Bottom shelf increases capacity.
- Constructed of square, heavy duty, all welded steel tube. Green powder coated finish.
- 18" width is ideal for narrow aisles.
- Rolls easily on two 5" swivel and two 5" rigid casters with 600 lb weight capacity.



Increase productivity!



Model Number	Order#	Overall Dimensions						Capacity		Approx. Ship Wt	
		Width		Length		Height		(lb)	(kg)	(lb)	(kg)
		(in)	(mm)	(in)	(mm)	(in)	(mm)				
110	126543	18	457	40	991	41	1041	600	272	44	20

Caster Information

Swivel Plate Caster with 5" Polyurethane Wheel 738A (128784)

Rigid Plate Caster with 5" Polyurethane Wheel 743A (128792)

5" Polyurethane Wheel 7112 (122180)

Freight Class: 250



Heavy Duty Polyurethane Wheels

Stocking and Marking Carts



- Constructed of all welded steel .
- Galvanized top shelf and bottom tubular shelf with a vertical upright frame design. Two bumpers on corners.
- Maneuvers on two 5" polyurethane swivel casters and two 5" polyurethane rigid plate casters.
- Cart has a capacity of 700l bs.

WX-1000KA/B-WM

**Easy grip handle.
Ergonomic Design.
Designed for Efficiency!**

Model Number	Order#	Overall Dimensions						Approx. Ship Wt	
		Width		Length		Height		(lb)	(kg)
		(in)	(mm)	(in)	(mm)	(in)	(mm)		
WX-1000KA/B-WM	524971	20	508	41	1041	31	787	59	27

Caster Information

Swivel Plate Caster with 5" Polyurethane Wheel 738A (128784)

Rigid Plate Caster with 5" Polyurethane Wheel 743A (128792)

5" Polyurethane Wheel 7112 (122180)

Freight Class: 100



ALUC-2-2036/36H

Aluminum Utility Stock Cart Heavy Duty

- Ideal cart for universal applications in all departments.
- Heavy duty channel construction, all welded aluminum cart.
- Two shelf unit rolls easily on 5" polyurethane casters, two swivel and two rigid



**Heavy Duty
Polyurethane
Wheel**

Model Number	Order#	Overall Dimensions						Capacity		Approx. Ship Wt	
		Width		Length		Height		(lb)	(kg)	(lb)	(kg)
		(in)	(mm)	(in)	(mm)	(in)	(mm)				
ALUC-2-2036/36H	624251	20	508	42	1067	36	914	1,200	544	36	16

Caster Information

Swivel Plate Caster with 5" Poly Wheel & Brake 738ABK (209185)

Rigid Plate Caster with 5" Poly Wheel 743A (127892)

5" Polyurethane Wheel 7112 (122180)

Freight Class: 250



Aluminum Sani Stock Carts T-Bar or Tubular Deck Heavy Duty

- All welded, sanitary, aluminum design. Uprights and handles are secured in place by heavy duty, welded collars.
- **Lifetime Warranty Against Rust.**
- Ideal cart for universal applications in all departments.
- T-Bar Shelves or Tubular Shelf decks.
- Easily maneuverable on two 5" swivel plate and two rigid plate polyurethane casters.



TBST-1837
T-Bar Shelf Decks

ALUC-2-2036-T
Tubular Shelf Deck



Model Number	Ordering Number	Overall Dimensions						Capacity		Approx. Ship Wt	
		Width		Length		Height		(lb)	(kg)	(lb)	(kg)
		(in)	(mm)	(in)	(mm)	(in)	(mm)				
T-Bar Deck											
TBST-1837	137411	18	457	39	991	37	940	300	136	30	14
Tubular Deck											
ALUC-2-2036-T	662549	20	508	42	1067	40	1016	700	315	35	16
ALUC-2-2048-T	663058	20	508	54	1372	40	1016	700	315	47	21

Caster Information

Swivel Plate Caster with 5" Poly Wheel & Brake 738ABK (204185)

Rigid Plate Caster with 5" Poly Wheel 743A (128792)

5" Polyurethane Wheel 7112 (122180)

Freight Class: 250



Utility Stock Cart

- All welded, tubular steel construction with aluminum powder coated finish.
- Gusseted uprights for added strength.
- Ideal cart for universal applications in all departments.
- Maneuvers easily on two 6" stationary center load wheels and four 4" polyurethane swivel end casters. Six wheel design allows cart to swivel within its own radius.

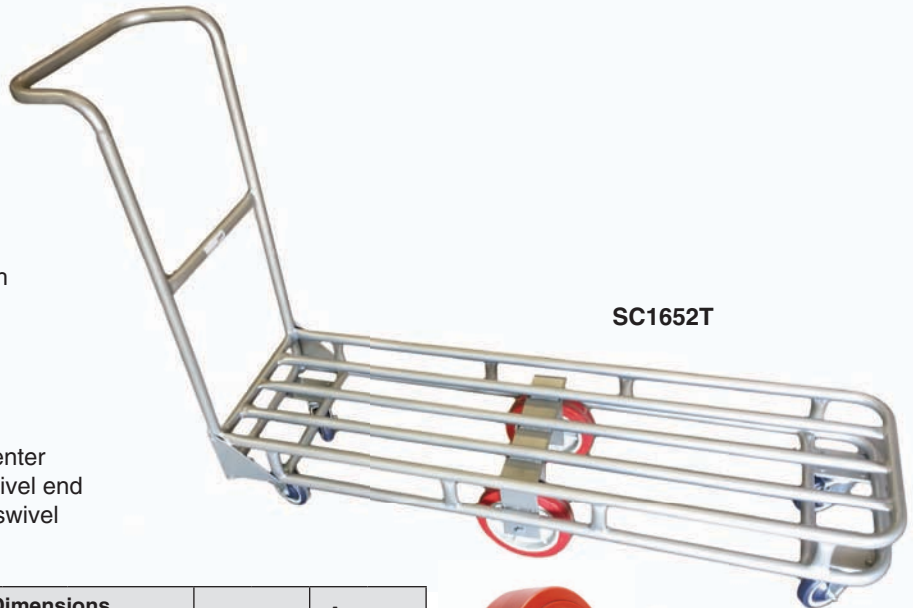

SC1652T

Model Number	Order#	Overall Dimensions						Capacity		Approx. Ship Wt	
		Width		Length		Height		(lb)	(kg)	(lb)	(kg)
		(in)	(mm)	(in)	(mm)	(in)	(mm)				
SC1652T	232223	16	508	42	1067	36	914	1,200	544	36	16

Caster Information

8" Polyurethane Center Wheel **7130** (122462)

Swivel Plate Caster with 4" Rubber Wheel 732 (123078)

4" Rubber Wheel 716 (122673)

Freight Class: 70



Polyurethane Wheels for Heavy Duty Applications, Long Life, Low Maintenance, Non-Marking.



9000-STK4
Powdercoated finish

- Model 9000-STK4 constructed of all welded, steel frame with wire mesh top shelf and tubular bottom shelf. Powder coated silver finish.
- Model 500CH constructed of all welded steel tube with attractive bright nickel-chrome finish.
- Carts roll easily on two 5" rubber swivel and two rigid casters.

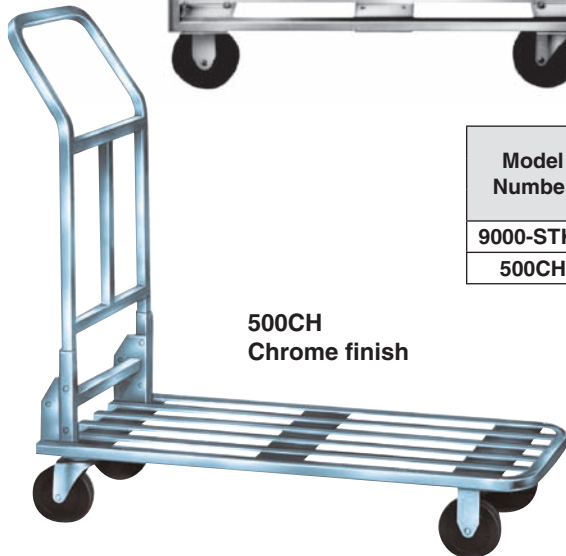

500CH
Chrome finish

Model Number	Order#	Overall Dimensions						Capacity		Approx. Ship Wt	
		Width		Length		Height		(lb)	(kg)	(lb)	(kg)
		(in)	(mm)	(in)	(mm)	(in)	(mm)				
9000-STK4	137533	18½	470	44	1,118	38¼	972	400	181	47	21
500CH	185025	18	457	37	940	41	1,041	750	339	40	18

Caster Information
 Swivel Plate Caster with 5" Rubber Wheel 738A (128794)
 Rigid Plate Caster with 5" Rubber Wheel 743A (128792)
 5" Rubber Wheel 718 (122690)
Freight Class: 250



WPT-2340

Wet Produce Carts Galvanized Steel and Aluminum

- This versatile wet produce cart, designed to handle wet items, is equipped with a removable and reversible pan to accommodate a variety of items.
- Model WPT-2340 constructed of galvanized steel.
- Model WPT-2340-AL constructed of light weight aluminum with self-adhesive polypropylene bumpers.
- Maneuvers easily on two 5" swivel polyurethane and two 5" rigid polyurethane casters.

Option:
 Specify option by adding suffix to Model Number listed.
BP-2 (180902)...Bumpers (2)

Heavy Duty
Polyurethane
Wheel



Model Number	Order#	Overall Dimensions						Capacity		Approx. Ship Wt	
		Width		Length		Height		(lb)	(kg)	(lb)	(kg)
		(in)	(mm)	(in)	(mm)	(in)	(mm)				
WPT-2340	126594	25	635	42	1,067	36	914	600	272	70	32
WPT-2340-AL	487947	25	635	42	1,067	36	914	600	272	55	25

Caster Information WPT-2340
 Swivel Plate Caster with 5" Polyurethane Wheel 738AW (523039)
 Rigid Plate Caster with 5" Polyurethane Wheel 743A (523063)
 5" Polyurethane Wheel 7112 (122180)
Freight Class: 250

Caster Information WPT-2340-AL
 Swivel Plate Caster with 5" Polyurethane Wheel 738A (128784)
 Rigid Plate Caster with 5" Polyurethane Wheel 743A (128792)
 5" Polyurethane Wheel 7112 (122180)
Freight Class: 250

Extra Large Jumbo Bulk Mover

- Model B-16 is constructed of an extra large sanitary white polyethylene tub built for heavy duty use which mounts on to a mobile, rust resistant, reinforced aluminum dolly
- **Lifetime Warranty Against Rust.**
- The unit maneuvers easily on four 4" swivel rubber casters.

Caster Information
Swivel Plate Caster with 4" Rubber Wheel 732 (123078)
Freight Class: 250



B-16

Model Number	Order#	Overall Dimensions						Capacity		Approx. Ship Wt	
		Width		Length		Height		(cu in)	(cu cm)	(lb)	(kg)
		(in)	(mm)	(in)	(mm)	(in)	(mm)				
B-16	101418	28	71	40	102	35	89	31,185	511,230	60	27

Garment Rack

- Steel Tubular H Frame construction, with powder coated tan base and (4) bumpers to protect store fixtures.
- Unit maneuvers easily on (4) 5" polyurethane wheels.
- Shipped knock-down for extra freight savings.
- Quick and easy assembly.

Nesting Design
Garment Racks
available upon request



WHGR-65-H-TN

Model Number	Order#	Overall Dimensions						Capacity		Approx. Ship Wt	
		Width		Length		Height		(lb)	(kg)	(lb)	(kg)
		(in)	(mm)	(in)	(mm)	(in)	(mm)				
WHGR-65-H-TN	524912	24	610	66	1,676	79	2,007	800	363	60	27

Freight Class: 70

Cart Corrals

- Constructed of galvanized flow-coat tubing.
- Flow coating protects the unit from outdoor elements.
- Ships with standard sign "Please Return Carts Here"
- Custom signs with your logo are available. Please call for a quote.

Option:

CCRL-1S1R-1SWM-PLASTIC-WT (578929) Plastic side weights hold unit in place when you cannot mount to asphalt.

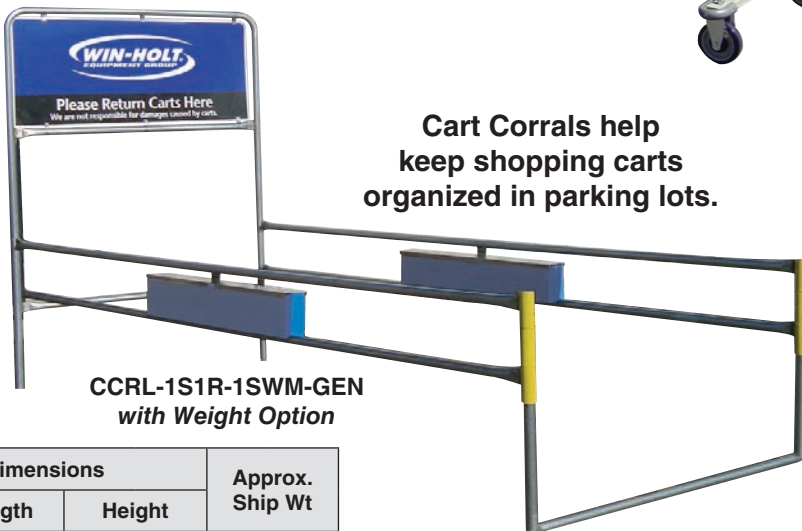

Cart Corrals help
keep shopping carts
organized in parking lots.

CCRL-1S1R-1SWM-GEN
with Weight Option

Model Number	Order#	Overall Dimensions						Approx. Ship Wt	
		Width		Length		Height		(lb)	(kg)
		(in)	(mm)	(in)	(mm)	(in)	(mm)		
CCRL-1S1R-1SWM-GEN	553289	72	1,829	168	4,267	96	2,438	180	81

Freight Class: 70



99MR/PO

Hand Trucks Steel

- Heavy duty steel pipe construction for tough jobs or standard duty steel tubular construction. Standard color is red.
- Heavy duty all welded reinforced plates - 8" depth x 14" width.
- Available with either 8" Mold-On Rubber or 10" Semi-Pneumatic wheels.

Model#	Order#	Overall Dimensions						Wheel Type (5/8" Ball Bearing)	Capacity		Approx. Ship Wt	
		Width		Length		Height			(lb)	(kg)	(lb)	(kg)
		(in)	(mm)	(in)	(mm)	(in)	(mm)					
Heavy Duty Steel Pipe Hand Trucks - 5 YEAR FRAME GUARANTEE												
508SP	133680	20	508	19	483	47	1,194	10" Semi-Pneumatic	800	363	32	15
Steel Tubular Hand Trucks - 3 YEAR FRAME GUARANTEE												
99MR	100870	20	508	19	483	49½	1,257	8" Mold-on Rubber	600	272	28	13
99SP	100888	20	508	19	483	49½	1,257	10" Semi-Pneumatic	600	272	34	15
Push-Off Steel Hand Trucks - 3 YEAR FRAME GUARANTEE												
99MR/PO	624956	20	508	19	483	49½	1,257	8" Mold-on Rubber	600	272	39	18

Caster Information

10" x 2¾" Semi-Pneumatic Wheel - (SP) 714 (128768)

8" x 1½" Mold-On Rubber Wheel - (MR) 715 (122665)

Freight Class: 150



99SP



508SP



308MR

Hand Trucks Magnesium

- 308 Series Frame constructed of heavy duty magnesium.
- The nose plate constructed of extra strong aluminum, offers a working surface of 8" depth and 14" width.
- Available with either 8" Mold-on Rubber or 10" Semi-Pneumatic wheels.

Model Number	Order#	Overall Dimensions						Wheel Type (5/8" Ball Bearing)	Capacity		Approx. Ship Wt	
		Width		Length		Height			(lb)	(kg)	(lb)	(kg)
		(in)	(mm)	(in)	(mm)	(in)	(mm)					
Heavy Duty Magnesium Hand Trucks - 3 YEAR FRAME GUARANTEE												
308MR	100853	18	457	18	457	50	1270	8" Mold-on Rubber	400	181	21	10
308SP	100861							10" Semi-Pneumatic			24	11

Caster Information

8" x 1½" Mold-On Rubber Wheel - (MR) 715 (122665)

10" x 2¾" Semi-Pneumatic Wheel - (SP) 714 (128768)

Freight Class: 150



ROLL CAGES & DISTRIBUTION CARTS



Folding Roll Cages
E-Commerce Picking Cart
Distribution Carts
Security Cages
Shelf Cart Aluminum



Folding Roll Cages

- Constructed of steel with a gray powder coated finish standard. We can customize the color to match any decor.
- Efficiently move product from distribution centers to stores to the selling floor.
- 3 & 4 sided roll cage, folds for storage conserving valuable floor space.
- Maneuvers easily on two 8" stationary center load wheels and four 6"x 2" phenolic swivel plate casters.
- Custom designs and additional sizes available upon request.

Caster Information
 Swivel Plate Caster with 5" Phenolic Wheel 73117 (591277)
 Swivel Plate Caster with 5" Phenolic Wheel & Brake 73117BK
Freight Class: 150

Custom designs and additional sizes available upon request.



STRC-4-7684-UKTC-B
 Shown with blue cage base and shelf, standard color is gray.

ST-3-SRC-8080-IW

Heavy Duty Phenolic Wheels



Model Number	Order#	Overall Dimensions						Capacity		Approx. Ship Wt	
		Width		Length		Height		(lb)	(kg)	(lb)	(kg)
		(in)	(mm)	(in)	(mm)	(in)	(mm)				
3 Sided Roll Cages											
ST-3-SRC-1110-IW	996881	43 ^{1/2}	1100	39 ^{3/8}	1000	71	1800	660	300	143	65
ST-3-SRC-8080-IW	996899	31 ^{1/2}	800	31 ^{1/2}	800	71	1800	660	300	110	50
4 Sided Roll Cage											
STRC-4-7684-UKTC-B	996872	30	760	33 ^{1/4}	846	73	1852	1325	600	154	70

E-commerce Picking Cart

Custom designs and additional sizes available. We can design a cart to fit your specific tote requirements - perfect to organize and process your e-commerce orders

- Light weight, aluminum cart, with container runners for picking, organizing and processing your e-commerce orders.
- Ideal in any distribution, e-commerce environment.
- Ergonomic design handles with hand grips for comfort.
- Corner bumpers protect associates, walls and fixtures, preventing work place injuries.
- Maneuvers easily on (4) 5" swivel stem casters with polyurethane wheels.



Lugs on page 129. Available in Gray, White, Red & Blue color code for priority processing.



Caster Information
 Swivel Plate Caster w/5" Polyurethane Wheel 738A (128784)
 5" Polyurethane Wheel 7112 (122180)
Freight Class: 250

Model Number	Order#	Overall Dimensions						Approx. Ship Wt	
		Width		Length		Height		(lb)	(kg)
		(in)	(mm)	(in)	(mm)	(in)	(mm)		
ST-DCT-9161-UT	998878	26 ^{1/2}	676	38	962	48	1214	61	28

Folding Distribution Carts

- Frame constructed of zinc plated steel with 3 stainless steel shelves
- Efficiently move product from distribution centers to stores to the selling floor.
- Folds for storage conserving valuable floor space.
- All Shelves fold up, unit nests for shipping and extra freight savings.
- Maneuvers easily on four 6"x 2" phenolic swivel plate casters.
- Custom designs and additional sizes available upon request.



DC-2538-EG



DC-2526-EG

Model Number	Order#	Overall Dimensions						Capacity		Approx. Ship Wt	
		Width		Length		Height		(lb)	(kg)	(lb)	(kg)
		(in)	(mm)	(in)	(mm)	(in)	(mm)				
DC-2538-EG	682478	24 ^{3/4}	629	38	965	67	1692	500	226	105	47
DC-2526-EG	651989	24 ^{3/4}	629	26	965	67	1692	500	226	105	47

Caster Information
Swivel Plate Caster with 5" Phenolic Wheel73117 (591277)
Freight Class: 150



Heavy duty Phenolic Wheels

Folding Distribution Carts

- Frame constructed of zinc plated steel with 2 stainless steel shelves
- Efficiently move product from distribution centers to stores to the selling floor.
- Folds for storage conserving valuable floor space.
- All Shelves fold up, unit nests for shipping and extra freight savings.
- Maneuvers easily on two 8" stationary center load wheels and four 5"x 2" phenolic swivel plate casters.
- Custom designs and additional sizes available upon request.



DC-2-2149/72H

Model Number	Order#	Overall Dimensions						Capacity		Approx. Ship Wt	
		Width		Length		Height		(lb)	(kg)	(lb)	(kg)
		(in)	(mm)	(in)	(mm)	(in)	(mm)				
DC-2-2149/72H	669855	21	533	47	1194	71 ^{3/4}	1822	1000	453	135	61

Caster Information
Swivel Plate Caster with 5" Phenolic Wheel73117 (591277)
Freight Class: 150



EC-2-3060-DEF

Security Cages

- Constructed steel, powder coated gray, with all steel mesh sides
- **See through mesh keeps merchandise visible at all times.**
- Two hinged doors with base and top locking mechanism with pad lock (sold separately) keeps merchandise secure.
- EC 2-3060-DEF, has two stationary shelves, with 22^{19/32}" between shelves.
- EC-3-3048-ADJ, has three shelves, two are adjustable on 1" increments with quick clips. Easily adjust the space between the shelves to accommodate a variety of merchandise. Also cage has a push a handle to assist with steering.
- Maneuvers easily on two 6" swivel plate casters and two 6" rigid plate casters, see wheel type below.

Model Number	Order#	Overall Dimensions						Capacity		Approx. Ship Wt	
		Width		Length		Height		(lb)	(kg)	(lb)	(kg)
		(in)	(mm)	(in)	(mm)	(in)	(mm)				
EC-2-3060-DEF	652703	60	1524	32	812	57	1448	2000	907	320	145
EC-3-3048/2ADJ	628615	48	1219	32	812	63	1600	2000	907	300	136

Caster Information EC-2-3060-DEF

Swivel Plate Caster w/ 6" x 2" Polyurethane 7326 (123131)
 Rigid Plate Caster w/ 6" x 2" Polyurethane Wheel 7417 (123351)
 6" x 2" Polyurethane Wheel 7129 (122446)

Freight Class: 250

Caster Information EC-3-3048/2ADJ

Swivel Plate Caster w/ 6" x 2" Phenolic Wheel & Brakes 7311BK (211115)
 Rigid Plate Caster w/ 6" x 2" Phenolic Wheel 746 (123481)
 6" x 2" Phenolic Wheel 7119 (122331)

Freight Class: 250



Phenolic Wheels on the EC-3-3048/2ADJ

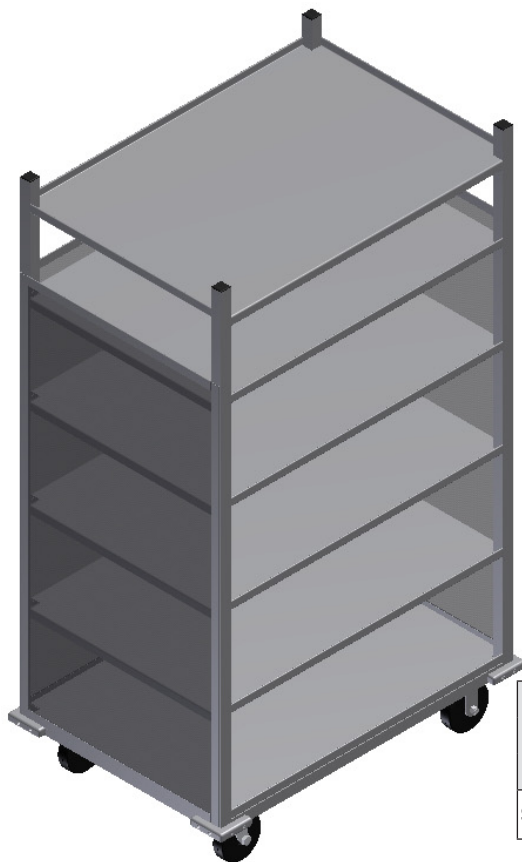

SC-6-2537M/E/AL

Shelf Cart, Aluminum

- Constructed of all welded aluminum with three aluminum enclosed mesh sides.
- Efficiently move product from distribution centers to stores to the selling floor.
- 5 shelves, with 11-1/4" spacing between shelves, the top shelf with 9-1/2". Middle and top shelf have lip up to prevent roll off.
- Maneuvers easily on two 5" swivel plate polyurethane casters and two 5" rigid plate polyurethane casters.
- Corner bumpers to protect walls and fixtures.

Model Number	Order#	Overall Dimensions						Capacity		Approx. Ship Wt	
		Width		Length		Height		(lb)	(kg)	(lb)	(kg)
		(in)	(mm)	(in)	(mm)	(in)	(mm)				
SC-6-2537M/E/AL	471970	27	686	38 ^{1/4}	972	65 ^{1/2}	1664	600	272	130	58

Caster Information

Swivel Plate Caster with 5" Polyurethane Wheel 738A (128784)
 Rigid Plate Caster with 5" Polyurethane Wheel 743A (128792)
 5" Polyurethane Wheel 7112 (122180)

Freight Class: 250

SMALLWARES & ACCESSORIES



Platters & Trays
Bagel Boards
Bagel, Bread and Bun Baskets
Bagel Scoop
Pizza Dough Boxes
Stainless Steel Trays
Lugs
Stack and Nest Containers
Merchandise Display Stand
Customer Shopping Baskets
Bakery Rack Covers
Cutting Boards & Replacement Poly Tops



WHP-1826WABS



AP-1826



WHP-1230



BB1826

Platters and Trays

- Constructed of injection molded, super hi-impact polystyrene with extra ribbing for rigidity and extra strength. Reinforced front and side edges provide additional impact resistance.
- Sanitary, safe edged, fingertip grip design. All smooth surfaces for easy cleaning.
- We offer three materials, all with reinforced front and side edges.
- Seamless construction of sanitary, white polystyrene resists the corrosive attacks of food and meat acids, strong detergents and temperature changes.

Model#	Order#	Overall Dimensions						Color	Approx. Ship Wt	
		Width		Length		Height			(lb)	(kg)
		(in)	(mm)	(in)	(mm)	(in)	(mm)			
WHP-1826WH	111843	18	457	26	660	1	25	White	3.5	16
WHP-1826WABS	111835	18	457	26	660	1	25	White	3	13
WHP-1826GABS	111819	18	457	26	660	1	25	Green	3	13
AP-1826	107991	18	457	26	660	1	25	Aluminum	3	1

Freight Class: 85

Items highlighted in red are Express Ship!
See page 148 for details.



Sani-Platters

- Constructed of injection molded, super hi-impact polystyrene with extra ribbing for rigidity and extra strength. Reinforced front and side edges provide additional impact resistance.
- Seamless construction of sanitary, white polystyrene resists the corrosive attacks of food and meat acids, strong detergents and temperature changes.

Model#	Order#	Overall Dimensions						Approx. Ship Wt	
		Width		Length		Height		(lb)	(kg)
		(in)	(mm)	(in)	(mm)	(in)	(mm)		
WHP-1030	104117	10	254	30	762	3/4	19	2	1.5
WHP-1224	104125	12	305	24	610	3/4	19	2.4	1.1
WHP-1230	104141	12	305	30	762	3/4	19		

Freight Class: 85

Items highlighted in red are Express Ship!
See page 148 for details.



Bagel Boards

- Hi-impact polystyrene bagel boards.
- Perfect for proofing bagels.
- Heavy duty, easy to clean plastic. Will not rot or mildew.



Model#	Order#	Overall Dimensions						Approx. Ship Wt	
		Width		Length		Height		(lb)	(kg)
		(in)	(mm)	(in)	(mm)	(in)	(mm)		
BB1826	208021	18	457	26	660	5/16	8	4	2

Freight Class: 60

Items highlighted in red are Express Ship!
See page 148 for details.



UPS and the UPS brandmark are trademarks that are used with permission by the owner, United Parcel Service of America, Inc. All rights reserved.

Bagel, Bread, and Bun Baskets

- For displaying, storing, and transporting bulk baked goods.
- Heavy duty, nickel chrome wire.
- Allows customers to see full selection of bagels and rolls.

Model Number	Order#	Description	Overall Dimensions						Approx. Ship Wt	
			Width		Length		Height		(lb)	(kg)
			(in)	(mm)	(in)	(mm)	(in)	(mm)		
WBB1319	207677	Chrome Basket, Level Top	13¾	349	19¾	502	5¾	146	4	2
WBB1723	207685	Chrome Basket, Level Top	17¾	451	23¾	603	8	203	7	4
WSBB1118	207714	Chrome Basket, Slant Top	11	279	18½	457	8	203	4	2

WSBB1118



WBB1723

Freight Class: 85

Items highlighted in red are Express Ship!
See page 148 for details.



Bagel Scoop

- Sturdy wire construction
- Nickel chrome finish is attractive and sanitary.

Model Number	Ordering Number	Overall Dimensions				Approx. Ship Weight	
		Width		Length		(lb)	(kg)
		(in)	(mm)	(in)	(mm)		
WBS-1432	210534	14	355	32	812	8	4

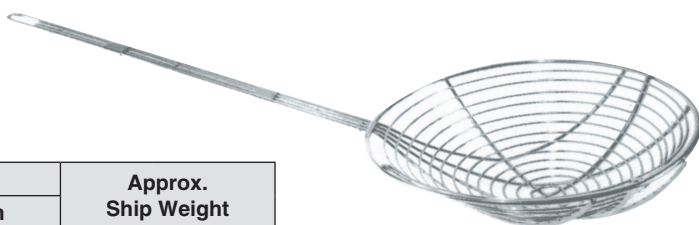

WBS-1432

Freight Class: 100

Items highlighted in red are Express Ship!
See page 148 for details.



Pizza Dough Boxes

- Ideal for pizza dough storage, prevents crusting and increases the life of the dough.
- Constructed of injection-molded, heavy duty ABS material.
- Reinforced front and side edges provide additional strength.

Model Number	Order Number	Overall Dimensions						Capacity	Approx. Ship Weight	
		Width		Length		Height			(lb)	(kg)
		(in)	(mm)	(in)	(mm)	(in)	(mm)	(gal)		
PD-18263	107983	18	457	26	660	3	76	4.5	4	2



PD-18263 Stacked

Freight Class: 85

Items highlighted in red are Express Ship!
See page 148 for details.



D-2027

In line with our policy to continually improve our products, Winholt reserves the right to change materials and specifications without notice.

See Aluminum Pizza Dough Box Dolly on page 75



Display Trays Stainless Steel

- Custom stainless steel display trays, are made to your display case specifications.
- Constructed of Stainless Steel, with hemmed edges for safety **Lifetime Warranty Against Rust**
- The trays make an attractive presentation in any display cabinet and are dishwasher safe.
- Ideal for service meat and fish departments. Reflective stainless steel surface highlights and features your fresh foods.
- Trays can also be ordered with handles.
- Available with or without drain holes.
- Perfect alternative to plastic, will retain its rich luster finish.

Stainless Steel Display Trays
Spotlight Your
Fresh Meat & Fish!



Custom Stainless Steel Drying and Storage Racks creates the perfect cleaning system. Built to fit your custom trays.

Model#	Order#	Overall Dimensions						Approx. Ship Wt		
		Width		Length		Height		(lb)	(kg)	
		(in)	(mm)	(in)	(mm)	(in)	(mm)			
Trays with 4 drain holes										
WHSSBX-615/2H/4DH	631662	6	152	15	381	2	51	3	1.36	
WHSSBX-815/2H/4DH	631697	8	203	15	391	2	51	3.5	15	
WHSSBX-630/1H/4DH	631646	6	152	30	762	1	25	4	18	
WHSSBX-630/2H/4DH	631654	6	152	30	762	2	51	5	2.25	
WHSSBX-830/1H/4DH	631671	8	203	30	762	1	25	5	2.25	
WHSSBX-1030/1H/4DH	631700	10	254	30	762	1	25	6	2.75	
WHSSBX-830/2H/4DH	631689	8	203	30	762	2	51	6.25	2.8	
Trays with no drain holes										
WHSSBX-615/2H	625561	6	152	15	381	2	51	3	1.36	
WHSSBX-815/2H	625596	8	203	15	391	2	51	3.5	15	
WHSSBX-1015/2H	625625	10	254	15	381	2	51	4	18	
WHSSBX-630/1H	625545	6	152	30	762	1	25	4	18	
WHSSBX-630/2H	625553	6	152	30	762	2	51	5	2.25	
WHSSBX-830/1H	625570	6	152	30	762	1	25	5	2.25	
WHSSBX-1030/1H	625609	10	254	30	762	1	25	6	2.75	

Freight Class: 100



Built to your specifications
Call for a quote today!



Lugs

- Ideal for transporting and storing all types of products including warm or cold, food processing, preparation, etc. Compatible with other brands.
- High density, polyethylene lugs will not rust or dent. USDA approved material. Smooth interior and wide radius corners for easy cleaning. Built-in handles.
- 1.3 cu. ft. capacity holds up to 100 lb (45 kg).
- 4:1 nesting ratio saves space and reduces handling of empties. Lugs designed to prevent jamming.
- Available in Gray, White, Red and Blue.

Model Number	Order Number	Overall Dimensions						Color	Approx. Ship Wt	
		Width		Length		Height			(lb)	(kg)
		(in)	(mm)	(in)	(mm)	(in)	(mm)			
Lug – Polyethylene										
WHPL-8GY	104432	16	406	25	635	8	203	Gray	3	2
WHPL-8WH	104459	16	406	25	635	8	203	White	3	2
WHPL-8RD-RC	643225	16	406	25	635	8	203	Red	3	2
WHPL-8BL-RC	643233	16	406	25	635	8	203	Blue	3	2
Lids – Polyethylene										
WHPL-8LID-GY	138608	16	406	25	635	1	25	Gray	3	2
WHPL-8LID-WH	128979	16	406	25	635	1	25	White	3	2

Freight Class: 70



AL-L-1

See line of Lug Carts on page 94



Items highlighted in red are Express Ship! See page 148 for details.



WHPL-8GY & WHPL-8LID-GY



Stack and Nest Containers

- Designed for a long life of rugged use, the Stack and Nest Container improves efficiency and productivity in any department.
- The uniform thickness and design gives maximum strength and protection to your goods. Built-in rim handles and a polyethylene material makes this product easy to handle. USDA approved material.

Model Number	Order Number	Overall Dimensions						Approx. Ship Wt	
		Width		Length		Height		(lb)	(kg)
		(in)	(mm)	(in)	(mm)	(in)	(mm)		
Lug – Gray Polyethylene									
SN-2618	104424	19	476	26	667	11	267	7	3
Lid – Gray Polyethylene									
LID-2618	104416	19	476	27	686	1	25	2	0.9

Freight Class:70



See companion dolly on page 76



SN-2618 Stacked



SN-2618 & LID-2618





Merchandise Display Stands Double & Single

- Material: All welded, plated, heavy duty, steel wire
- Maximizes product visibility and enhances customer impulse buying.
- Elevates products off the ground allowing the area underneath to be cleaned for more sanitary conditions.
- Nests for storage and freight savings.

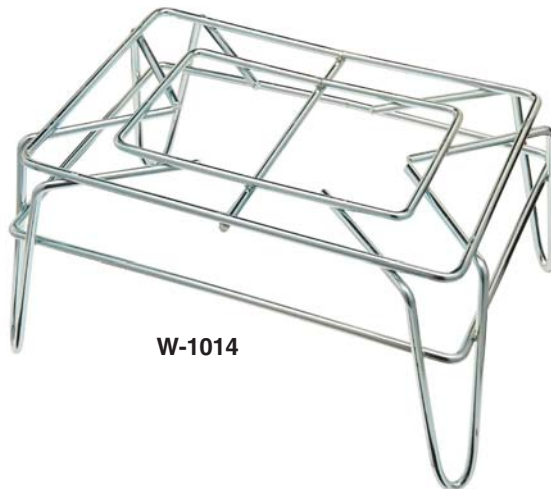

W-1014

Highlights products and merchandise in aisle.

Multiple units can be used the length of the aisle to increase impulse sales.

Model Number	Order#	Overall Dimensions						Capacity		Approx. Ship Wt	
		Width		Length		Height					
		(in)	(mm)	(in)	(mm)	(in)	(mm)	(lb)	(kg)	(lb)	(kg)
W-1014	108231	10	254	14	356	8	203	500	227	5	2
W-2414	624366	14	356	24	610	8	203	850	386	8	4

Freight Class: 125

Items highlighted in red are Express Ship!
See page 148 for details.

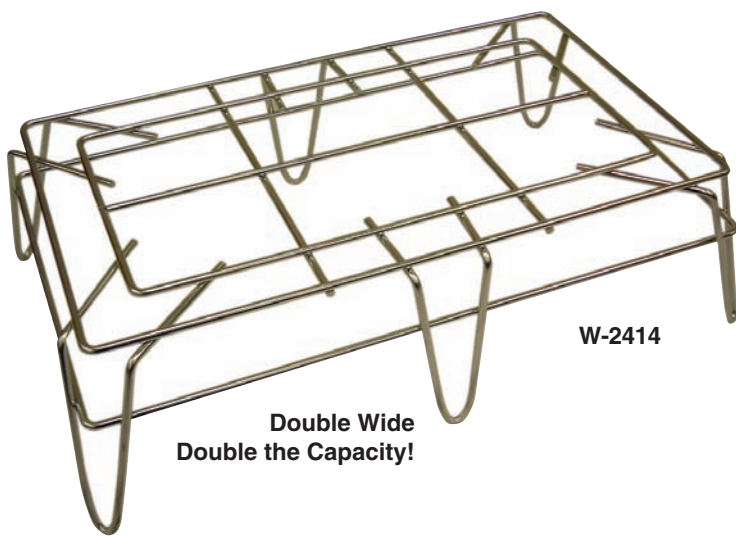

W-2414

**Double Wide
Double the Capacity!**

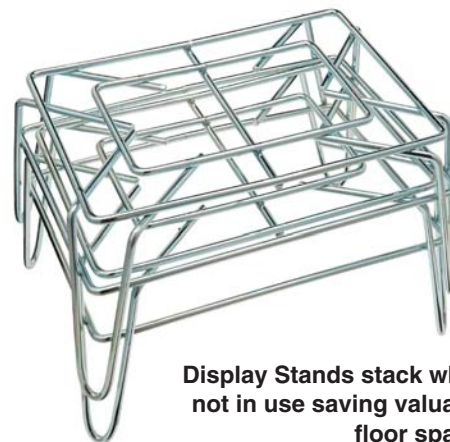

Display Stands stack when not in use saving valuable floor space!

UPS and the UPS brandmark are trademarks that are used with permission by the owner, United Parcel Service of America, Inc. All rights reserved.

Customer Shopping Baskets

- Great for Deli's, C-Stores, Supermarkets and Retail operations for customer convenience.
- Heavy duty, durable, washable polyethylene. Constructed with reinforced ribbing for strength and steel plated wire handles that are stronger than plastic.
- The cushioned grips offer comfort while carrying the baskets.
- Five bright colors to choose from complement your store decor.

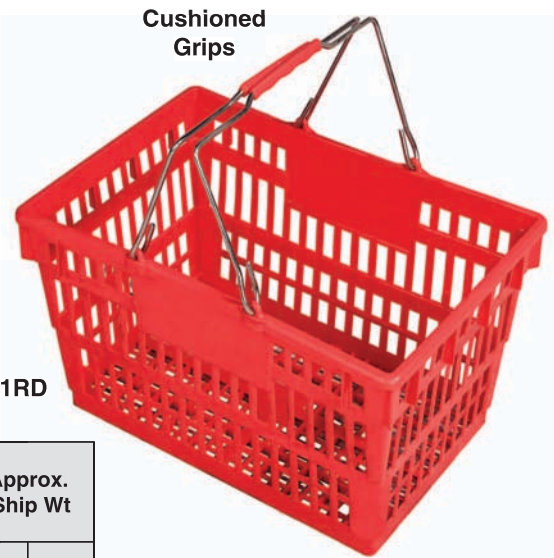

LSB-1RD

Model Number	Order Number	Item / Color	Overall Dimensions						Approx. Ship Wt	
			Width		Length		Height		(lb)	(kg)
			(in)	(mm)	(in)	(mm)	(in)	(mm)		
Super Sani-Baskets										
LSB-1RD	108062	Red (RD)	13	330	19	483	10	254	2.5	1
LSB-1BL	108038	Blue (BL)	13	330	19	483	10	254	2.5	1
LSB-1GR	108046	Green (GR)	13	330	19	483	10	254	2.5	1
LSB-1YW	108071	Yellow (YW)	13	330	19	483	10	254	2.5	1
LSB-1BK	129218	Black (BK)	13	330	19	483	10	254	2.5	1
Steel Stand										
LSB-STD	126800	Stand	13	330	19	483	43	1,092	4	2
Kit includes 12 Baskets, Stand										
LSB-KIT-RD	129373	Kit with 12 Red Baskets / Stand							35	16
LSB-DIE	162261	Logo Die	Minimum quantities apply, contact our Customer Care Department							
LSB-IMP	129234	Logo imprint -7" x 3" area								

Freight Class:85

To Order Kits:

Order LSB-KIT with the desired color abbreviation from the list above. Example LSB-KIT-BL for kit with blue baskets.



LSB-1RD with LSB-STD



Vinyl Coated Wire Case Dividers

- Versatile design allows you to create a high or low display. Heavy duty, vinyl coated Wire Dividers won't rust and are easy to clean.
- **Standard color is White, other colors available upon request, minimum quantities apply.**

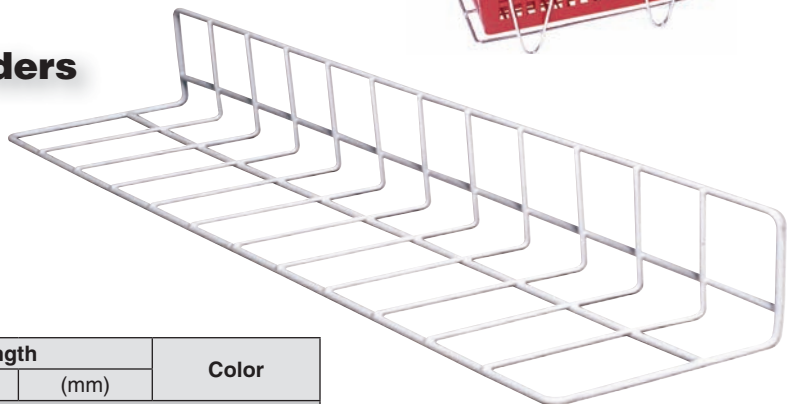

DIV-24128-EP

Model Number	Ordering Number	Length		Color
		(in)	(mm)	
Vinyl Wire Dividers with 8" (203 mm) and 12" (305 mm) Sides- For High Display				
DIV-24128-EP	109680	24	610	White
DIV-30128-EP	108484	30	762	White

Freight Class: 70





SRC-58/3Z

Bakery Rack Covers

- SRC-583Z is made of heavy duty, clear plastic cover with 3 reinforced zippers. Transparent plastic makes it easy to identify products.
- Protects products during transport while preserving freshness. Retards dehydration and enhances proofing.

Freezer Rack Covers

- SRC-58FC/3Z heavy duty, reinforced blue vinyl to withstand freezer temperatures down to -20°F; with 3 reinforced zippers. Transparent plastic front panel makes it easy to identify products.
- Protects products during transport while preserving freshness. Retards dehydration and enhances proofing.



SRC-58FC/3Z

Model Number	Order Number	Overall Dimensions						Approx. Ship Wt	
		Width		Length		Height		(lb)	(kg)
		(in)	(mm)	(in)	(mm)	(in)	(mm)		
SRC-58 / 3Z	112483	23	584	28	711	61	1,600	3	1
SRC-58FC / 3Z	157041					64	1,626	5	2

Freight Class: 77.5



Poly Top

Boards may not exceed 50 lb. or 36" in length or width.

Cutting Boards & Replacement Poly Tops

- Sanitary, 3/4*132" and 5/8" thick replacement poly tops and poly cutting boards are dishwasher safe and high-temperature safe to 180° F and may be steam cleaned without concern about cracking or warping. Poly will not chip, peel nor dull knives. All poly top cutting boards and table tops are NSF listed and USDA approved for contact for any type of food.
- Special order sizes and thicknesses available upon request.

Model Number	Order Number	Overall Dimensions				Approx. Ship Wt	
		Width		Length		(lb)	(kg)
		(in)	(mm)	(in)	(mm)		
Poly Top - 5/8" (16mm) Thickness							
PT58-1218	253446	12	304	18	457	4	2
PT58-1520	250026	15	381	20	508	6	3
Poly Top - 3/4" (19mm) Thickness							
PT34-1218	192268	12	304	18	457	6	3
PT34-1520	253471	15	381	20	508	12	5
PT34-1836	146157	18	457	36	914	11	5
PT34-2430	127706	24	609	30	762	21	10
PT34-3036	146018	30	762	36	914	28	12

Freight Class: 70

Option

311-033 (218544) Stainless Steel Clips for Poly tops



LOCKERS & RECEIVING DESKS

Associate Lockers
Locker Accessories
Steel Receiving Desks
Stainless Steel Receiving Desks





Steel Lockers

- Multi-User Steel Lockers can be used in all types of facilities, and industries, perfect for any environment.
- All Lockers open with door pulls and will accept padlocks (not included) for Positive Latching. Also can be used with flat key lock (not included).
- Doors are mesh grid vented. For clear identification of personal items and security.
- All lockers have a replaceable box base attached at the factory. Bases prevent dirt, dust and debris from accumulating under the lockers keeping the locker area clean and reducing labor costs.
- Shipped fully assembled, ready to use upon arrival.
- Beige finish.
- Sequentially numbered labels provided for easy identification.

Combination
Locks sold
separately see
page 137



WL-618
3 Column
18 Doors



WL-21
1 Column
2 Doors

2 Door Lockers

- Double-Tier Steel lockers double the number of compartments in the same amount of floor space, yet still allows for outer wear.
- Each Double column is equipped with a ceiling double-prong hook and 2 two side prong hooks.
- 3 Column sets are pre-attached, fully assembled.
- Beige finish.
- Sequentially numbered labels provided for easy identification.

Model Number	Order#	Number Doors	Dimensions						Approx Ship Wt	
			Width		Depth		Height		(lb)	(kg)
			(in)	(mm)	(in)	(mm)	(in)	(mm)		
2 Door, 1 Column										
WL-21	156216	2	12	305	15	381	78	1981	52	24
WL-21/15	163846	2	12	305	15	381	78	1981	97	44
2 Door, 3 Column										
WL-6	152864	6	36	914	12	381	78	1981	156	71
WL-6/15	163942	6	36	914	15	381	78	1981	160	73

Freight Class: 125

5 Door Lockers Multi-Tier

- Steel single column lockers offer 5 door compartments.
- 12" deep lockers standard and perforated doors.
- Enclosed base
- Shipped fully assembled. Ready to use upon arrival.
- Beige finish.
- Sequentially numbered labels provided for easy identification

Model Number	Order#	Number Doors	Dimensions						Approx Ship Wt	
			Width		Depth		Height		(lb)	(kg)
			(in)	(mm)	(in)	(mm)	(in)	(mm)		
5 Door, 1 Column										
WL-55	626433	5	12	305	12	305	66	1676	49	22

Freight Class: 125

Items highlighted in red are Express Ship! See page 148 for details.



WL-55
1 Column
5 Doors

6 Door Lockers Multi-Tier

- Steel single column lockers offer 6 door compartments.
- 3 column sets are pre-attached, fully assembled, 18 door compartments
- Available in 12", 15", and 18" depths.
- Beige finish.
- Sequentially numbered labels provided for easy identification.

Model Number	Order#	Number Doors	Dimensions						Approx Ship Wt	
			Width		Depth		Height		(lb)	(kg)
			(in)	(mm)	(in)	(mm)	(in)	(mm)		
6 Door, 1 Column										
WL-66	156195	6	12	305	12	305	78	1981	63	29
WL-66/15	163862	6	12	305	15	381	78	1981	69	31
WL-66/18	163918	6	12	305	18	457	78	1981	71	32
6 Door, 3 Column										
WL-618	130358	18	36	914	12	305	78	1981	190	86
WL-618/15	163854	18	36	914	15	381	78	1981	211	96
WL-618/18	163900	18	36	914	18	457	78	1981	234	108

Freight Class: 125

Items highlighted in red are Express Ship! See page 148 for details.



WL-618
3 Column
18 Doors



In line with our policy to continually improve our products, Winholt reserves the right to change materials and specifications without notice.

4 Door Lockers Horizontal Wall Mount



WL-4
4 Doors with Garment Bar

Garment bar provides Coat Storage

- Provides both coat storage and personal storage.
- Wall mounted steel locker provides personal storage for 4.
- Garment bar provides additional bottom coat storage.
- Shipped fully assembled, ready to use upon arrival.
- Beige finish.
- Sequentially numbered labels provided for easy identification.

Model Number	Order#	Number Doors	Dimensions						Approx Ship Wt	
			Width		Depth		Height		(lb)	(kg)
			(in)	(mm)	(in)	(mm)	(in)	(mm)		
4 Door, Horizontal Wall Mount Locker										
WL-4	156099	4	48	1219	18	457	13 5/8	346	40	18

Freight Class: 175



Garment bar provides Coat Storage

WL-16/CB WL-16/CB
16 Door

Garment/16 Person Locker

- Provides both coat storage and personal storage.
- Steel garment locker provides personal storage for 16.
- Garment bar provides additional bottom coat storage.
- Shipped fully assembled, ready to use upon arrival.
- Beige finish.
- Sequentially numbered labels provided for easy identification.

Combination Locks sold separately see page 137



Model Number	Order#	# Doors	Dimensions						Approx Ship Wt	
			Width		Depth		Height		(lb)	(kg)
			(in)	(mm)	(in)	(mm)	(in)	(mm)		
WL-16/CB	138253	16	72	1828	18	457	78	1981	193	88

Freight Class: 175

Locker Accessories

Boxed Bases

- In the event that bases are damaged by floor polishers or other equipment, they can be replaced without the expense of replacing the entire locker.
- Order one base for each column.

Model Number	Order Number	Description
WL-BB12	324216	Replacement Box Base For 12" Depth
WL-BB15	324224	Replacement Box Base For 15" Depth
WL-BB18	324232	Replacement Box Base For 18" Depth

Freight Class: 100



Enclosed Box Base

Slope Top Crown Kit - 3 Column

- Maintains clean locker tops to meet sanitary health codes.
- Easy to install. For factory installation please contact our Customer Care Department.

Model Number	Order#	Item Description	Depth		Weight	
			(in)	(mm)	(lb)	(kg)
WLST-12	162376	Fits 3 Columns Wide. Includes: 3 Slope Tops, 3 Back Supports, 2 End Pieces	12	305	5	2
WLST-15	165681		15	381	15	7
WLST-18	162384		18	457	20	9

Freight Class: 100



Maintains clean locker tops to meet sanitary health codes.

Combination Locks

- Remember to order Combination Lock with your locker orders!
- Master locks with black dial face.

Model Number	Order Number	Description
MSLCK-1	520487	Combo Lock

Other color are available upon request. Minimum quantities do apply, please contact our Customer Care Department.



MSLCK-1

Locker Numbering

- Locker number labels are supplied one-up, consecutively. The first locker is numbered at the factory and the other number tags are shipped inside that locker. Special numbering sequences are available at no extra charge. Include the required numbering with your order.
- Use Order Number: 654784 for custom numbering sequence.



Custom locker numbering
654784



OTE-78

Receiving/Shop Desks Steel

- All welded steel construction for extra strength.
- OT-78 Open frame with slanted writing surface and two undershelves. Standard color is beige.
- OTE-78 Enclosed solid sides and back with lockable doors. Slanted writing surface, with these storage shelves. Standard color is beige.
- OTE-2224-GY Expanded metal enclosed sides and back with lockable expanded metal door and two storage shelves. Lockable desk top with open paper compartments above the locking writing surface
- Other colors available, upon request.

Model Number	Order Number	Color	Overall Dimensions						Capacity		Approx. Ship Wt	
			Width		Length		Height		(in)	(mm)	(lb)	(kg)
			(in)	(mm)	(in)	(mm)	(in)	(mm)				
OT-78	101240	Beige	24	610	18	457	44	1,245	300	136	50	23
OTE-78	101282		65	29								
OTE-2224-GY	151968	Gray	22	559	22	610	49½	1,257			95	43



OTE-2224-GY

Caster Information

Swivel Square Stem Caster with 5" Polyurethane Wheel 757 (123684)
 Swivel Square Stem Caster with 5" Polyurethane Wheel & Brake 757BK (206931)
 5" Polyurethane Wheel 7112 (122180)

Freight Class: 125

Option

Specify option by adding suffix to Model Numbers.
 /HSP Hasp For OTE-78 & OTE-2224-GY



OT-78

Receiving/Shop Desks Steel & Wire Mesh

- Perfect choice for today's security conscious environment.
- Wire mesh locking cabinet enables visual inspection of contents.
- Unit has desk surface which lifts up into a lockable storage compartment.
- Gray finish.



OTE-2227E1-GY

Model Number	Order Number	Color	Overall Dimensions						Approx. Ship Wt	
			Width		Length		Height		(lb)	(kg)
			(in)	(mm)	(in)	(mm)	(in)	(mm)		
OTE-2227E1-GY	244081	Gray	27	686	22½	572	49	1,245	89	40

Caster Information

Swivel Square Stem Caster with 5" Polyurethane Wheel 757 (123684)
 Swivel Square Stem Caster with 5" Polyurethane Wheel & Brake 757BK (206931)
 5" Polyurethane Wheel 7112 (122180)

Freight Class: 125

Receiving Desks Steel

- Winholt Receiving Desks provide the perfect work station.
- All models are ideally suited for receiving and shipping areas.
- Each model provides a large, solid writing surface with pencil and paper compartments.
- Table units offer a convenient undershelf.
- Choose from Wall Mount, Mobile or Stationary designs.
- Constructed of heavy duty steel. Mobile units roll easy on (4) 5" heavy duty polyurethane swivel casters, two with brakes.



RDWN-1
Wall Mount



RDSWN-2
Stationary

Model Number	Order#	Type	Overall Dimensions						Approx. Ship Wt	
			Width		Length		Height		(lb)	(kg)
			(in)	(mm)	(in)	(mm)	(in)	(mm)		
RDWN-1	101371	Wall Mount	22	572	24	610	12	305	30	14
RDSWN-2	101362	Stationary	22	572	24	610	45	1,143	38	17
RDMWN-3	101354	Mobile	22	572	24	610	49	1,245	57	26
RDSWN-4	130180	Stationary					50	1,270	70	32
RDSWN-5	129066	Enclosed Stationary	32½	846	30	762	53	1,346	78	35



Caster Information - Use on RDMWN-3

Swivel Square Stem Caster with 5" Polyurethane Wheel 757 (123684)

Swivel Square Stem Caster with 5" Polyurethane Wheel & Brake 757BK (206931)

5" Polyurethane Wheel 7112 (122180)

Freight Class: 85 (RDWN-1)

Freight Class: 200

Option

472 (166641) Replacement Cylinder Lock & Key



Items highlighted in red are Express Ship!
See page 148 for details.



RDSWN-4
Stationary



RDSWN-5
Stationary Enclosed



RDMWN-3
Mobile

In line with our policy to continually improve our products, Winholt reserves the right to change materials and specifications without notice.



ups RDWNSS-1
Wall Mount

Receiving Desks Stainless Steel

- Ideal for food prep areas, receiving, record keeping and for inventory purposes.
- Constructed of all welded stainless steel.
- **Lifetime Warranty Against Rust.**
- Each model provides a large, solid writing surface with pencil and paper compartments.
- Table units offer a convenient undershelf.
- Choose from Wall Mount, Mobile or Stationary designs.
- Mobile units roll easy on four 5" heavy duty polyurethane swivel casters, two with brakes.



RDSWNSS-2
Stationary

Model Number	Order#	Type	Overall Dimensions						Approx. Ship Wt	
			Width		Length		Height		(lb)	(kg)
			(in)	(mm)	(in)	(mm)	(in)	(mm)		
RDWNSS-1	152830	Wall Mount	22	572	24	610	12	305	35	16
RDSWNSS-2	152848	Stationary	22	572	24	610	45	1,143	45	20
RDMWNSS-3	156081	Mobile	22	572	24	610	49	1,245	50	23
RDSWNSS-5	240688	Enclosed Stationary	32½	846	30	762	53	1,346	150	68

Caster Information - Use on RDMWNSS-3
 Swivel Square Stem Caster with 5" Polyurethane Wheel 757 (123684)
 Swivel Square Stem Caster with 5" Polyurethane Wheel & Brake 757BK (206931)
 5" Polyurethane Wheel 7112 (122180)
Freight Class: 85 (RDWNSS-1)
Freight Class: 200
 RDSWNSS-5 FOB-TX



RDMWNSS-3
Mobile



RDSWNSS-5
Stationary Enclosed

UPS and the UPS brandmark are trademarks that are used with permission by the owner, United Parcel Service of America, Inc. All rights reserved.

REPLACEMENT PARTS & WHEELS



Film Wrapper Parts
Heater Proofer Parts
Wheels & Casters



Thermostat



Thermostat Knob



Circuit Board

Film Wrapping Machine Replacement Parts

100% Pre-Tested!

Winholt offers a complete line of high quality replacement parts for all wrapper models. Our parts are fully compatible with other popular brands.



Cut-off Rod

Fuse Holder



Fuse



Lighted Rocker Switch

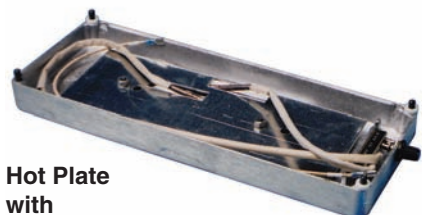

Hot Plate with Heating Element

Heating Element



Core Adapter/Wing Unit



Teflon Cover

Model Number	Ordering Number	Description of Parts	Dimensions
WHSS-CBD-A	695885	Circuit Board - E4 & E5 terminals for connecting wires	2½" x 2½"
WHSS-COR-A	687025	Cut-off Rod - Heats film to precise, necessary temperature	7/16" x 23"
WHSS-TM	113267	Thermostat - Regulates the heat for the Hot Plate	½" x ½" x 2¼"
WHSS-TK	113259	Thermostat Knob	¼" I.D.
WHSS-FUS1	113152	Fuse	9/32" x 1¼"
WHSS-FHD	113144	Fuse Holder	¼" x 1¼"
WHSS-HP6	113161	Hot Plate with Heating Element - Seals film securely	6" x 15"
WHSS-TC6	113232	Teflon Cover - For Hot Plate	6" x 15"
WHSS-E	113128	Heating Element - For Hot Plate	9/32" x 11¼"
WHSS-A	113056	Film Axle - Aluminum film core axle	¾" x 22"
WHSS-CAP	113081	Core Adapter Pin Unit	3" I.D. Roll
WHSS-CAW	113099	Core Adapter Wing Unit	3" I.D. Roll-Threaded
WHSS-RS	113224	Lighted Rocker Switch	1¼" x ½"
WHSS-BB	113072	Bearing Blocks - Regulates film tension	Bearing Blocks
WHSS-PR	135087	Plate Retainers - Holds element to hot plate	4" x 11-1/2"
WHSS-EWC	113136	Electric Wire	Per Foot

Freight Class:70

Electric Wire



Bearing Blocks



Film Axle

Express Ship. See Page 148 for details.



UPS and the UPS brandmark are trademarks that are used with permission by the owner, United Parcel Service of America, Inc. All rights reserved.

Heater Proofer Replacement Parts

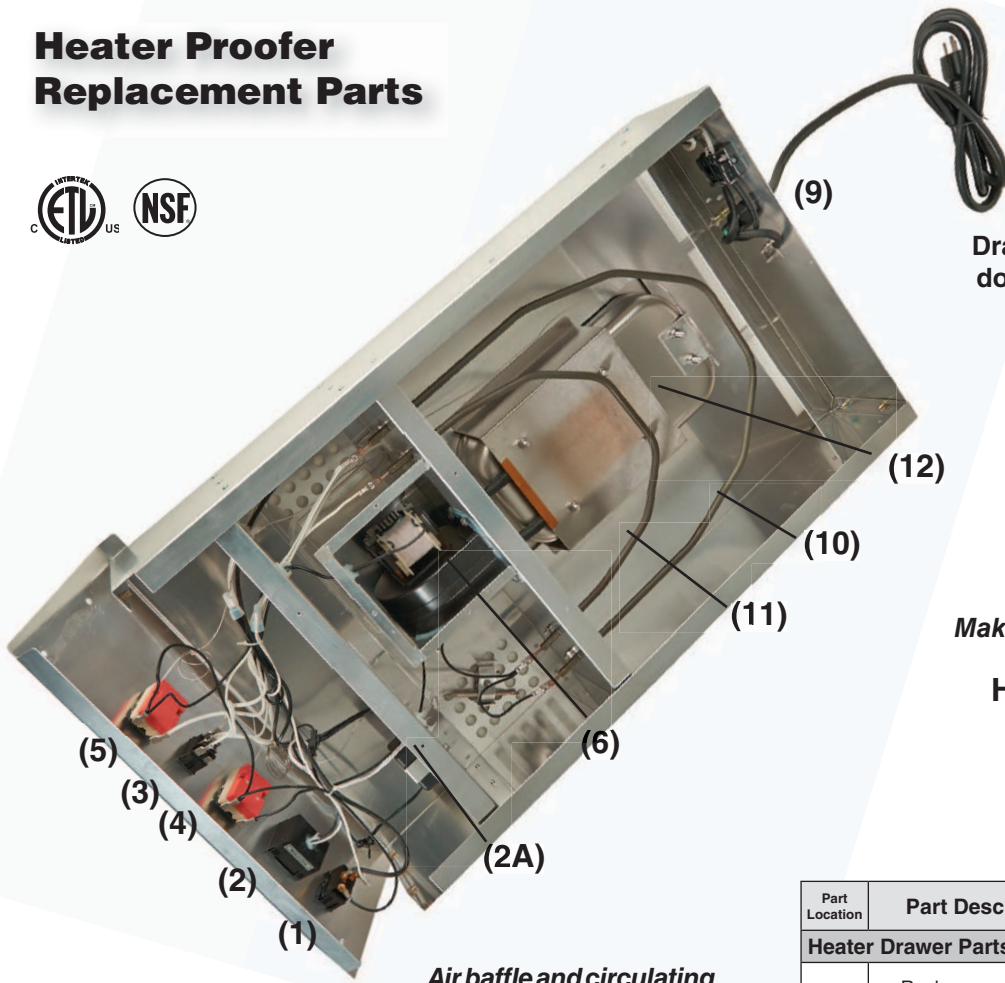

Drawer view from upside down with bottom cover removed.

NHP-PD-ECO
Removable Drawer
Makes Cleaning Quick & Easy

HEATER PROOFER
POWER SUPPLY
120VAC 60Hz
13.5 AMP

Air baffle and circulating air blower provide even heat distribution.

Water Pan (12A)



Part Location	Part Description	Order#	Model#
Heater Drawer Parts List			
—	Replacement Drawer	631208	NHP-PD-ECO
1	Main Power Switch	637108	H-106-2B
2	L.E.D. Thermometer	123887	H-105
2A	Thermometer Transformer		
3	Heat/Proof Switch	232784	H-106-1
9	Power Inlet	123908	H-107
4	Thermostat (Heat)	170851	H-220
5	Thermostat (Proof)		
6	Blower & Motor Assembly	637095	H-225-B
10	900W Heater Element	170907	H-226
11	600W Heater Element	170915	H-227
12	600W Water Pan Heater Element	170923	H-228
12A	Water Pan w/studs	696482	H-242
13	Heat Control Knob	123916	H-108
14	Proofer Control Knob		
---	External Drip Pan	683665	WHPP6122.5D
Replacement power cord available at local home improvement stores			
Cabinet Parts List			
	Replacement Door Lexan 1836 Series	247505	NHPL-DR
	Replacement Universal Runner (1)	657150	NHPL-1825-UN-RUNNER
	Door Gasket for NHPL-1810HHC	681416	NHPL-1810/HH-DR GSKT
	Door Gasket for NHPL-1825UNC	681328	NHPL1825-UN-DR GSKT
	Door Gasket for 1836 Series	650484	NHPL1836-DR GSKT



Express Ship.
See Page 148 for details.

Freight Class:70

Winholt Wheels & Casters

Wheel Terms

This diagram represents a basic wheel assembly. But this might vary from wheel to wheel. Please consult the wheel specifications.

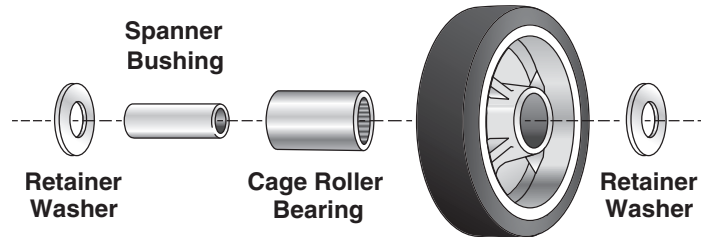

Caster Terms

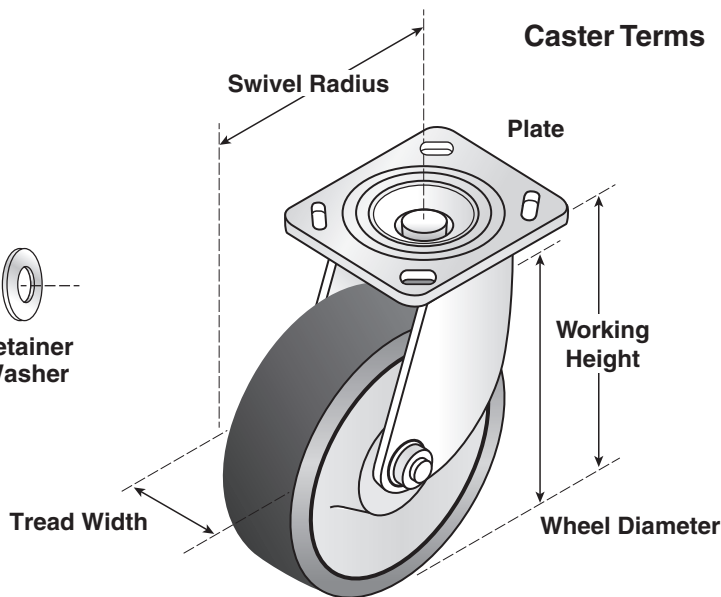

Choosing a Caster

Load Capacity - Load capacity can be described as the maximum rolling capacity of the equipment based on what you will place on that equipment. **Load capacity** per caster can be determined using this simple formula:

$$\text{Load Capacity} = \frac{(\text{Cart Weight} + \text{Maximum Load Placed on Cart})}{\text{Number of Casters on Cart}}$$

Example: 75 + 800 / 4 = 219 lbs per caster

We advise using your maximum load that might be used on the cart and not the average weight. The greater the weight the larger the wheel size should be to distribute the weight evenly. Always buy a caster with a higher rating than the load capacity formula. In our example of 219 lbs per caster you should go with a caster of at least 250 lbs. rolling capacity.

Proper maintenance and safety guidelines will extend the life and performance of your wheels. These easy to follow tips will assist you in achieving this goal.

1. Lubricate regularly, under normal conditions, approximately every six months. However, once a month may be warranted for applications in corrosive or wet conditions.
2. Check tread wear & swivel assemblies.
3. Do not roll at high speeds or on rough surfaces.
4. Do not exceed loads over the specified capacities.

Floor Surfaces										Easy Reference Wheel Selection Guide					Operating Conditions										
Carpet	Brick	Concrete	Linoleum	Asphalt	Terrazzo	Wood	Smooth Steel	Ribbed Steel	Tile	Wheel Type	Capacity of each		Temp Range	Durometer Ratings	Water	Steam	Mild Chemicals	Oil & Grease	Metal Chips	High Heat (+250°F)	Extreme Cold (-45°F)	Animal Fats	Noise Reduction	Floor Protection	Cushion Load
											(lb)	(kg)	(Fahrenheit)												
•	•	•	•	•	•	•	•	•	•	Polyurethane	150-1,000	68-454	-30° to +180°	95(±5)A	•	•	•	•	•	•	•	•	•	•	•
•	•	•	•	•	•	•	•	•	•	Solid Soft Rubber	75-400	34-181	-30° to +160°	75(±5)A	•	•	•	•	•	•	•	•	•	•	•
•	•	•	•	•	•	•	•	•	•	Solid Hard Rubber	100-500	45-227	-30° to +160°	75(±5)D	•	•	•	•	•	•	•	•	•	•	•
•	•	•	•	•	•	•	•	•	•	Polyolefin	100-850	45-385	-20° to +180°	65(±5)D	•	•	•	•	•	•	•	•	•	•	•
•	•	•	•	•	•	•	•	•	•	Mold-On Polyurethane	425-4,200	193-1,905	-30° to +180°	55(±5)D	•	•	•	•	•	•	•	•	•	•	•
•	•	•	•	•	•	•	•	•	•	Mold-On Rubber	200 / 1,700	91 / 771	-30° to +160°	75(±5)A	•	•	•	•	•	•	•	•	•	•	•
•	•	•	•	•	•	•	•	•	•	Phenolic	400 / 8,000	181 / 3,628	-45° to +250°	85(±5)D	•	•	•	•	•	•	•	•	•	•	•
•	•	•	•	•	•	•	•	•	•	Phenolic High Temp.	400 / 2,900	181 / 1,315	-45° to +475°	85(±5)D	•	•	•	•	•	•	•	•	•	•	•
•	•	•	•	•	•	•	•	•	•	Pneumatic	300-800	136 / 363	-20° to +160°	—	•	•	•	•	•	•	•	•	•	•	•
•	•	•	•	•	•	•	•	•	•	Semi-Pneumatic	150-450	68 / 204	-20° to +160°	—	•	•	•	•	•	•	•	•	•	•	•
•	•	•	•	•	•	•	•	•	•	Semi-Steel	200 / 3,000	91 / 1,361	-45° to +250°	—	•	•	•	•	•	•	•	•	•	•	•

Wheels



Polyurethane



Phenolic



Polyolefin



Mold-On Rubber

Plate Casters

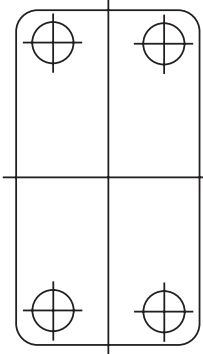

Wheel Dimensions	Material	Bearing	Wheel Model#	Swivel Caster Model#	Rigid Caster Model#	Rolling Cap Per Wheel	Temp Range	Hardness Rating
Plate Dimensions 3 1/8" x 4 1/8"								
3" x 1.25"	Rubber	Nylon	122171	7317	749	210 lbs.	-30 to +160	75(+/-5)D
3 1/4" x 1 1/2"	Polyurethane	Nylon		895529		210 lbs.	-30 to +180	95(+/-5)A
4" x 1.25"	Polyurethane	Ball	7125	7351	7418	275 lbs.	-30 to +180	95(+/-5)A
4" x 1.25"	Rubber	Nylon	716	732	742	225 lbs.	-30 to +160	75(+/-5)D
5" x 1.25"	Polyurethane	Ball	7112	738A	743A	400 lbs.	-30 to +180	95(+/-5)A
5" x 1.25"	Rubber	Nylon	718	738	743	200 lbs.	-30 to +160	75(+/-5)D
5" x 1.25"	Polyolefin	Plain	717	739	744	300 lbs.	-20 to +180	85(+/-5)D
Plate Dimensions 4" x 4 1/2"								
5" x 2"	Mold-On Rubber Polyurethane	Cage Roller	7123	7321CBZ	7451	1,000 lbs.	-30 to +180	55(+/-5)D
5" x 2"	Mold-On Rubber	Cage Roller	7113		745CBZ	375 lbs.	-30 to +160	75(+/-5)A
5" x 2"	Polyurethane	Cage Roller	7128	7318		250 lbs.	-30 to +180	95(+/-5)A
6" x 2"	Mold-On Rubber	Cage Roller	7115	7313	123502	1,200 lbs.	-30 to +180	55(+/-5)D
6" x 2"	Mold-On Rubber	Cage Roller	711	7324CBZ	7462	410 lbs.	-30 to +160	75(+/-)A
6" x 2"	Polyolefin	Cage Roller	7120	73111	7412	700 lbs.	-20 to +180	85(+/-5)D
6" x 2"	Phenolic	Cage Roller	7119	7311BK	746	1,200 lbs.	-45 to +250	85(+/-5)D
6" x 2"	Polyurethane	Cage Roller	7129			800 lbs.	-30 to +180	95(+/-5)A
8" x 2"	Mold-On Rubber	Cage Roller	7116	73161	7471	1,400 lbs.	-30 to +180	55(+/-5)D
8" x 2"	Mold-On Rubber	Cage Roller	712	7316	7411	500 lbs.	-30 to +160	75(+/-)A
8" x 2"	Phenolic	Cage Roller	7114			1,400 lbs.	-45 to +250	85(+/-5)D
8" x 2"	Polyurethane	Cage Roller	7130			900 lbs.	-30 to +180	95(+/-5)A

Freight Class:65



UPS and the UPS brandmark are trademarks that are used with permission by the owner, United Parcel Service of America, Inc. All rights reserved.

800.444.3595 | 516.921.0538 fax | www.winholt.com



Stem Casters

Square Stem
 27/32" x 2 1/2" with 13/64" or
 13/32" hole 1 1/4" above
 upper cup.



Round Stem
 3/16" x 1 9/16" with
 two cross drilled
 5/16" holes.

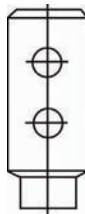

Wheel Dimensions	Wheel Material	Bearing	Wheel Model#	Swivel Stem Caster Model#	Rigid Stem Caster Model#	Rolling Cap Per Wheel	Temp Range	Hardness Rating
Round Stem								
5" x 1.25"	Polyurethane	Ball	71121	7548	7537	500 lbs.	-30 to +180	95(+/-5)A
Square 13/64 Stem								
5" x 1.25"	Polyurethane	Ball	7112	757		400 lbs.	-30 to +180	95(+/-5)A
5" x 1.25"	Rubber	Nylon	718	753		200 lbs.	-30 to +160	75(+/-5)D
5" x 1.25"	Polyolefin	Plain	717	751		300 lbs.	-20 to +180	85(+/-5)D
Grip Ring Stem								
4"	Superglide Thermo Plastic Rubber Wheel			750		110 lbs.	-30 to +160	75(+/-5)A
Threaded Stem								
5" x 1.25"	Polyurethane	Plain	71121	756		500 lbs.		

Oven Rack Casters - High Temp Phenolic Wheels

Molded macerated fabric with phenolic resin plastic. This hard tread wheel is designed for heavy load capacities and offers easy mobility over smooth surfaces and floor protection. The operation of the wheel is quieter than steel wheels and is resistant to most chemicals. **High Temp Wheels are ideal for oven racks!** Wheel includes bearing.



7322

Wheel Model#	Swivel Plate Caster Model#	Diameter		Tread Width		Bearing	Load Height		Swivel Radius		Capacity	
		(in)	(mm)	(in)	(mm)		(in)	(mm)	(in)	(mm)	(lb)	(kg)
Stainless Steel Caster												
71181	7322	4	102	1 1/2	32	Nylon	6 1/4	159	6	152	600	272

Caster Information
 Stainless Steel Rig 7322SS (342852)
Freight Class: 65

Hand Truck Wheels

- Model 714 is a semi-pneumatic solid rubber tire on a steel wheel disk. Maneuvers easily on all surfaces. Wheel includes bearing.
- Model 715 is a Mold-On Rubber tread locked to an aluminum core.



714

715

Wheel Model	Wheel Type	Diameter		Tread Width		Bearing	Axle Size		Hub Length		Cap.	
		(in)	(mm)	(in)	(mm)		(in)	(mm)	(in)	(mm)	(lb)	(kg)
715	Mold-On Rubber	8	203	1-5/8	41	Ball	5/8	16	2	51	450	204
714	Semi-Pneumatic	10	254	2 3/4	70				3	76		

Freight Class:65

ORDERING TERMS & WARRANTY

General Ordering Information
Conditions of Sale
Statement of Warranty
Care & Maintenance Tips



General Terms and Conditions of Sale

Acceptance: Orders become binding upon Winholt only when accepted by our Customer Care Department. Representative or dealer is not authorized to bind orders.

Orders accepted by Winholt cannot be cancelled without written approval and are subject to cancellation charges.

New Accounts: Please submit three (3) credit references, a bank reference with telephone number and contact person along with your Dun & Bradstreet number. We also require your Federal ID number or owners social security number and a copy of your Sales Tax Exemption Certificate wherever applicable. Allow three (3) to five (5) days to process your credit approval. For information concerning your credit status, please call the Credit Department at 516-222-0335.

Terms: Net thirty (30) days on open accounts from the date noted on the invoice. Open accounts will only be established upon receipt of satisfactory credit references.

Prices: All prices, specifications and discounts are subject to change without prior notice. Overall dimensions are as listed and these dimensions are nominal. The latest price list supercedes all other lists and any previously printed price materials. Prices are F.O.B. factory and do not include federal, state or other sales related taxes. Possession of the price list does not constitute an offer to sell. A freight surcharge may be imposed on shipments made out of our distribution centers.

Tax: Any tax or other governmental charge upon production, sale and/or shipment of goods, now imposed by federal, state or municipal authorities, or subsequently becoming effective, will be added to the price provided and will be paid by the buyer unless a completed and signed tax exemption certificate for appropriate state(s) is provided to Winholt.

Freight/Routing: Method of shipment will be determined by Winholt unless otherwise directed. When Winholt routes your order, as directed all units will ship at the standard freight class as determined by the carrier. The freight classes listed in the catalog are based upon the 2006 NMFC descriptions and are subject to interpretation and inspection, of which Winholt has limited control.

Damaged, Shortages and Lost Shipments: For shipments FOB Shipping point: Winholt will not be responsible for merchandise damaged in transit. All merchandise will be provided to carrier in good condition. All shipments should be inspected immediately upon receipt and any damage must be reported to the carrier at that time. For freight damage and loss in transit, it is the buyer's responsibility to file a freight claim against the carrier. Keep all concealed damaged goods and shipping containers for later inspection. For shipments FOB Destination: Winholt selected carrier service. All shipments must be inspected immediately upon receipt and any damaged merchandise must be noted on the POD and refused at time of delivery. All concealed damages and/or shortages must be reported to Winholt Customer Care Department within 48 hours of delivery. Winholt will not be responsible for any concealed damages or shortages not reported within 48 hours after delivery. All claims for damages and shortages noted on the POD will be processed by Winholt. Winholt reserves the right to request damaged merchandise to be returned to our facility for inspection prior to any credit being issued for the merchandise. Shortages: Shortage claims will not be considered unless Winholt Customer Care Department is notified within 48 hours after receipt of shipment.

Returns: To return merchandise, you must receive a Return Authorization Number from the Winholt Customer Care Department. Merchandise is to be returned with transportation charges pre-paid and is subject to a minimum 30% restocking fee. Any return product shipped FOB Shipping Point will be refused to the carrier and all returns without a Winholt RGA # notated on the shipper's paperwork will be refused to the carrier.

Customer Care Department: For information about our products, orders placed, or to place a new order, you may call our Customer Care Department toll free at 800.444.3595 between the hours of 8:00 a.m. and 5:00 p.m. CST, Monday thru Friday, Fax your order to 516.921.0538 or e-mail us at customerservice141@winholt.com.

Parts Service/Warranty Claims: For parts service information or warranty questions, please call our Customer Care Department toll free at 800.444.3595 between the hours of 8:00 a.m. and 5:00 p.m. CST, Monday thru Friday, Fax your inquiry to 516.921.0538 or e-mail us at customerservice141@winholt.com. Be sure you or your customer has the following information available when calling if applicable:

- o Model Number
- o Name of Dealer
- o Serial Number
- o Installation Date

How To Order: Call toll free: 800.444.3595 if you have questions, otherwise fax or e-mail your P.O. to:

- o Fax: 516.921.0538
- o e-mail: customerservice141@winholt.com

When placing an order, please provide us with complete information on your purchase order:

- o Purchase Order Number
- o Complete Bill To Address
- o Contact Name & Phone #
- o Winholt Payment Terms
- o Winholt Model# & Price
- o Desired Delivery Date
- o Specify Freight Carrier, if desired, on Collection or 3rd party shipments
- o Quotation Date and Number (if applicable)

(Note: If freight carrier is not specified, Winholt will specify.)

Minimum Orders: On all orders totaling less than \$250.00, there will be a \$25.00 processing charge added to the invoice.

Express Ship Program: Express items can ship within 5 business days subject to availability and quantity limits. Please call the Customer Care Department at 1-800-444-3595 or e-mail them at customerservice141@winholt.com for availability and quantity limits before placing an order. The Express Ship program is subject to terms and availability and Winholt reserves the right to remove or add items or discontinue the program at any time.

Bids & Quotations: Call 800.444.3595 and speak to a Winholt Sales Associate. Most quotations can be given at the time of call, the exception being large custom specifications which take between 24-48 hours. Quotations are valid for thirty (30) days from the date of quotation, unless otherwise noted on the quote.

Credit Card Purchases: For your convenience, we accept MasterCard & Visa.



In line with our policy to continually improve our products, Winholt reserves the right to change materials and specifications without notice.

Statement of Warranty

All Winholt equipment, aluminum, plastic, steel and stainless steel, is guaranteed to be free from defects in materials and workmanship for one (1) year from the date of shipment from the Winholt Facility.

The warranty does not apply to equipment, which has been subject to accident, alteration, abuse, misuse, improper installation, maintenance or storage and adverse weather conditions. It excludes WinFab™ Custom Stainless Steel Fabrication projects covered under separate warranty.

Maintenance Tips for Finishes

Powder Coating - Powder coated products are primarily intended for indoor use. Clean by using a non-petroleum based cleaner.

Chrome Plating - Chrome plated products are suitable for indoor use. Chrome should be cleaned with a domestic grade, chrome cleaner. If chrome does come in contact with water, wipe with a clean dry cloth immediately.

Zinc Coated & Galvanized Steel - In most cases these products can be used outside. To clean mix ¼ cup dish soap in a gallon of hot water. Using a soft bristled brush, scrub the metal surface with firm, circular strokes. Rinse this off thoroughly with hot water and then wipe it dry using a lint free rag cloth. Clean away hard water stains from galvanized metal surfaces using a solution of equal parts white distilled vinegar and water.

Extended Warranty on Aluminum and Stainless Steel

Winholt Equipment Group provides a lifetime guarantee against rust or corrosion on all aluminum and stainless steel products for the period of time that the original purchaser owns the product. This guarantee is in effect provided that the product is used solely for its intended purpose, is cleaned and maintained periodically within accepted industry standards, and is cleaned with a cleaning agent generally accepted by the industry and in accordance with the label directions of the cleaning agent used.

Stainless Steel Maintenance Tips

When cleaning stainless steel products, use non-abrasive tools. Soft cloths and plastic scouring pads will not harm steel's passive layer. Always clean in the same direction of the manufacturers' polishing marks. Use alkaline chlorinated or non-chloride containing cleaners.

Aluminum Maintenance Tips

When cleaning aluminum products, use acids and non-abrasive tools. A natural acid like lemon juice with a little salt on a wet rag will clean and restore the aluminum. Rub gently (as the salt is slightly abrasive).

Winholt Power Equipment Warranty

Winholt warrants to the initial purchaser that all Winholt power equipment, including but not limited to Heater Proofers and Film Wrappers be free from defects in material or factory workmanship, under ordinary use for the purpose for which it is designed, for a period of (1) year from the date of shipment from the Winholt facility. Equipment will at our option be repaired or replacement part(s) furnished F.O.B. our factory. Warranty includes one (1) year labor from date of said shipment.

Return of component parts will not be accepted for credit without prior authorization of our Customer Care Department and then contingent upon our inspection. Warranty will not apply if, after examination, Winholt finds that the equipment or any part thereof was found defective through lack of purchaser's responsibility for maintenance or storage, shipping damage, accidental damage by moving or otherwise, improper voltage, misapplication or alteration by anyone other than ourselves, or use of unauthorized parts. Warranty does not apply to glass, plastic, light bulbs, gaskets, or heater elements.

Prior to any service agency performing warranty labor, Winholt's Customer Care Department must be contacted to provide a "Service Authorization" (SA) number. Winholt assumes no responsibility for any charges that were not expressly authorized by it or for any charges that exceed in Winholt's sole judgement, normal and customary amounts. If service is required during overtime the difference between overtime and standard labor rates shall be paid by the purchaser. Warranty does not apply if payment has not been received for the equipment at the time a claim is made or if the Winholt serial number has been removed.

Warranty Exclusions and Limitations: Warranty applies only within the United States, equipment outside the United States shall have parts coverage only.

Administration of Warranty

For assistance in filing a claim, contact Winholt's Customer Care Department at 800.444.3595. Hablamos Español. All claims must be filed in writing and can be sent via: e-mail to customerservice141@winholt.com, faxed to 516-921-0538 or mailed to Winholt Equipment, 1169 North Great Southwest Parkway, Grand Prairie, Texas 75050, Attention: Customer Care Department. If deemed necessary by Winholt, the product must be returned to a Winholt factory designated by Winholt, at the owner's expense for inspection and approval of the claim.

This warranty supersedes any other warranties implied or expressed. Warranty will not apply if purchaser is delinquent in payment of the equipment at the time claim is made or if our serial number has been removed from the equipment. Except as herein above set forth no other warranty is made. This warranty being exclusive and in lieu of all other warranties, expressed, implied or statutory, including without limitation implied warranties of merchantability or fitness. In no event shall the Company be liable for any delay in the performance of this warranty due to causes beyond its control. The Company shall in no event be liable for any consequential; special or contingent damages for breach of warranty or otherwise.

INDEX BY MODEL NUMBER



Model Number	Order#	Product Description	Page#
ADE1812B/KDA	127440	Knock-Down Economy Pan Rack End Loading	48
ADE1820B/KDA	112168	Knock-Down Economy Pan Rack End Loading	48
ADJ	Option	Correctional Shelving Option Adjustable Feet	90
AL-1010	103851	Platter Cart, Aluminum	96
AL-1012	103860	Platter Cart, Aluminum	96
AL-106	103878	Half Size Platter Cart, Aluminum	96
AL-1210	103886	Platter Cart, Aluminum	96
AL-1212	103915	Platter Cart, Aluminum	96
AL-126	103931	Half Size Platter Cart, AL	96
AL-1806/H	206797	Bun Pan Rack, Half Size	51
AL-1806H/ALTOP	--	1/2 Size Pan Rack with removable AL Top	51
AL-1806H/SSTOP	--	1/2 Size Pan Rack with removable SS Top	51
AL-1807-IR-KD	626089	Insert Racks- 1/2 Size	53
AL-1810/H	206800	Bun Pan Rack, Half Size	51
AL-1810/HKD	209377	Knock-Down Heavy Duty Pan Rack, Half Height	48
AL-1810/H-PT	567488	1/2 Size Pan Rack with removable Poly Top	51
AL-1810B	109840	Heavy Duty Pan Rack, AL	49
AL-1810H/ALTOP	--	1/2 Size Pan Rack with removable AL Top	51
AL-1810H/SSTOP	537676	1/2 Size Pan Rack with removable SS Top	51
AL-1810N	267371	Nesting Pan Rack	56
AL-1812/HD	592536	XTRA Pan Rack	50
AL-1812B	109882	Heavy Duty Pan Rack, AL	49
AL-1815B	109938	Heavy Duty Pan Rack, AL	49
AL-1816-IR-KD	582928	Insert Rack- Full Size	53
AL-1818B	109989	Heavy Duty Pan Rack, AL	49
AL-1820/HD	592165	XTRA Pan Rack	50
AL-1820B	110023	Heavy Duty Pan Rack, AL	49
AL-1820B/XB	647024	Heavy Duty Pan Rack with Reinforced Sides	50
AL-1820BKD/HD	323459	Knock-Down Heavy Duty Pan Rack	48
AL-1820N	110066	Nesting Pan Rack	56
AL-1830/HD	592173	XTRA Pan Rack	50
AL-1830B	110120	Heavy Duty Pan Rack, AL	49
AL-186	103958	Half Size Platter Cart, AL	94
AL-2420/33D	667489	Donut Screen Rack	55
AL-2424B	110226	Donut Screen Rack	55
AL-2610B	110251	Heavy Duty Pan Rack, AL	49
AL-2612B	110269	Heavy Duty Pan Rack, AL	49
AL-2615B	110293	Heavy Duty Pan Rack, AL	49
AL-2618B	110322	Heavy Duty Pan Rack, AL	49
AL-2620B	110349	Heavy Duty Pan Rack, AL	49
AL-300-60-FH	661407	Folding U-Boat, AL	111
AL-3207CR/M	261892	Crisping Rack	97
ALB-48T	118527	WinFab Table Modification	38
ALB-48W	118543	WinFab Table Modification	38
ALB-60T	118551	WinFab Table Modification	38
ALB-60W	118560	WinFab Table Modification	38
ALB-72T	118594	WinFab Table Modification	38
ALB-72W	118615	WinFab Table Modification	38
ALB-96T	118666	WinFab Table Modification	38
ALB-96W	118674	WinFab Table Modification	38
ALC-1836	110648	Channel Pan Rack	54
ALC-1840	110672	Channel Pan Rack	54
ALD-1826	117897	WinFab Table Modification	38

Model Number	Order#	Product Description	Page#
ALDIV-1218	118691	WinFab Table Modification	38
AL-L-1	104176	Lug Cart, Capacity 1 Lug	94
AL-L-2	104230	Lug Cart, Capacity 2 Lug	94
AL-L-3	104264	Lug Cart, Capacity 3 Lug	94
AL-L-6	104281	Lug Cart, Capacity 6 Lug	94
ALMCH - SERIES	Optional Design	Mobile E-Channel Cooler Back Room Shelving	88
ALMCH-48-220	244486	Mobile E-Channel Cooler Back Room Shelving	89
ALMCH-48-320	244494	Mobile E-Channel Cooler BackRoom Shelving	89
ALMCS - SERIES	Optional Design	Mobile Tubular Cooler Back Room Shelving	88
ALMCS-36-424	180988	Mobile Tubular Cooler Back Room Shelving	89
ALMCS-48-320	102171	Mobile Tubular Cooler Back Room Shelving	89
ALMCS-48-324	102189	Mobile Tubular Cooler Back Room Shelving	89
ALMCS-60-224	661466	Mobile Tubular Cooler Back Room Shelving	89
ALMCS-60-320	186968	Mobile Tubular Cooler Back Room Shelving	89
ALMCS-60-324	132249	Mobile Tubular Cooler Back Room Shelving	89
ALMTB - SERIES	Optional Design	Mobile T-Bar Cooler Back Room Shelving	88
ALPH-1224	118869	WinFab Table Modification	38
ALREF-1118/64E	384956	Refrigerator Rack, Economy	53
ALREF-1818/64E	384981	Refrigerator Rack, Economy	53
ALSCH-36-320-CM	633334	Correctional Shelving - Channel	90
ALSCH-36-324-CM	633385	Correctional Shelving - Channel	90
ALSCH-36-420-CM	633553	Correctional Shelving - Channel	90
ALSCH-36-424-CM	633617	Correctional Shelving - Channel	90
ALSCH-42-320-CM	633342	Correctional Shelving - Channel	90
ALSCH-42-324-CM	633393	Correctional Shelving - Channel	90
ALSCH-42-420-CM	633561	Correctional Shelving - Channel	90
ALSCH-42-424-CM	633625	Correctional Shelving - Channel	90
ALSCH-48-220	206498	Correctional Shelving - Channel	88
ALSCH-48-224	206501	Correctional Shelving - Channel	88
ALSCH-48-320	206586	Correctional Shelving - Channel	88
ALSCH-48-320-CM	633351	Correctional Shelving - Channel	90
ALSCH-48-324	206594	Correctional Shelving - Channel	88
ALSCH-48-324-CM	633406	Correctional Shelving - Channel	90
ALSCH-48-420-CM	633570	Correctional Shelving - Channel	90
ALSCH-48-424-CM	633633	Correctional Shelving - Channel	90
ALSCH-52-320-CM	633369	Correctional Shelving - Channel	90
ALSCH-52-324-CM	633414	Correctional Shelving - Channel	90
ALSCH-52-420-CM	633588	Correctional Shelving - Channel	90

Model Number	Order#	Product Description	Page#
ALSCH-52-424-CM	633641	Correctional Shelving - Channel	90
ALSCH-60-220	206535	Cooler & Backroom Shelving - E-Channel	88
ALSCH-60-224	206543	Cooler & Backroom Shelving - E-Channel	88
ALSCH-60-320	206615	Cooler & Backroom Shelving - E-Channel	88
ALSCH-60-320-CM	633377	Correctional Mitered Edge Shelving - Channel	90
ALSCH-60-324	206623	Cooler & Backroom Shelving - E-Channel	88
ALSCH-60-324-CM	633422	Correctional Shelving - Channel	90
ALSCH-60-420-CM	633596	Correctional Shelving - Channel	90
ALSCH-60-424-CM	633650	Correctional Shelving - Channel	90
ALSCH-72-320-CM	634038	Correctional Shelving - Channel	90
ALSCH-72-324-CM	634046	Correctional Shelving - Channel	90
ALSCH-72-420-CM	634062	Correctional Shelving - Channel	90
ALSCH-72-424-CM	634071	Correctional Shelving - Channel	90
ALSCS-36-320	143511	Cooler & Backroom Shelving - Tubular Bar Style	88
ALSCS-36-320-CM	633191	Correctional Shelving - Tubular	90
ALSCS-36-324	143693	Cooler & Backroom Shelving - Tubular Bar Style	88
ALSCS-36-324-CM	631443	Correctional Shelving - Tubular	90
ALSCS-36-420-CM	633238	Correctional Shelving - Tubular	90
ALSCS-36-424-CM	633289	Correctional Shelving - Tubular	90
ALSCS-42-320-CM	633203	Correctional Shelving - Tubular	90
ALSCS-42-324-CM	631451	Correctional Shelving - Tubular	90
ALSCS-42-420-CM	633246	Correctional Shelving - Tubular	90
ALSCS-42-424-CM	633297	Correctional Shelving - Tubular	90
ALSCS-48-220	102269	Cooler & Backroom Shelving - Tubular Bar Style	88
ALSCS-48-224	102277	Cooler & Backroom Shelving - Tubular Bar Style	88
ALSCS-48-320	102285	Cooler & Backroom Shelving - Tubular Bar Style	88
ALSCS-48-320-CM	632091	Correctional Shelving - Tubular	90
ALSCS-48-324	102293	Correctional Shelving - Tubular	88
ALSCS-48-324-CM	631460	Correctional Shelving - Tubular	90
ALSCS-48-420-CM	633254	Correctional Shelving - Tubular	90
ALSCS-48-424-CM	633300	Correctional Shelving - Tubular	90
ALSCS-52-320-CM	633211	Correctional Shelving - Tubular	90
ALSCS-52-324-CM	631478	Correctional Shelving - Tubular	90
ALSCS-52-420-CM	633262	Correctional Shelving - Tubular	90
ALSCS-52-424-CM	633318	Correctional Shelving - Tubular	90

Model Number	Order#	Product Description	Page#
ALSCS-60-220	102314	Cooler & Backroom Shelving - Tubular Bar Style	88
ALSCS-60-224	102322	Cooler & Backroom Shelving - Tubular Bar Style	88
ALSCS-60-320	102331	Cooler & Backroom Shelving - Tubular Bar Style	88
ALSCS-60-320-CM	632104	Correctional Mitered Edge Shelving - Tubular	90
ALSCS-60-324	102349	Cooler & Backroom Shelving - Tubular Bar Style	88
ALSCS-60-324-CM	631486	Correctional Shelving - Tubular	90
ALSCS-60-420	102357	Cooler & Backroom Shelving - Tubular Bar Style	88
ALSCS-60-420-CM	633271	Correctional Shelving - Tubular	90
ALSCS-60-424-CM	633326	Correctional Shelving - Tubular	90
ALSCS-72-320-CM	633991	Correctional Shelving - Tubular	90
ALSCS-72-324-CM	634003	Correctional Shelving - Tubular	90
ALSCS-72-420-CM	634011	Correctional Shelving - Tubular	90
ALSCS-72-424-CM	634020	Correctional Shelving - Tubular	90
ALSPR-1320	157788	Steam Pan Rack	56
ALSPR-2212	382387	Steam Pan Rack	56
ALSPR-2220	382395	Steam Pan Rack	56
ALSPRD-1320	382424	Steam Pan Rack Double Wide	56
ALSQ-3-1220	102971	Heavy Duty Dunnage Rack	91
ALSQ-3-1224	102980	Heavy Duty Dunnage Rack	91
ALSQ-3-820	103034	Heavy Duty Dunnage Rack	91
ALSQ-3-824	103042	Heavy Duty Dunnage Rack	91
ALSQ-4-1220	103085	Heavy Duty Dunnage Rack	91
ALSQ-4-1224	103093	Heavy Duty Dunnage Rack	91
ALSQ-4-820	103181	Heavy Duty Dunnage Rack	91
ALSQ-4-824	103190	Heavy Duty Dunnage Rack	91
ALSQ-5-1220	103202	Heavy Duty Dunnage Rack	91
ALSQ-5-1224	103211	Heavy Duty Dunnage Rack	91
ALSQ-5-820	103245	Heavy Duty Dunnage Rack	91
ALSQ-5-824	103253	Heavy Duty Dunnage Rack	91
ALSTB-36-320-CM	633748	Correctional Shelving - T-Bar	90
ALSTB-36-324-CM	633799	Correctional Shelving - T-Bar	90
ALSTB-36-420-CM	633879	Correctional Shelving - T-Bar	90
ALSTB-36-424-CM	633924	Correctional Shelving - T-Bar	90
ALSTB-42-320-CM	633756	Correctional Shelving - T-Bar	90
ALSTB-42-324-CM	633801	Correctional Shelving - T-Bar	90
ALSTB-42-420-CM	633887	Correctional Shelving - T-Bar	90
ALSTB-42-424-CM	633932	Correctional Shelving - T-Bar	90
ALSTB-48-320	165112	Cooler & Backroom Shelving - T-Bar Style	90
ALSTB-48-320-CM	633764	Correctional Shelving - T-Bar	90
ALSTB-48-324	152979	Cooler & Backroom Shelving - T-Bar Style	88
ALSTB-48-324-CM	633810	Correctional Shelving - T-Bar	90
ALSTB-48-420-CM	633895	Correctional Shelving - T-Bar	90
ALSTB-48-424-CM	633941	Correctional Shelving - T-Bar	90
ALSTB-52-320-CM	633772	Correctional Shelving - T-Bar	90
ALSTB-52-324-CM	633828	Correctional Shelving - T-Bar	90
ALSTB-52-420-CM	633908	Correctional Shelving - T-Bar	90
ALSTB-52-424-CM	633959	Correctional Shelving - T-Bar	90
ALSTB-60-320	165104	Cooler & Backroom Shelving - T-Bar Style	88
ALSTB-60-320-CM	633781	Correctional Shelving - T-Bar	90

Model Number	Order#	Product Description	Page#
ALSTB-60-324	152987	Cooler & Backroom Shelving - T-Bar Style	88
ALSTB-60-324-CM	633836	Correctional Shelving - T-Bar	90
ALSTB-60-420-CM	633916	Correctional Shelving - T-Bar	90
ALSTB-60-424-CM	633967	Correctional Shelving - T-Bar	90
ALSTB-72-320-CM	634089	Correctional Shelving - T-Bar	90
ALSTB-72-324-CM	634097	Correctional Shelving - T-Bar	90
ALSTB-72-420-CM	634100	Correctional Shelving - T-Bar	90
ALSTB-72-424-CM	634118	Correctional Shelving - T-Bar	90
ALUC-2-2036/36H	624251	Aluminum Utility Cart	116
ALUC-2-2036-T	662549	Sani-Stock Cart, Tubular	117
ALUC-2-2048-T	663058	Sani-Stock Cart, Tubular	117
ALUN-1812/HD	592552	XTRA Universal Rack	52
ALUN-1820/HD	592544	XTRA Universal Rack	52
ALUN-Option Corner Bumper	Option	Option Corner Bumper for EXTRA HD Universal Rack	52
ALUN-Option Full Perimeter Bumper	Option	Option Perimeter Bumper EXTRA HD Universal Rack	52
ALUN-Option Prison Package	Option	Option Prison Package EXTRA HD Universal Rack	52
ALUN-Option Solid Base	Option	Option Solid Base for EXTRA HD Universal Rack	52
ALUN-Option Solid Top	Option	Option Solid Top for EXTRA HD Universal Rack	52
ALUN-Option Vertical Bumper	Option	Option Vertical Bumper EXTRA HD Universal Rack	52
ALWMS-1236	222498	Solid Wall Shelf	92
ALWMS-1248	118720	Solid Wall Shelf	92
ALWMS-1260	222455	Solid Wall Shelf	92
AP-1826	107991	Display Storage Tray	126
AS-48	151001	U-Boat removable shelf	111
AS-60	151010	U-Boat removable shelf	111
AVT-4-2637/PU	187961	Display Merchandisers	106
B	Option	Pan Rack Option Bumper	49
B-16	101418	Jumbo Bulk Mover	119
BB1826	208021	Bagel board	126
BFL	Option	Option Mop sink back flashing	15
BLC-1	101602	Bulk Movers 3 Bushel	93
BNQT-3	154325	Queen Mary Banquet Cart	70
BNQT-3/SS	232012	Queen Mary Banquet, SS	70
BNQT-4	127546	Queen Mary Banquet Cart	70
BNQT-4/SS	168997	Queen Mary Banquet Cart, Stainless Steel	70
BNQT-5	112598	Queen Mary Banquet Cart	70
BNQT-5/SS	232021	Queen Mary Banquet, SS	70
BP	Option	Pan Rack Plate Casters 4"	49
BP-2	180902	Bumpers, Set Of Two	113
CCRL-1S-100LB-PLASTICWT	578929	Side Wts for Cart Coral	119
CCRL-1S1R-1SWM-GEN	553289	Cart Corral	119
CDT-14-C-108L	--	Clean Dish Table	18
CDT-14-C-108R	--	Clean Dish Table	18
CDT-14-C-120L	--	Clean Dish Table	18
CDT-14-C-120R	--	Clean Dish Table	18
CDT-14-C-144L	--	Clean Dish Table	18
CDT-14-C-144R	--	Clean Dish Table	18
CDT-14-C-48L	399138	Clean Dish Table	18
CDT-14-C-48R	401411	Clean Dish Table	18
CDT-14-C-60L	399251	Clean Dish Table	18
CDT-14-C-60R	401429	Clean Dish Table	18
CDT-14-C-72L	399269	Clean Dish Table	18
CDT-14-C-72R	401437	Clean Dish Table	18
CDT-14-C-84L	399277	Clean Dish Table	18
CDT-14-C-84R	401445	Clean Dish Table	18

Model Number	Order#	Product Description	Page#
CDT-14-C-96L	399285	Clean Dish Table	18
CDT-14-C-96R	401453	Clean Dish Table	18
CDT-14-I-108L	--	Clean Dish Table	19
CDT-14-I-108R	--	Clean Dish Table	19
CDT-14-I-120L	--	Clean Dish Table	19
CDT-14-I-120R	--	Clean Dish Table	19
CDT-14-I-144L	--	Clean Dish Table	19
CDT-14-I-144R	--	Clean Dish Table	19
CDT-14-I-48L	399402	Clean Dish Table	19
CDT-14-I-48R	401517	Clean Dish Table	19
CDT-14-I-60L	399411	Clean Dish Table	19
CDT-14-I-60R	401525	Clean Dish Table	19
CDT-14-I-72L	399429	Clean Dish Table	19
CDT-14-I-72R	401533	Clean Dish Table	19
CDT-14-I-84L	399437	Clean Dish Table	19
CDT-14-I-84R	401541	Clean Dish Table	19
CDT-14-I-96L	399445	Clean Dish Table	19
CDT-14-I-96R	401550	Clean Dish Table	19
CDT-14-S-108L	679236	Clean Dish Table	17
CDT-14-S-108R	679244	Clean Dish Table	17
CDT-14-S-120L	402552	Clean Dish Table	17
CDT-14-S-120R	433156	Clean Dish Table	17
CDT-14-S-144L	679252	Clean Dish Table	17
CDT-14-S-144R	568252	Clean Dish Table	17
CDT-14-S-24L	581992	Clean Dish Table	17
CDT-14-S-24R	679210	Clean Dish Table	17
CDT-14-S-36L	399066	Clean Dish Table	17
CDT-14-S-36R	401269	Clean Dish Table	17
CDT-14-S-48L	399074	Clean Dish Table	17
CDT-14-S-48R	679228	Clean Dish Table	17
CDT-14-S-60L	396789	Clean Dish Table	17
CDT-14-S-60R	401314	Clean Dish Table	17
CDT-14-S-72L	399082	Clean Dish Table	17
CDT-14-S-72R	401322	Clean Dish Table	17
CDT-14-S-84L	399091	Clean Dish Table	17
CDT-14-S-84R	401331	Clean Dish Table	17
CDT-14-S-96L	401439	Clean Dish Table	17
CDT-14-S-96R	399103	Clean Dish Table	17
CDT-16-C-108L	679341	Clean Dish Table	18
CDT-16-C-108R	679322	Clean Dish Table	18
CDT-16-C-120L	--	Clean Dish Table	18
CDT-16-C-120R	--	Clean Dish Table	18
CDT-16-C-144L	--	Clean Dish Table	18
CDT-16-C-144R	--	Clean Dish Table	18
CDT-16-C-48L	399342	Clean Dish Table	18
CDT-16-C-48R	401365	Clean Dish Table	18
CDT-16-C-60L	399154	Clean Dish Table	18
CDT-16-C-60R	401373	Clean Dish Table	18
CDT-16-C-72L	399162	Clean Dish Table	18
CDT-16-C-72R	401381	Clean Dish Table	18
CDT-16-C-84L	399171	Clean Dish Table	18
CDT-16-C-84R	401390	Clean Dish Table	18
CDT-16-C-96L	399189	Clean Dish Table	18
CDT-16-C-96R	401402	Clean Dish Table	18
CDT-16-I-108L	--	Clean Dish Table	19
CDT-16-I-108R	--	Clean Dish Table	19
CDT-16-I-120L	--	Clean Dish Table	19
CDT-16-I-120R	--	Clean Dish Table	19
CDT-16-I-144L	--	Clean Dish Table	19
CDT-16-I-144R	--	Clean Dish Table	19
CDT-16-I-48L	400160	Clean Dish Table	19
CDT-16-I-48R	401461	Clean Dish Table	19

Model Number	Order#	Product Description	Page#
CDT-16-I-60L	399306	Clean Dish Table	19
CDT-16-I-60R	401470	Clean Dish Table	19
CDT-16-I-72L	399314	Clean Dish Table	19
CDT-16-I-72R	401488	Clean Dish Table	19
CDT-16-I-84L	399322	Clean Dish Table	19
CDT-16-I-84R	401496	Clean Dish Table	19
CDT-16-I-96L	399331	Clean Dish Table	19
CDT-16-I-96R	401509	Clean Dish Table	19
CDT-16-S-108L	679164	Clean Dish Table	17
CDT-16-S-108R	679156	Clean Dish Table	17
CDT-16-S-120L	679172	Clean Dish Table	17
CDT-16-S-120R	679181	Clean Dish Table	17
CDT-16-S-144L	679201	Clean Dish Table	17
CDT-16-S-144R	679199	Clean Dish Table	17
CDT-16-S-24L	595438	Clean Dish Table	17
CDT-16-S-24R	385001	Clean Dish Table	17
CDT-16-S-36L	394716	Clean Dish Table	17
CDT-16-S-36R	401171	Clean Dish Table	17
CDT-16-S-48L	398944	Clean Dish Table	17
CDT-16-S-48R	401189	Clean Dish Table	17
CDT-16-S-60L	398952	Clean Dish Table	17
CDT-16-S-60R	401197	Clean Dish Table	17
CDT-16-S-72L	398961	Clean Dish Table	17
CDT-16-S-72R	401218	Clean Dish Table	17
CDT-16-S-84L	398979	Clean Dish Table	17
CDT-16-S-84R	401234	Clean Dish Table	17
CDT-16-S-96L	398987	Clean Dish Table	17
CDT-16-S-96R	401242	Clean Dish Table	17
CORR	Option	Pan Rack Correctional Package	49
CORR	Option	Can Rack Correctional Package	58
CR-156F	229121	Gravity Fed-FIFO-Can Rack	59
CR-162	112491	Can Rack Stationary	58
CR-162AJ	112504	Can Rack Adjustable	58
CR-162M	112512	Can Rack Mobile	58
CR-54M	112521	Can Rack Mobile Station	59
CR-54PT	112547	Can Rack Mobile Station	59
CR-54S/S	112555	Can Rack Mobile Station	59
CR-72M	112563	Can Rack Mobile Station	59
CR-72PT	112571	Can Rack Mobile Station	59
CR-72S/S	112580	Can Rack Mobile Station	59
D-2020	102154	Cup/Glass/Plate Rack Dolly	75
D-2027	126105	Pizza Dough Box Dolly	75
D2027A-BPC	111270	AL Sheet Pan Truck	74
D2027-BPC	111245	AL Sheet Pan Truck	74
D2027-BPC-51H-HD	688642	HD AL Sheet Pan Truck	74
D2040/LD	632770	Cup/Glass/Plate Rack Dolly	75
D-60	100597	U-Boat - Best Value	109
DASQ-3-1220	133866	Economy Dunnage Rack	91
DASQ-3-1224	133891	Economy Dunnage Rack	91
DASQ-3-820	156161	Economy Dunnage Rack	91
DASQ-3-824	138237	Economy Dunnage Rack	91
DASQ-4-1220	133874	Economy Dunnage Rack	91
DASQ-4-1224	133903	Economy Dunnage Rack	91
DASQ-4-820	154018	Economy Dunnage Rack	91
DASQ-4-824	138245	Economy Dunnage Rack	91
DASQ-5-1220	133882	Economy Dunnage Rack	91
DASQ-5-1224	133911	Economy Dunnage Rack	91
DASQ-5-820	153550	Economy Dunnage Rack	91
DASQ-5-824	153568	Economy Dunnage Rack	91
DC-2-2149/72H	669855	Folding Distribution Cart	123
DC-2526-EG	651989	Folding Distribution Cart	123

Model Number	Order#	Product Description	Page#
DC-2538-EG	682478	Folding Distribution Cart	123
DIV-24128-EP	109680	Vinyl Wire Case Dividers	131
DIV-30128-EP	108484	Vinyl Wire Case Dividers	131
DPLSQ-3-1222-BK	408292	Plastic Dunnage Rack	92
DPLSQ-4-1222-BK	229041	Plastic Dunnage Rack	92
DPLSQ-5-1222-BK	408305	Plastic Dunnage Rack	92
DPTB-2436	163176	SS Work Table w/poly top	28
DPTB-2448	163184	SS Work Table w/poly top	28
DPTB-2460	163192	SS Work Table w/poly top	28
DPTB-2472	163205	SS Work Table w/poly top	28
DPTB-2484	163213	SS Work Table w/poly top	28
DPTB-2496	163221	SS Work Table w/poly top	28
DPTB-3036	163230	SS Work Table w/poly top	28
DPTB-3048	163248	SS Work Table w/poly top	28
DPTB-3060	163256	SS Work Table w/poly top	28
DPTB-3072	163264	SS Work Table w/poly top	28
DPTB-3084	163272	SS Work Table w/poly top	28
DPTB-3096	163281	SS Work Table w/poly top	28
DPTB-3636	163299	SS Work Table w/poly top	28
DPTB-3648	163301	SS Work Table w/poly top	28
DPTB-3660	163310	SS Work Table w/poly top	28
DPTB-3672	163328	SS Work Table w/poly top	28
DPTB-3684	163336	SS Work Table w/poly top	28
DPTB-3696	185148	SS Work Table w/poly top	28
DPTR-2436	162763	SS Work Table w/poly top	28
DPTR-2448	162771	SS Work Table w/poly top	28
DPTR-2460	162798	SS Work Table w/poly top	28
DPTR-2472	162587	SS Work Table w/poly top	28
DPTR-2484	162801	SS Work Table w/poly top	28
DPTR-2496	162579	SS Work Table w/poly top	28
DPTR-3036	162819	SS Work Table w/poly top	28
DPTR-3048	162835	SS Work Table w/poly top	28
DPTR-3060	162843	SS Work Table w/poly top	28
DPTR-3072	162851	SS Work Table w/poly top	28
DPTR-3084	162860	SS Work Table w/poly top	28
DPTR-3096	162886	SS Work Table w/poly top	28
DPTR-3636	162894	SS Work Table w/poly top	28
DPTR-3648	162907	SS Work Table w/poly top	28
DPTR-3660	162915	SS Work Table w/poly top	28
DPTR-3672	162923	SS Work Table w/poly top	28
DPTR-3684	162931	SS Work Table w/poly top	28
DPTR-3696	185105	SS Work Table w/poly top	28
DPTS-2436	162940	SS Work Table w/poly top	28
DPTS-2448	162958	SS Work Table w/poly top	28
DPTS-2460	162966	SS Work Table w/poly top	28
DPTS-2472	162982	SS Work Table w/poly top	28
DPTS-2484	162991	SS Work Table w/poly top	28
DPTS-2496	163002	SS Work Table w/poly top	28
DPTS-3036	163011	SS Work Table w/poly top	28
DPTS-3048	163029	SS Work Table w/poly top	28
DPTS-3060	163037	SS Work Table w/poly top	28
DPTS-3072	163045	SS Work Table w/poly top	28
DPTS-3084	163053	SS Work Table w/poly top	28
DPTS-3096	163096	SS Work Table w/poly top	28
DPTS-3636	163109	SS Work Table w/poly top	28
DPTS-3648	163117	SS Work Table w/poly top	28
DPTS-3660	163125	SS Work Table w/poly top	28
DPTS-3672	163133	SS Work Table w/poly top	28
DPTS-3684	163150	SS Work Table w/poly top	28
DPTS-3696	172574	SS Work Table w/poly top	28
DPTSB-2436	163344	SS Work Table w/poly top	28
DPTSB-2448	163352	SS Work Table w/poly top	28

Model Number	Order#	Product Description	Page#
DPTSB-2460	163361	SS Work Table w/poly top	28
DPTSB-2472	163379	SS Work Table w/poly top	28
DPTSB-2484	163387	SS Work Table w/poly top	28
DPTSB-2496	163395	SS Work Table w/poly top	28
DPTSB-3036	163408	SS Work Table w/poly top	28
DPTSB-3048	163416	SS Work Table w/poly top	28
DPTSB-3060	163424	SS Work Table w/poly top	28
DPTSB-3072	163432	SS Work Table w/poly top	28
DPTSB-3084	163441	SS Work Table w/poly top	28
DPTSB-3096	163459	SS Work Table w/poly top	28
DPTSB-3636	163467	SS Work Table w/poly top	28
DPTSB-3648	163475	SS Work Table w/poly top	28
DPTSB-3660	163483	SS Work Table w/poly top	28
DPTSB-3672	163491	SS Work Table w/poly top	28
DPTSB-3684	163504	SS Work Table w/poly top	28
DPTSB-3696	171897	SS Work Table w/poly top	28
DR-2143	365552	Bagel Display Rack	103
DR-2443	365544	Bread Display Rack	103
DRAL-3-1220	103472	Gusset Leg Dunnage Rack	92
DRAL-3-1224	103481	Gusset Leg Dunnage Rack	92
DRAL-4-1220	103499	Gusset Leg Dunnage Rack	92
DRAL-4-1224	103501	Gusset Leg Dunnage Rack	92
DRAL-5-1224	103528	Gusset Leg Dunnage Rack	92
DRS-3660-GRID	484586	KD Bread Rack Grid	102
DRS-3660KD-WM	483225	Knock-Down Bread Rack	102
DSN-2618	102074	Stack and Nest Dolly	76
DTB-2436	135642	Stainless Steel Work Table	27
DTB-2448	135651	Stainless Steel Work Table	27
DTB-2460	135669	Stainless Steel Work Table	27
DTB-2472	135677	Stainless Steel Work Table	27
DTB-2484	135685	Stainless Steel Work Table	27
DTB-2496	135693	Stainless Steel Work Table	27
DTB-3036	135714	Stainless Steel Work Table	27
DTB-3048	135722	Stainless Steel Work Table	27
DTB-3060	135731	Stainless Steel Work Table	27
DTB-3072	135749	Stainless Steel Work Table	27
DTB-3084	135757	Stainless Steel Work Table	27
DTB-3096	135765	Stainless Steel Work Table	27
DTB-3636	135781	Stainless Steel Work Table	27
DTB-3648	135790	Stainless Steel Work Table	27
DTB-3660	135802	Stainless Steel Work Table	27
DTB-3672	135811	Stainless Steel Work Table	27
DTB-3684	135829	Stainless Steel Work Table	27
DTB-3696*	135837	Stainless Steel Work Table	27
DTBB-2436	676166	SS Work Table FS Series	31
DTBB-2436/14GA	--	SS Work Table Consultant	31
DTBB-2448	676174	SS Work Table Foodservice	31
DTBB-2448/14GA	--	SS Work Table Consultant	31
DTBB-2460	676182	SS Work Table Foodservice	31
DTBB-2460/14GA	--	SS Work Table Consultant	31
DTBB-2472	676191	SS Work Table Foodservice	31
DTBB-2472/14GA	--	SS Work Table Consultant	31
DTBB-2484	676203	SS Work Table Foodservice	31
DTBB-2484/14GA	--	SS Work Table Consultant	31
DTBB-2496	676211	SS Work Table Foodservice	31
DTBB-2496/14GA	--	SS Work Table Consultant	31
DTBB-3036	545861	SS Work Table Foodservice	31
DTBB-3036/14GA	--	SS Work Table Consultant	31
DTBB-3048	676220	SS Work Table Foodservice	31
DTBB-3048/14GA	--	SS Work Table Consultant	31
DTBB-3060	676238	SS Work Table Foodservice	31
DTBB-3060/14GA	--	SS Work Table Consultant	31

Model Number	Order#	Product Description	Page#
DTBB-3072	676246	SS Work Table Foodservice	31
DTBB-3072/14GA	975271	SS Work Table Consultant	31
DTBB-3084	676254	SS Work Table Foodservice	31
DTBB-3084/14GA	--	SS Work Table Consultant	31
DTBB-3096	676262	SS Work Table Foodservice	31
DTBB-3096/14GA	--	SS Work Table Consultant	31
DTBB-3636	676271	SS Work Table Foodservice	31
DTBB-3636/14GA	--	SS Work Table Consultant	31
DTBB-3648	676289	SS Work Table Foodservice	31
DTBB-3648/14GA	--	SS Work Table Consultant	31
DTBB-3660	676297	SS Work Table Foodservice	31
DTBB-3660/14GA	--	SS Work Table Consultant	31
DTBB-3672	676300	SS Work Table Foodservice	31
DTBB-3672/14GA	--	SS Work Table Consultant	31
DTBB-3684	676318	SS Work Table Foodservice	31
DTBB-3684/14GA	--	SS Work Table Consultant	31
DTBB-3696*	676326	SS Work Table Foodservice	31
DTBB-3696/14GA	--	SS Work Table Consultant	31
DTR-2436	135191	SS Work Table Foodservice	30
DTR-2436/14GA	--	SS Work Table Consultant	30
DTR-2448	129146	SS Work Table Foodservice	30
DTR-2448/14GA	--	SS Work Table Consultant	30
DTR-2460	135247	SS Work Table Foodservice	30
DTR-2460/14GA	--	SS Work Table Consultant	30
DTR-2472	135255	SS Work Table Foodservice	30
DTR-2472/14GA	--	SS Work Table Consultant	30
DTR-2484	135263	SS Work Table Foodservice	30
DTR-2484/14GA	--	SS Work Table Consultant	30
DTR-2496	135271	SS Work Table Foodservice	30
DTR-2496/14GA	--	SS Work Table Consultant	30
DTR-3036	135298	SS Work Table Foodservice	30
DTR-3036/14GA	--	SS Work Table Consultant	30
DTR-3048	135301	SS Work Table Foodservice	30
DTR-3048/14GA	--	SS Work Table Consultant	30
DTR-3060	135319	SS Work Table Foodservice	30
DTR-3060/14GA	968679	SS Work Table Consultant	30
DTR-3072	135327	SS Work Table Foodservice	30
DTR-3072/14GA	968687	SS Work Table Consultant	30
DTR-3084	135335	SS Work Table Foodservice	30
DTR-3084/14GA	--	SS Work Table Consultant	30
DTR-3096	135343	SS Work Table Foodservice	30
DTR-3096/14GA	--	SS Work Table Consultant	30
DTR-3636	135360	SS Work Table Foodservice	30
DTR-3636/14GA	--	SS Work Table Consultant	30
DTR-3648	135378	SS Work Table Foodservice	30
DTR-3648/14GA	--	SS Work Table Consultant	30
DTR-3660	135386	SS Work Table Foodservice	30
DTR-3660/14GA	--	SS Work Table Consultant	30
DTR-3672	135394	SS Work Table Foodservice	30
DTR-3672/14GA	--	SS Work Table Consultant	30
DTR-3684	135407	SS Work Table Foodservice	30
DTR-3684/14GA	--	SS Work Table Consultant	30
DTR-3696	135415	SS Work Table Foodservice	30
DTR-3696/14GA	--	SS Work Table Consultant	30
DTS-2412	--	Filler Tables	42
DTS-2415	--	Filler Tables	42
DTS-2418	--	Filler Tables	42
DTS-2436	135431	SS Work Table Foodservice	30
DTS-2436/14GA	--	SS Work Table Consultant	30
DTS-2448	135440	SS Work Table Foodservice	30
DTS-2448/14GA	--	SS Work Table Consultant	30
DTS-2460	135458	SS Work Table Foodservice	30

Model Number	Order#	Product Description	Page#
DTS-2460/14GA	--	SS Work Table Consultant	30
DTS-2472	135466	SS Work Table Foodservice	30
DTS-2472/14GA	--	SS Work Table Consultant	30
DTS-2484	135474	SS Work Table Foodservice	30
DTS-2484/14GA	--	SS Work Table Consultant	30
DTS-2496	135482	SS Work Table Foodservice	30
DTS-2496/14GA	--	SS Work Table Consultant	30
DTS-3012	--	Filler Tables	42
DTS-3015	--	Filler Tables	42
DTS-3018	--	Filler Tables	42
DTS-3036	135503	SS Work Table Foodservice	30
DTS-3036/14GA	--	SS Work Table Consultant	30
DTS-3048	135511	SS Work Table Foodservice	30
DTS-3048/14GA	--	SS Work Table Consultant	30
DTS-3060	135520	SS Work Table Foodservice	30
DTS-3060/14GA	--	SS Work Table Consultant	30
DTS-3072	135538	SS Work Table Foodservice	30
DTS-3072/14GA	--	SS Work Table Consultant	30
DTS-3084	135546	SS Work Table Foodservice	30
DTS-3084/14GA	--	SS Work Table Consultant	30
DTS-3096	135554	SS Work Table Foodservice	30
DTS-3096/14GA	--	SS Work Table Consultant	30
DTS-3612	--	Filler Tables	42
DTS-3615	--	Filler Tables	42
DTS-3618	--	Filler Tables	42
DTS-3636	135571	SS Work Table Foodservice	30
DTS-3636/14GA	--	SS Work Table Consultant	30
DTS-3648	135589	SS Work Table Foodservice	30
DTS-3648/14GA	--	SS Work Table Consultant	30
DTS-3660	135597	SS Work Table Foodservice	30
DTS-3660/14GA	--	SS Work Table Consultant	30
DTS-3672	135600	SS Work Table Foodservice	30
DTS-3672/14GA	--	SS Work Table Consultant	30
DTS-3684	135618	SS Work Table Foodservice	30
DTS-3684/14GA	--	SS Work Table Consultant	30
DTS-3696	135626	SS Work Table Foodservice	30
DTS-3696/14GA	--	SS Work Table Consultant	30
DTSB-15-2412	--	Filler Tables	42
DTSB-15-2415	--	Filler Tables	42
DTSB-15-2418	--	Filler Tables	42
DTSB-15-3012	--	Filler Tables	42
DTSB-15-3015	--	Filler Tables	42
DTSB-15-3015	--	Filler Tables	42
DTSB-15-3018	--	Filler Tables	42
DTSB-15-3615	--	Filler Tables	42
DTSB-15-3618	--	Filler Tables	42
DTSB-2436	135853	Stainless Steel Work Table	27
DTSB-2448	135861	Stainless Steel Work Table	27
DTSB-2460	135870	Stainless Steel Work Table	27
DTSB-2472	135888	Stainless Steel Work Table	27
DTSB-2484	135896	Stainless Steel Work Table	27
DTSB-2496	135909	Stainless Steel Work Table	27
DTSB-3036	135925	Stainless Steel Work Table	27
DTSB-3048	135933	Stainless Steel Work Table	27
DTSB-3060	135941	Stainless Steel Work Table	27
DTSB-3072	135950	Stainless Steel Work Table	27
DTSB-3084	135968	Stainless Steel Work Table	27
DTSB-3096	135976	Stainless Steel Work Table	27
DTSB-3636	135992	Stainless Steel Work Table	27
DTSB-3648	136004	Stainless Steel Work Table	27
DTSB-3660	136012	Stainless Steel Work Table	27
DTSB-3672	136021	Stainless Steel Work Table	27
DTSB-3684	136039	Stainless Steel Work Table	27

Model Number	Order#	Product Description	Page#
DTSB-3696*	136047	Stainless Steel Work Table	27
DTSBB-2436	675972	SS Work Table Foodservice	31
DTSBB-2436/14GA	--	SS Work Table Consultant	31
DTSBB-2448	660746	SS Work Table Foodservice	31
DTSBB-2448/14GA	--	SS Work Table Consultant	31
DTSBB-2460	675981	SS Work Table Foodservice	31
DTSBB-2460/14GA	--	SS Work Table Consultant	31
DTSBB-2472	675999	SS Work Table Foodservice	31
DTSBB-2472/14GA	--	SS Work Table Consultant	31
DTSBB-2484	676001	SS Work Table Foodservice	31
DTSBB-2484/14GA	--	SS Work Table Consultant	31
DTSBB-2496	676019	SS Work Table Foodservice	31
DTSBB-2496/14GA	--	SS Work Table Consultant	31
DTSBB-3036	676060	SS Work Table Foodservice	31
DTSBB-3036/14GA	--	SS Work Table Consultant	31
DTSBB-3048	645757	SS Work Table Foodservice	31
DTSBB-3048/14GA	--	SS Work Table Consultant	31
DTSBB-3060	646549	SS Work Table Foodservice	31
DTSBB-3060/14GA	--	SS Work Table Consultant	31
DTSBB-3072	676078	SS Work Table Foodservice	31
DTSBB-3072/14GA	--	SS Work Table Consultant	31
DTSBB-3084	645036	SS Work Table Foodservice	31
DTSBB-3084/14GA	972512	SS Work Table Consultant	31
DTSBB-3096	676086	SS Work Table Foodservice	31
DTSBB-3096/14GA	--	SS Work Table Consultant	31
DTSBB-3636	676107	SS Work Table Foodservice	31
DTSBB-3636/14GA	--	SS Work Table Consultant	31
DTSBB-3648	676115	SS Work Table Foodservice	31
DTSBB-3648/14GA	--	SS Work Table Consultant	31
DTSBB-3660	676123	SS Work Table Foodservice	31
DTSBB-3660/14GA	--	SS Work Table Consultant	31
DTSBB-3672	676131	SS Work Table Foodservice	31
DTSBB-3672/14GA	--	SS Work Table Consultant	31
DTSBB-3684	676140	SS Work Table Foodservice	31
DTSBB-3684/14GA	--	SS Work Table Consultant	31
DTSBB-3696*	676158	SS Work Table Foodservice	31
DTSBB-3696/14GA	--	SS Work Table Consultant	31
EC1810-LSLD	651680	Enclosed Mobile Cabinet	68
EC1816-C	110795	Enclosed Mobile Cabinet	68
EC1824-C	110824	Enclosed Mobile Cabinet	68
EC1832-C	110832	Enclosed Mobile Cabinet	68
EC1832-CTLPURC	150383	Enclosed Mobile Cabinet Extra Heavy Duty	68
EC1840-C	110841	Enclosed Mobile Cabinet	68
EC1840-C/LD	150375	Enclosed Mobile Cabinet	68
EC1840-CTL	110859	Enclosed Mobile Cabinet Extra Heavy Duty	68
EC1840-CTLPURC	110904	Enclosed Mobile Cabinet Extra Heavy Duty	68
EC-2-3060-DEF	652703	Security Cages	124
EC-3-3048-ADJ	628615	Security Cages	124
ES/C03048	207706	Convection Oven Stand	43
ES/M-2424	--	Equipment Stand 16 GA	42
ES/M-2424/14GA	--	Equipment Stand 14 GA	42
ES/M-2436	--	Equipment Stand 16 GA	42
ES/M-2436/14GA	--	Equipment Stand 14 GA	42
ES/M-2448	--	Equipment Stand 16 GA	42
ES/M-2448/14GA	--	Equipment Stand 14 GA	42
ES/M-2460	--	Equipment Stand 16 GA	42
ES/M-2460/14GA	--	Equipment Stand 14 GA	42
ES/M-2472	--	Equipment Stand 16 GA	42
ES/M-2472/14GA	--	Equipment Stand 14 GA	42
ES/M-2484	--	Equipment Stand 16 GA	42

Model Number	Order#	Product Description	Page#
ES/M-2484/14GA	--	Equipment Stand 14 GA	42
ES/M-2496	--	Equipment Stand 16 GA	42
ES/M-2496/14GA	--	Equipment Stand 14 GA	42
ES/M-3024	--	Equipment Stand 16 GA	42
ES/M-3024/14GA	--	Equipment Stand 14 GA	42
ES/M-3036	--	Equipment Stand 16 GA	42
ES/M-3036/14GA	--	Equipment Stand 14 GA	42
ES/M-3048	--	Equipment Stand 16 GA	42
ES/M-3048/14GA	--	Equipment Stand 14 GA	42
ES/M-3060	--	Equipment Stand 16 GA	42
ES/M-3060/14GA	--	Equipment Stand 14 GA	42
ES/M-3072	--	Equipment Stand 16 GA	42
ES/M-3072/14GA	--	Equipment Stand 14 GA	42
ES/M-3084	--	Equipment Stand 16 GA	42
ES/M-3084/14GA	--	Equipment Stand 14 GA	42
ES/M-3096	--	Equipment Stand 16 GA	42
ES/M-3096/14GA	--	Equipment Stand 14 GA	42
ES/MX2424/14GA	--	Mixer/Slicer Stand	43
ES/MX2424/UT/14GA	--	Mixer/Slicer Stand with Tree	43
ES/MX2430/14GA	--	Mixer/Slicer Stand	43
ES/MX2430/UT/14GA	--	Mixer/Slicer Stand with Tree	43
ES/MX3030/14GA	--	Mixer/Slicer Stand	43
ES/MX3030/UT/14GA	--	Mixer/Slicer Stand with Tree	43
ES/MX3036/14GA	--	Mixer/Slicer Stand	43
ES/MX3036/UT/14GA	--	Mixer/Slicer Stand with Tree	43
ES/S1622	207642	Equipment Stand Scale	43
ES/S2428	206779	Equipment Stand Machine	42
FFR-18	183513	French Fry Rack	62
FFR-27	183521	French Fry Rack	62
FL-CSSB	Option	Option Mop Sink coved seam sealers back flashings	15
FL-CSSRL	Option	Option Mop Sink coved seam sealers for right, left or both flashings	15
FL-SFHOLE	Option	Option Mop Sink service faucet hole	15
GR-60KD/RX	204548	Utility Cart Garment Bar Accessory	111
H-105	123887	NHPL Drawer Assembly	143
H-106-1	232784	NHPL Drawer Assembly	143
H-106-2B	232805	NHPL Drawer Assembly	143
H-107	123908	NHPL Drawer Assembly	143
H-108	123916	NHPL Drawer Assembly	143
H-220	170851	NHPL Drawer Assembly	143
H-225-B	637095	NHPL Drawer Assembly	143
H-226	170907	NHPL Drawer Assembly	143
H-227	170915	NHPL Drawer Assembly	143
H-228	170923	NHPL Drawer Assembly	143
IB-S216W/P16NF	270810	Ingredient Bin, Single SS	72
INHPL-1836C	684609	Heater Proofer, Insulated	67
K/D	Option	Pan Rack Option Knock down	49
KR-14	113312	Knife Rack	38
KR-23	113321	Knife Rack	38
KR-CLIPS	113339	Knife Rack Clips	38
Label-Locker-Number	654784	Custom Locker Numbering Sequence	137
LB	Option	Option - "L" Corner Bumper EXTRA HD Pan & Universal Racks	50
LC	Option	Pan Rack Option Locking Casters	49
LC Cooler Shelving	Option	Locking Brake for Mobile Cooler Shelving	88

Model Number	Order#	Product Description	Page#
LFL	Option	Option Mop Sink left flashings	15
LID-2618	104416	Lid, Gray Polyethylene	129
LSB-1BK	129218	Market Basket, Black	131
LSB-1BL	108038	Market Basket, Blue	131
LSB-1GR	108046	Market Basket, Green	131
LSB-1RD	108062	Market Basket, Red	131
LSB-1YW	108071	Market Basket, Yellow	131
LSB-DIE	162261	Shopping Basket Custom Die Charge	131
LSB-IMP	129234	Shopping Basket Imprint charge per basket	131
LSB-KIT-RD	129373	Kit with 12 red baskets & stand	131
LSB-STD	126800	Steel Stand	131
LSP	Option	Left Sidesplash for Hand Sink	14
LT-2	126252	Ladder Truck	115
M2LC	Option	Caster option for tables	29
M2LC	Option	Caster option for tables	31
M3LC	Option	Caster option for tables	31
M4LC	Option	Caster option for tables	31
M6LC	Option	Caster option for tables	31
MLC	Option	Correctional Shelving Option Mobile Unit with Casters	90
MM-1948	630256	Slant Merchandiser	104
MRC-6	126068	Mobile Cooling Rack	62
MS-1620-DP12-KT	675041	Mop Sink	15
MS-1620-DP6-KT	675032	Mop Sink	15
MS-2424-DP8-KT	675059	Mop Sink	15
MSLCK-1	520487	Combination Lock	137
NHPL-1810/HHC	684625	Heater Proofer, 1/2 Height	65
NHPL-1810/HH-DR GSKT	681416	Gasket for HP 1810 door	143
NHPL-1825-UNC	684641	Heater/Proofer Non-Insulated Universal Runner	66
NHPL-1825-UN-Runner	657150	(1) Replacement Runner UN HP	143
NHPL-1836C	684684	Heater/Proofer Non-Insulated Standard	65
NHPL-1836-ECOC	684668	Heater/Proofer Non-Insulated Economy	64
NHPL-DR	247505	Replacement Lexan Door for NHPL	143
NHPL1825-UN-DR GSKT	681328	Gasket for HP 1825 door	143
NHPL1836-DR GSKT	650484	Gasket for HP 1836 door	143
NHP-PD-ECO	631208	Replacement Economy Drawer	141
OT-78	101240	Receiving Desk	138
OTE-2224	101274	Receiving Desk	138
OTE-2224-GY	151968	Receiving Desk	138
OTE-2227E1-GY	244081	Receiving Desk	138
OTE-78	101282	Receiving Desk	138
Oven Racks	--	Winholt Equipment offers a wide range of Oven Racks in all styles and sizes.	60
P300-60	185009	Plastic deck U Boat	110
P300-60/PU	185017	Plastic deck U Boat	110
PAS-60	192541	U Boat Shelf	111
PBC-1830A	245032	Plastic Bussing, Utility, Service Cart	77
PD-18263	107983	Pizza dough boxes	127
PDP-6	101645	Drip Pan	93
PDR-3-36772/KD	487808	Plant & General Merchandise Merchandiser	104
PEB	Option	Option - Full Peramitor Bumper EXTRA HD Pan & Universal Racks	50 & 52

Model Number	Order#	Product Description	Page#
PH-1	101830	Pull Handle	75
PLSQ-3-1222-GY	207757	Plastic Dunnage Rack	92
PLSQ-4-1222-GY	207765	Plastic Dunnage Rack	92
PLSQ-5-1222-GY	207773	Plastic Dunnage Rack	92
PN2448	176760	Plastic Nesting Cart	113
PN2448F	177842	Plastic Nesting Cart	113
PN2448R	177834	Plastic Nesting Cart	113
PN3060	174959	Plastic Nesting Cart	113
PN3060F	177818	Plastic Nesting Cart	113
PN3060R	177826	Plastic Nesting Cart	113
PNC-1-WM/PU-GR	621093	Plastic Nesting Cart	113
PP	Option	Option - Prison Package EXTRA HD Pan & Universal Racks	50 &52
PP2448/4	176719	Plastic Deck Platform Truck	113
PP2448/6	176727	Plastic Deck Platform Truck	113
PP3060/4	174932	Plastic Deck Platform Truck	113
PP3060/6	174941	Plastic Deck Platform Truck	113
PPR-13	206818	Pizza Pan Rack	55
PPR-26	206826	Pizza Pan Rack	55
PRB-2020-2.5	--	Pre-Rinse Basket for Dish Table	21
PRB-2020-6	--	Pre-Rinse Basket for Dish Table	21
PT34-1218	192268	Cutting Board Poly Top	132
PT34-1520	253471	Cutting Board Poly Top	132
PT34-1836	146157	Cutting Board Poly Top	132
PT34-2424	108759	Cutting Board Poly Top	132
PT34-2430	127706	Cutting Board Poly Top	132
PT34-3036	146018	Cutting Board Poly Top	132
PT58-1218	253446	Cutting Board Poly Top	132
PT58-1520	250026	Cutting Board Poly Top	132
PUC-2436/2S	248292	Plastic Utility Cart	77
RDMWN-3	101354	Steel Receiving Desk Mobile	139
RDMWNSS-3	156081	SS Receiving Desk Mobile	140
RDSWN-2	101362	Steel Receiving Desk Stationary	139
RDSWN-4	130180	Steel Receiving Desk Stationary	139
RDSWN-5	129066	Steel Receiving Desk Enclosed Stationary	139
RDSWNSS-2	152848	SS Receiving Desk Stationary	140
RDSWNSS-5	240688	SS Receiving Enclosed Stationary	140
RDWN-1	101371	Steel Receiving Desk Wall Mount	139
RDWNSS-1	152830	SS Receiving Desk Wall Mount	140
RFL	Option	Option Mop Sink right flashings	15
RS-2020	425578	Rack Slide for Dish Table	21
RSP	Option	Right Sidesplash for Hand Sink	14
SAS1836	106981	Sani-Adjustable AL Shelf	86
SAS1848	107001	Sani-Adjustable AL Shelf	86
SAS1860	107019	Sani-Adjustable AL Shelf	86
SAS1872	107027	Sani-Adjustable AL Shelf	86
SAS2036	107060	Sani-Adjustable AL Shelf	86
SAS2048	107086	Sani-Adjustable AL Shelf	86
SAS2060	107094	Sani-Adjustable AL Shelf	86
SAS2072	107115	Sani-Adjustable AL Shelf	86
SAS2096	107123	Sani-Adjustable AL Shelf	86
SAS2436	107140	Sani-Adjustable AL Shelf	86
SAS2448	107166	Sani-Adjustable AL Shelf	86
SAS2460	107174	Sani-Adjustable AL Shelf	86

Model Number	Order#	Product Description	Page#
SAS2472	107182	Sani-Adjustable AL Shelf	86
SAS-MK	106913	Swivel Casters For Sani- Adjustable Shelving	87
SASP-54	107211	Pole for Sani-Adjustable Shelving	87
SASP-68	107220	Pole for Sani-Adjustable Shelving	87
SASP-76	107262	Pole for Sani-Adjustable Shelving	87
SASP-84	167775	Pole for Sani-Adjustable Shelving	87
SASP-ADJ	107297	Adjustabel Bullet Legs/Set of (4)	87
SASSR1848	107553	Reinforced Solid Shelf	87
SASSR1860	107561	Reinforced Solid Shelf	87
SASSR2036	107570	Reinforced Solid Shelf	87
SASSR2048	107588	Reinforced Solid Shelf	87
SASSR2060	107596	Reinforced Solid Shelf	87
SASSR2436	107617	Reinforced Solid Shelf	87
SASSR2448	107625	Reinforced Solid Shelf	87
SASSR2460	107633	Reinforced Solid Shelf	87
SB	Option	Option - Solid Base EXTRA HD Pan & Universal Racks	50 &52
SB	Option	Pan Rack Option Solid Bottom	49
SC-1638-GR-FM	655314	Overstock Stock Cart	112
SC1652T	232223	Utility Stock Cart	117
SC-1836/6W/GN	659083	Utility Stock Cart	114
SC-1848/6W/GN	632374	Utility Stock Cart	114
SC-6-2537M/E/AL	471970	Shelf Cart, Aluminum	124
SCAS-1836	104820	Tubular Shelf	85
SCAS-1836-3-AU	--	Cantilver Shelving Add on Kit Tubular	82
SCAS-1836-3-SU	--	Cantilver Shelving Starter Kit Tubular	82
SCAS-1836-4-AU	691059	Cantilver Shelving Add on Kit Tubular	82
SCAS-1836-4-SU	--	Cantilver Shelving Starter Kit Tubular	82
SCAS-1848	104838	Tubular Shelf	85
SCAS-1848-3-AU	683930	Cantilver Shelving Add on Kit Tubular	82
SCAS-1848-3-SU	690179	Cantilver Shelving Starter Kit Tubular	82
SCAS-1848-4-AU	691083	Cantilver Shelving Add on Kit Tubular	82
SCAS-1848-4-SU	691067	Cantilver Shelving Starter Kit Tubular	82
SCAS-1860	104846	Tubular Shelf	85
SCAS-1860-3-AU	--	Cantilver Shelving Add on Kit Tubular	82
SCAS-1860-3-SU	--	Cantilver Shelving Starter Kit Tubular	82
SCAS-1860-4-AU	690187	Cantilver Shelving Add on Kit Tubular	82
SCAS-1860-4-SU	691075	Cantilver Shelving Starter Kit Tubular	82
SCAS-2136	104926	Tubular Shelf	85
SCAS-2136-3-AU	649820	Cantilver Shelving Add on Kit Tubular	82
SCAS-2136-3-SU	649811	Cantilver Shelving Starter Kit Tubular	82
SCAS-2136-4-AU	--	Cantilver Shelving Add on Kit Tubular	82
SCAS-2136-4-SU	952917	Cantilver Shelving Starter Kit Tubular	82
SCAS-2148	104934	Tubular Shelf	85

Model Number	Order#	Product Description	Page#
SCAS-2148-3-AU	649862	Cantilver Shelving Add on Kit Tubular	82
SCAS-2148-3-SU	649230	Cantilver Shelving Starter Kit Tubular	82
SCAS-2148-4-AU	668254	Cantilver Shelving Add on Kit Tubular	82
SCAS-2148-4-SU	668246	Cantilver Shelving Starter Kit Tubular	82
SCAS-2160	104942	Tubular Shelf	85
SCAS-2160-3-AU	678621	Cantilver Shelving Add on Kit Tubular	82
SCAS-2160-3-SU	680894	Cantilver Shelving Starter Kit Tubular	82
SCAS-2160-4-AU	--	Cantilver Shelving Add on Kit Tubular	82
SCAS-2160-4-SU	952896	Cantilver Shelving Starter Kit Tubular	82
SCAS-2436	104969	Tubular Shelf	85
SCAS-2436-3-AU	661597	Cantilver Shelving Add on Kit Tubular	82
SCAS-2436-3-SU	661600	Cantilver Shelving Starter Kit Tubular	82
SCAS-2436-4-AU	658478	Cantilver Shelving Add on Kit Tubular	82
SCAS-2436-4-SU	653749	Cantilver Shelving Starter Kit Tubular	82
SCAS-2448	104977	Tubular Shelf	85
SCAS-2448-3-AU	642821	Cantilver Shelving Add on Kit Tubular	82
SCAS-2448-3-SU	642812	Cantilver Shelving Starter Kit Tubular	82
SCAS-2448-4-AU	642425	Cantilver Shelving Add on Kit Tubular	82
SCAS-2448-4-SU	642417	Cantilver Shelving Starter Kit Tubular	82
SCAS-2460	104985	Tubular Shelf	85
SCAS-2460-3-AU	699392	Cantilver Shelving Add on Kit Tubular	82
SCAS-2460-3-SU	690398	Cantilver Shelving Starter Kit Tubular	82
SCAS-2460-4-AU	658460	Cantilver Shelving Add on Kit Tubular	82
SCAS-2460-4-SU	658451	Cantilver Shelving Starter Kit Tubular	82
SCASC-36	105671	Cross Brace	85
SCASC-48	105689	Cross Brace	85
SCASC-60	105697	Cross Brace	85
SCASCH-2436	206762	E-Channel Cantilever Shelf	85
SCASCH-2436-3-AU	--	Cantilver Shelving Add-on Kit E Channel	83
SCASCH-2436-4-AU	--	Cantilver Shelving Add-on Kit E Channel	83
SCASCH-2436-4-SU	--	Cantilver Shelving Starter Kit E Channel	83
SCASCH-2448	206771	Channel Cantilever Shelf	85
SCASCH-2448-3-AU	--	Cantilver Shelving Add-on Kit E Channel	83
SCASCH-2448-4-AU	--	Cantilver Shelving Add-on Kit E Channel	83
SCASCH-2448-4-SU	988549	Cantilver Shelving Starter Kit E Channel	83
SCASCH-2460	206789	Channel Cantilever Shelf	85
SCASCH-2460-3-AU	--	Cantilver Shelving Add-on Kit E Channel	83
SCASCH-2460-3-SU	--	Cantilver Shelving Starter Kit E Channel	83
SCASCH-2460-4-AU	--	Cantilver Shelving Add-on Kit E Channel	83

Model Number	Order#	Product Description	Page#
SCASCH-2460-4-SU	988557	Cantilver Shelving Starter Kit E Channel	83
SCAS-HW	105451	Hardware Kit	85
SCASS-1836	105996	Solid Reinforced Shelf	85
SCASS-1836-3-AU	--	Cantilver Shelving Add-on Kit Solid Reinforced	83
SCASS-1836-3-SU	992089	Cantilver Shelving Starter Kit Solid Reinforced	83
SCASS-1836-4-AU	681070	Cantilver Shelving Add-on Kit Solid Reinforced	83
SCASS-1836-4-SU	--	Cantilver Shelving Starter Kit Solid Reinforced	83
SCASS-1848	106008	Solid Reinforced Shelf	85
SCASS-1848-3-AU	--	Cantilver Shelving Add-on Kit Solid Reinforced	83
SCASS-1848-3-SU	--	Cantilver Shelving Starter Kit Solid Reinforced	83
SCASS-1848-4-AU	--	Cantilver Shelving Add-on Kit Solid Reinforced	83
SCASS-1848-4-SU	--	Cantilver Shelving Starter Kit Solid Reinforced	83
SCASS-1860	106016	Solid Reinforced Shelf	85
SCASS-1860-3-AU	--	Cantilver Shelving Add-on Kit Solid Reinforced	83
SCASS-1860-3-SU	--	Cantilver Shelving Starter Kit Solid Reinforced	83
SCASS-1860-4-AU	--	Cantilver Shelving Add-on Kit Solid Reinforced	83
SCASS-1860-4-SU	--	Cantilver Shelving Starter Kit Solid Reinforced	83
SCASS-2136	106075	Solid Reinforced Shelf	85
SCASS-2136-3-AU	--	Cantilver Shelving Add-on Kit Solid Reinforced	83
SCASS-2136-3-SU	--	Cantilver Shelving Starter Kit Solid Reinforced	83
SCASS-2136-4-AU	681088	Cantilver Shelving Add-on Kit Solid Reinforced	83
SCASS-2136-4-SU	--	Cantilver Shelving Starter Kit Solid Reinforced	83
SCASS-2148	106083	Solid Reinforced Shelf	85
SCASS-2148-3-AU	--	Cantilver Shelving Add-on Kit Solid Reinforced	83
SCASS-2148-3-SU	979271	Cantilver Shelving Starter Kit Solid Reinforced	83
SCASS-2148-4-AU	681096	Cantilver Shelving Add-on Kit Solid Reinforced	83
SCASS-2148-4-SU	--	Cantilver Shelving Starter Kit Solid Reinforced	83
SCASS-2160	106091	Solid Reinforced Shelf	85
SCASS-2160-3-AU	698470	Cantilver Shelving Add-on Kit Solid Reinforced	83
SCASS-2160-3-SU	--	Cantilver Shelving Starter Kit Solid Reinforced	83
SCASS-2160-4-AU	--	Cantilver Shelving Add-on Kit Solid Reinforced	83
SCASS-2160-4-SU	--	Cantilver Shelving Starter Kit Solid Reinforced	83
SCASS-2436	106112	Solid Reinforced Shelf	85
SCASS-2436-3-AU	--	Cantilver Shelving Add-on Kit Solid Reinforced	83
SCASS-2436-3-SU	--	Cantilver Shelving Starter Kit Solid Reinforced	83
SCASS-2436-4-AU	--	Cantilver Shelving Add-on Kit Solid Reinforced	83
SCASS-2436-4-SU	669151	Cantilver Shelving Starter Kit Solid Reinforced	83
SCASS-2448	106121	Solid Reinforced Shelf	85
SCASS-2448-3-AU	681555	Cantilver Shelving Add-on Kit Solid Reinforced	83

Model Number	Order#	Product Description	Page#
SCASS-2448-3-SU	681547	Cantilver Shelving Starter Kit Solid Reinforced	83
SCASS-2448-4-AU	686410	Cantilver Shelving Add-on Kit Solid Reinforced	83
SCASS-2448-4-SU	669142	Cantilver Shelving Starter Kit Solid Reinforced	83
SCASS-2460	106139	Solid Reinforced Shelf	85
SCASS-2460-3-AU	979280	Cantilver Shelving Add-on Kit Solid Reinforced	83
SCASS-2460-3-SU	--	Cantilver Shelving Starter Kit Solid Reinforced	83
SCASS-2460-4-AU	677687	Cantilver Shelving Add-on Kit Solid Reinforced	83
SCASS-2460-4-SU	677679	Cantilver Shelving Starter Kit Solid Reinforced	83
SCAST-1836	163969	T-Bar Shelf	85
SCAST-1836-3-AU	--	Cantilver Shelving Add on Kit T-Bar	82
SCAST-1836-4-SU	991131	Cantilver Shelving Starter Kit T-Bar	82
SCAST-1848	163977	T-Bar Shelf	85
SCAST-1860	163985	T-Bar Shelf	85
SCAST-1860-3-AU	--	Cantilver Shelving Add on Kit T-Bar	82
SCAST-1860-4-AU	--	Cantilver Shelving Add on Kit T-Bar	82
SCAST-1860-4-SU	--	Cantilver Shelving Starter Kit T-Bar	82
SCAST-2436	164021	T-Bar Shelf	85
SCAST-2436-3-AU	--	Cantilver Shelving Add on Kit T-Bar	82
SCAST-2436-3-SU	--	Cantilver Shelving Starter Kit T-Bar	82
SCAST-2436-4-AU	--	Cantilver Shelving Add on Kit T-Bar	82
SCAST-2436-4-SU	--	Cantilver Shelving Starter Kit T-Bar	82
SCAST-2448	164030	T-Bar Shelf	85
SCAST-2448-3-AU	--	Cantilver Shelving Add on Kit T-Bar	82
SCAST-2448-3-SU	--	Cantilver Shelving Starter Kit T-Bar	82
SCAST-2448-4-AU	--	Cantilver Shelving Add on Kit T-Bar	82
SCAST-2448-4-SU	--	Cantilver Shelving Starter Kit T-Bar	82
SCAST-2460	164048	T-Bar Shelf	85
SCAST-2460-3-AU	--	Cantilver Shelving Add on Kit T-Bar	82
SCAST-2460-3-SU	--	Cantilver Shelving Starter Kit T-Bar	82
SCAST-2460-4-AU	--	Cantilver Shelving Add on Kit T-Bar	82
SCAST-2460-4-SU	--	Cantilver Shelving Starter Kit T-Bar	82
SCASU-21	106500	Up-Right Common	85
SCASU-21L	106518	Up-Right, Left	85
SCASU-21R	106526	Up-Right, Right	85
SCASU-24	106534	Up-Right, Common	85
SCASU-24L	106542	Up-Right, Left	85
SCASU-24R	106551	Up-Right, Right	85
SD-1/24	217331	WinFab Table Modification	38
SD-1/30	217349	WinFab Table Modification	38
SD-1/36	217357	WinFab Table Modification	38
SD-2	299786	WinFab Table Modification	38
SD-3RB	452517	WinFab Table Modification	38
SD-3RB/24	565116	WinFab Table Modification	38
SDT-14-C-108L	--	Soiled Dish Table	18

Model Number	Order#	Product Description	Page#
SDT-14-C-108R	--	Soiled Dish Table	18
SDT-14-C-120L	--	Soiled Dish Table	18
SDT-14-C-120R	--	Soiled Dish Table	18
SDT-14-C-144L	--	Soiled Dish Table	18
SDT-14-C-144R	--	Soiled Dish Table	18
SDT-14-C-48L	399461	Soiled Dish Table	18
SDT-14-C-48R	401736	Soiled Dish Table	18
SDT-14-C-60L	401744	Soiled Dish Table	18
SDT-14-C-60R	399470	Soiled Dish Table	18
SDT-14-C-72L	399488	Soiled Dish Table	18
SDT-14-C-72R	401752	Soiled Dish Table	18
SDT-14-C-84L	399496	Soiled Dish Table	18
SDT-14-C-84R	401761	Soiled Dish Table	18
SDT-14-C-96L	399509	Soiled Dish Table	18
SDT-14-C-96R	401779	Soiled Dish Table	18
SDT-14-I-108L	--	Soiled Dish Table	19
SDT-14-I-108R	--	Soiled Dish Table	19
SDT-14-I-120L	--	Soiled Dish Table	19
SDT-14-I-120R	--	Soiled Dish Table	19
SDT-14-I-144L	--	Soiled Dish Table	19
SDT-14-I-144R	--	Soiled Dish Table	19
SDT-14-I-48L	400071	Soiled Dish Table	19
SDT-14-I-48R	401787	Soiled Dish Table	19
SDT-14-I-60L	400098	Soiled Dish Table	19
SDT-14-I-60R	401795	Soiled Dish Table	19
SDT-14-I-72L	401101	Soiled Dish Table	19
SDT-14-I-72R	401808	Soiled Dish Table	19
SDT-14-I-84L	401816	Soiled Dish Table	19
SDT-14-I-84R	400127	Soiled Dish Table	19
SDT-14-I-96L	400135	Soiled Dish Table	19
SDT-14-I-96R	401824	Soiled Dish Table	19
SDT-14-L-108L	--	Soiled Dish Table	20
SDT-14-L-108R	--	Soiled Dish Table	20
SDT-14-L-120L	--	Soiled Dish Table	20
SDT-14-L-120R	--	Soiled Dish Table	20
SDT-14-L-144L	972379	Soiled Dish Table	20
SDT-14-L-144R	--	Soiled Dish Table	20
SDT-14-L-48L	403002	Soiled Dish Table	20
SDT-14-L-48R	402991	Soiled Dish Table	20
SDT-14-L-60L	403029	Soiled Dish Table	20
SDT-14-L-60R	403307	Soiled Dish Table	20
SDT-14-L-72L	403503	Soiled Dish Table	20
SDT-14-L-72R	403045	Soiled Dish Table	20
SDT-14-L-84L	403061	Soiled Dish Table	20
SDT-14-L-84R	403070	Soiled Dish Table	20
SDT-14-L-96L	403096	Soiled Dish Table	20
SDT-14-L-96R	403088	Soiled Dish Table	20
SDT-14-S-108L	679092	Soiled Dish Table	17
SDT-14-S-108R	679105	Soiled Dish Table	17
SDT-14-S-120L	679113	Soiled Dish Table	17
SDT-14-S-120R	679121	Soiled Dish Table	17
SDT-14-S-144L	679130	Soiled Dish Table	17
SDT-14-S-144R	679148	Soiled Dish Table	17
SDT-14-S-36L	399841	Soiled Dish Table	17
SDT-14-S-36R	401568	Soiled Dish Table	17
SDT-14-S-48L	399867	Soiled Dish Table	17
SDT-14-S-48R	401576	Soiled Dish Table	17
SDT-14-S-60L	399891	Soiled Dish Table	17
SDT-14-S-60R	401584	Soiled Dish Table	17
SDT-14-S-72L	399912	Soiled Dish Table	17
SDT-14-S-72R	401592	Soiled Dish Table	17
SDT-14-S-84L	679084	Soiled Dish Table	17

Model Number	Order#	Product Description	Page#
SDT-14-S-84R	634943	Soiled Dish Table	17
SDT-14-S-96L	399939	Soiled Dish Table	17
SDT-14-S-96R	401605	Soiled Dish Table	17
SDT-16-C-108L	679332	Soiled Dish Table	18
SDT-16-C-108R	679341	Soiled Dish Table	18
SDT-16-C-120L	--	Soiled Dish Table	18
SDT-16-C-120R	--	Soiled Dish Table	18
SDT-16-C-144L	--	Soiled Dish Table	18
SDT-16-C-144R	--	Soiled Dish Table	18
SDT-16-C-48L	399138	Soiled Dish Table	18
SDT-16-C-48R	401365	Soiled Dish Table	18
SDT-16-C-60L	399154	Soiled Dish Table	18
SDT-16-C-60R	401373	Soiled Dish Table	18
SDT-16-C-72L	399162	Soiled Dish Table	18
SDT-16-C-72R	401381	Soiled Dish Table	18
SDT-16-C-84L	399171	Soiled Dish Table	18
SDT-16-C-84R	401390	Soiled Dish Table	18
SDT-16-C-96L	399189	Soiled Dish Table	18
SDT-16-C-96R	401402	Soiled Dish Table	18
SDT-16-I-108L	--	Soiled Dish Table	19
SDT-16-I-108R	--	Soiled Dish Table	19
SDT-16-I-120L	--	Soiled Dish Table	19
SDT-16-I-120R	--	Soiled Dish Table	19
SDT-16-I-144L	--	Soiled Dish Table	19
SDT-16-I-144R	--	Soiled Dish Table	19
SDT-16-I-48L	400160	Soiled Dish Table	19
SDT-16-I-48R	401841	Soiled Dish Table	19
SDT-16-I-60L	400178	Soiled Dish Table	19
SDT-16-I-60R	401867	Soiled Dish Table	19
SDT-16-I-72L	400186	Soiled Dish Table	19
SDT-16-I-72R	401883	Soiled Dish Table	19
SDT-16-I-84L	400194	Soiled Dish Table	19
SDT-16-I-84R	401891	Soiled Dish Table	19
SDT-16-I-96L	400207	Soiled Dish Table	19
SDT-16-I-96R	401904	Soiled Dish Table	19
SDT-16-L-108L	--	Soiled Dish Table	20
SDT-16-L-108R	--	Soiled Dish Table	20
SDT-16-L-120L	--	Soiled Dish Table	20
SDT-16-L-120R	--	Soiled Dish Table	20
SDT-16-L-144L	--	Soiled Dish Table	20
SDT-16-L-144R	--	Soiled Dish Table	20
SDT-16-L-48L	403205	Soiled Dish Table	20
SDT-16-L-48R	403192	Soiled Dish Table	20
SDT-16-L-60L	403213	Soiled Dish Table	20
SDT-16-L-60R	403221	Soiled Dish Table	20
SDT-16-L-72L	403248	Soiled Dish Table	20
SDT-16-L-72R	403230	Soiled Dish Table	20
SDT-16-L-84L	403256	Soiled Dish Table	20
SDT-16-L-84R	403264	Soiled Dish Table	20
SDT-16-L-96L	403272	Soiled Dish Table	20
SDT-16-L-96R	403281	Soiled Dish Table	20
SDT-16-S-108L	679025	Soiled Dish Table	17
SDT-16-S-108R	679033	Soiled Dish Table	17
SDT-16-S-120L	679050	Soiled Dish Table	17
SDT-16-S-120R	679041	Soiled Dish Table	17
SDT-16-S-144L	679068	Soiled Dish Table	17
SDT-16-S-144R	679076	Soiled Dish Table	17
SDT-16-S-36L	399963	Soiled Dish Table	17
SDT-16-S-36R	401613	Soiled Dish Table	17
SDT-16-S-48L	399971	Soiled Dish Table	17
SDT-16-S-48R	401621	Soiled Dish Table	17
SDT-16-S-60L	399980	Soiled Dish Table	17

Model Number	Order#	Product Description	Page#
SDT-16-S-60R	401630	Soiled Dish Table	17
SDT-16-S-72L	399998	Soiled Dish Table	17
SDT-16-S-72R	601648	Soiled Dish Table	17
SDT-16-S-84L	400004	Soiled Dish Table	17
SDT-16-S-84R	401656	Soiled Dish Table	17
SDT-16-S-96L	400012	Soiled Dish Table	17
SDT-16-S-96R	401664	Soiled Dish Table	17
SDT-16-U-52L	--	Soiled Dish Table	20
SDT-16-U-52R	--	Soiled Dish Table	20
SDT-16-U-60L	--	Soiled Dish Table	20
SDT-16-U-60R	--	Soiled Dish Table	20
SDT-16-U-72L	--	Soiled Dish Table	20
SDT-16-U-72R	--	Soiled Dish Table	20
SMC-63	102411	HD Sani-Mobile Cooler Cart	89
SN-2618	104424	Lug, Gray Polyethylene	129
SRC-58/3Z	112483	Bakery Rack Cover	132
SRC-58FC/3Z	157041	Bakery Rack Cover	132
SS-1010	103974	Platter Cart, Stainless Steel	96
SS-1012	103982	Platter Cart, Stainless Steel	96
SS-106	104002	Half Size Platter Cart, SS	96
SS-1210	104011	Platter Cart, Stainless Steel	96
SS-1212	104029	Platter Cart, Stainless Steel	96
SS-126	104053	Half Size Platter Cart, SS	96
SS-1810B	110470	Heavy Duty Pan Rack, SS	57
SS-1810N	289140	Nesting Pan Rack	56
SS-1812B	110488	Heavy Duty Pan Rack, SS	57
SS-1818B	110525	Heavy Duty Pan Rack, SS	57
SS-1820B	110541	Heavy Duty Pan Rack, SS	57
SS-1820N	289158	Nesting Pan Rack	56
SS-1830B	110568	Heavy Duty Pan Rack, SS	57
SS-186	104088	Half Size Platter Cart, SS	96
SS-2610B	110584	Heavy Duty Pan Rack, SS	57
SS-2618B	156339	Heavy Duty Pan Rack, SS	57
SS-2620B	110605	Heavy Duty Pan Rack, SS	57
SSCMPR-10816	--	Ceiling Mount Pot Rack	45
SSCMPR-12016	--	Ceiling Mount Pot Rack	45
SSCMPR-13216	--	Ceiling Mount Pot Rack	45
SSCMPR-14416	946648	Ceiling Mount Pot Rack	45
SSCMPR-3616	--	Ceiling Mount Pot Rack	45
SSCMPR-4816	683972	Ceiling Mount Pot Rack	45
SSCMPR-6016	683981	Ceiling Mount Pot Rack	45
SSCMPR-7216	683999	Ceiling Mount Pot Rack	45
SSCMPR-8416	684001	Ceiling Mount Pot Rack	45
SSCMPR-9616	--	Ceiling Mount Pot Rack	45
SSIC-1544-3S	378521	Icing Cart	99
SS-L-1	104310	SS Lug Cart, Capacity 1 lug	94
SS-L-2	104336	SS Lug Cart, Cap. 2 Lugs	94
SS-L-3	104361	SS Lug Cart, Cap. 3 Lugs	94
SS-L-6	104387	Lug Cart, Cap. 6 Lugs	94
SSMDTXXXX/DBL	--	Sorting Shelf Double Table Mount per linear foot	21
SSMI2T-4-59/2MLC	992530	Insulated Display	98
SSMIT-3636MLC/CAN/ADJ	982745	Insulated Adjustable Display Table	99
SSMIT-4848-MLC-SNG-KIT	688167	Insulated Table Display	98
SSMS-1824	489213	Microwave Wall Shelf	45
SSMS-2424	187418	Microwave Wall Shelf	45
SSPR-1320	382408	Steam Pan Rack	56
SSPT-18108	--	Single Pass-Thru Shelf	45
SSPT-18120	--	Single Pass-Thru Shelf	45
SSPT-18132	--	Single Pass-Thru Shelf	45
SSPT-18144	--	Single Pass-Thru Shelf	45

Model Number	Order#	Product Description	Page#
SSPT-1848	--	Single Pass-Thru Shelf	45
SSPT-1860	--	Single Pass-Thru Shelf	45
SSPT-1872	--	Single Pass-Thru Shelf	45
SSPT-1884	--	Single Pass-Thru Shelf	45
SSPT-1896	--	Single Pass-Thru Shelf	45
SSPT-24108	--	Single Pass-Thru Shelf	45
SSPT-24120	971481	Single Pass-Thru Shelf	45
SSPT-24132	--	Single Pass-Thru Shelf	45
SSPT-24144	--	Single Pass-Thru Shelf	45
SSPT-2448	--	Single Pass-Thru Shelf	45
SSPT-2460	--	Single Pass-Thru Shelf	45
SSPT-2472	--	Single Pass-Thru Shelf	45
SSPT-2484	--	Single Pass-Thru Shelf	45
SSPT-2496	687375	Single Pass-Thru Shelf	45
SSSC-3624MSD	210121	SS Demo Table	102
SSTMDS-10108	--	Double Over Shelves Table Mount	40
SSTMDS-10120	--	Double Over Shelves Table Mount	40
SSTMDS-10132	--	Double Over Shelves Table Mount	40
SSTMDS-10144	--	Double Over Shelves Table Mount	40
SSTMDS-1036	--	Double Over Shelves Table Mount	40
SSTMDS-1048	--	Double Over Shelves Table Mount	40
SSTMDS-1060	--	Double Over Shelves Table Mount	40
SSTMDS-1072	--	Double Over Shelves Table Mount	40
SSTMDS-1084	--	Double Over Shelves Table Mount	40
SSTMDS-1096	--	Double Over Shelves Table Mount	40
SSTMDS-12108	--	Double Over Shelves Table Mount	40
SSTMDS-12120	--	Double Over Shelves Table Mount	40
SSTMDS-12132	--	Double Over Shelves Table Mount	40
SSTMDS-12144	--	Double Over Shelves Table Mount	40
SSTMDS-1236	--	Double Over Shelves Table Mount	40
SSTMDS-1248	--	Double Over Shelves Table Mount	40
SSTMDS-1260	--	Double Over Shelves Table Mount	40
SSTMDS-1272	--	Double Over Shelves Table Mount	40
SSTMDS-1284	--	Double Over Shelves Table Mount	40
SSTMDS-1296	--	Double Over Shelves Table Mount	40
SSTMDS-15108	--	Double Over Shelves Table Mount	40
SSTMDS-15120	--	Double Over Shelves Table Mount	40
SSTMDS-15132	--	Double Over Shelves Table Mount	40
SSTMDS-15144	--	Double Over Shelves Table Mount	40
SSTMDS-1536	--	Double Over Shelves Table Mount	40
SSTMDS-1548	--	Double Over Shelves Table Mount	40

Model Number	Order#	Product Description	Page#
SSTMDS-1560	--	Double Over Shelves Table Mount	40
SSTMDS-1572	--	Double Over Shelves Table Mount	40
SSTMDS-1584	--	Double Over Shelves Table Mount	40
SSTMDS-1596	--	Double Over Shelves Table Mount	40
SSTMS-10108	--	Single Over Shelf Table Mount	40
SSTMS-10120	--	Single Over Shelf Table Mount	40
SSTMS-10132	--	Single Over Shelf Table Mount	40
SSTMS-10144	--	Single Over Shelf Table Mount	40
SSTMS-1036	--	Single Over Shelf Table Mount	40
SSTMS-1048	--	Single Over Shelf Table Mount	40
SSTMS-1060	--	Single Over Shelf Table Mount	40
SSTMS-1072	--	Single Over Shelf Table Mount	40
SSTMS-1084	--	Single Over Shelf Table Mount	40
SSTMS-1096	--	Single Over Shelf Table Mount	40
SSTMS-12108	--	Single Over Shelf Table Mount	40
SSTMS-12120	--	Single Over Shelf Table Mount	40
SSTMS-12132	--	Single Over Shelf Table Mount	40
SSTMS-12144	--	Single Over Shelf Table Mount	40
SSTMS-1236	--	Single Over Shelf Table Mount	40
SSTMS-1248	--	Single Over Shelf Table Mount	40
SSTMS-1260	--	Single Over Shelf Table Mount	40
SSTMS-1272	--	Single Over Shelf Table Mount	40
SSTMS-1284	--	Single Over Shelf Table Mount	40
SSTMS-1296	--	Single Over Shelf Table Mount	40
SSTMS-15108	--	Single Over Shelf Table Mount	40
SSTMS-15120	--	Single Over Shelf Table Mount	40
SSTMS-15132	--	Single Over Shelf Table Mount	40
SSTMS-15144	--	Single Over Shelf Table Mount	40
SSTMS-1536	--	Single Over Shelf Table Mount	40
SSTMS-1548	--	Single Over Shelf Table Mount	40
SSTMS-1560	--	Single Over Shelf Table Mount	40
SSTMS-1572	--	Single Over Shelf Table Mount	40
SSTMS-1584	--	Single Over Shelf Table Mount	40
SSTMS-1596	--	Single Over Shelf Table Mount	40
SSWMS122/KD	642100	KD Wall Mounted Shelf	44

Model Number	Order#	Product Description	Page#
SSWMS123	185711	Wall Mounted Shelf	44
SSWMS123/KD	642118	KD Wall Mounted Shelf	44
SSWMS124	112803	Wall Mounted Shelf	44
SSWMS124/KD	642126	KD Wall Mounted Shelf	44
SSWMS125	136258	Wall Mounted Shelf	44
SSWMS125/KD	642134	KD Wall Mounted Shelf	44
SSWMS126	143407	Wall Mounted Shelf	44
SSWMS127	417594	Wall Mounted Shelf	44
SSWMS128	142754	Wall Mounted Shelf	44
SSWMS129	442212	Wall Mounted Shelf	44
SSWMS1510	417746	Wall Mounted Shelf	44
SSWMS1511	--	Wall Mounted Shelf	44
SSWMS1512	--	Wall Mounted Shelf	44
SSWMS152	417631	Wall Mounted Shelf	44
SSWMS153	417640	Wall Mounted Shelf	44
SSWMS154	417658	Wall Mounted Shelf	44
SSWMS155	417682	Wall Mounted Shelf	44
SSWMS156	417691	Wall Mounted Shelf	44
SSWMS157	417720	Wall Mounted Shelf	44
SSWMS158	417738	Wall Mounted Shelf	44
SSWMS159	617596	Wall Mounted Shelf	44
SSWMSH07	417480	Wall Mt Shelf w/Pot Hooks	44
SSWMSH1010	163512	Wall Mt Shelf w/Pot Hooks	44
SSWMSH1011	--	Wall Mt Shelf w/Pot Hooks	44
SSWMSH1012	--	Wall Mt Shelf w/Pot Hooks	44
SSWMSH102	417439	Wall Mt Shelf w/Pot Hooks	44
SSWMSH103	417447	Wall Mt Shelf w/Pot Hooks	44
SSWMSH104	164620	Wall Mt Shelf w/Pot Hooks	44
SSWMSH105	155125	Wall Mt Shelf w/Pot Hooks	44
SSWMSH106	164638	Wall Mt Shelf w/Pot Hooks	44
SSWMSH108	417501	Wall Mt Shelf w/Pot Hooks	44
SSWMSH109	--	Wall Mt Shelf w/Pot Hooks	44
SSWMSH1210	172081	Wall Mt Shelf w/Pot Hooks	44
SSWMSH1211	--	Wall Mt Shelf w/Pot Hooks	44
SSWMSH122	417607	Wall Mt Shelf w/Pot Hooks	44
SSWMSH122	417607	Wall Mt Shelf w/Pot Hooks	44
SSWMSH123	417623	Wall Mt Shelf w/Pot Hooks	44
SSWMSH124	112854	Wall Mt Shelf w/Pot Hooks	44
SSWMSH125	164929	Wall Mt Shelf w/Pot Hooks	44
SSWMSH126	112862	Wall Mt Shelf w/Pot Hooks	44
SSWMSH127	397538	Wall Mt Shelf w/Pot Hooks	44
SSWMSH128	128039	Wall Mt Shelf w/Pot Hooks	44
SSWMSH129	--	Wall Mt Shelf w/Pot Hooks	44
SSWMSH1510	417922	Wall Mt Shelf w/Pot Hooks	44
SSWMSH1511	--	Wall Mt Shelf w/Pot Hooks	44
SSWMSH1512	--	Wall Mt Shelf w/Pot Hooks	44
SSWMSH152	417762	Wall Mt Shelf w/Pot Hooks	44
SSWMSH153	417771	Wall Mt Shelf w/Pot Hooks	44
SSWMSH154	417789	Wall Mt Shelf w/Pot Hooks	44
SSWMSH155	417797	Wall Mt Shelf w/Pot Hooks	44
SSWMSH156	417893	Wall Mt Shelf w/Pot Hooks	44
SSWMSH157	444568	Wall Mt Shelf w/Pot Hooks	44
SSWMSH158	444550	Wall Mt Shelf w/Pot Hooks	44
SSWMSH159	--	Wall Mt Shelf w/Pot Hooks	44
ST	Option	Option - Solid Top EXTRA HD Pan & Universal Racks	50 & 52
ST-3-SRC-1110-IW	996881	Roll Cage Three Sides	122
ST-3-SRC-8080-IW	996899	Roll Cage Three Sides	122
STCT-15108-DC	--	Dish Cabinet	41
STCT-15120-DC	--	Dish Cabinet	41
STCT-15144-DC	--	Dish Cabinet	41
STCT-1548-DC	--	Dish Cabinet	41

Model Number	Order#	Product Description	Page#
STCT-1560-DC	694621	Dish Cabinet	41
STCT-1572-DC	--	Dish Cabinet	41
STCT-1584-DC	--	Dish Cabinet	41
STCT-1596-DC	--	Dish Cabinet	41
STCT-18108-DC	972424	Dish Cabinet	41
STCT-18120-DC	--	Dish Cabinet	41
STCT-18144-DC	--	Dish Cabinet	41
STCT-1848-DC	694612	Dish Cabinet	41
STCT-1860-DC	--	Dish Cabinet	41
STCT-1872-DC	--	Dish Cabinet	41
STCT-1884-DC	--	Dish Cabinet	41
STCT-1896-DC	--	Dish Cabinet	41
STCT-24108	--	Enclosed Base Table	32
STCT-24108/MS	--	Enclosed Base Table	32
STCT-24120	--	Enclosed Base Table	32
STCT-24120/MS	--	Enclosed Base Table	32
STCT-24144	--	Enclosed Base Table	32
STCT-24144/MS	--	Enclosed Base Table	32
STCT-2436	676457	Enclosed Base Table F1166	32
STCT-2436/MS	--	Enclosed Base Table	32
STCT-2448	676465	Enclosed Base Table	32
STCT-2448/MS	--	Enclosed Base Table	32
STCT-2460	676473	Enclosed Base Table	32
STCT-2460/MS	--	Enclosed Base Table	32
STCT-2472	676481	Enclosed Base Table	32
STCT-2472/MS	--	Enclosed Base Table	32
STCT-2484	676490	Enclosed Base Table	32
STCT-2484./MS	--	Enclosed Base Table	32
STCT-2496	676502	Enclosed Base Table	32
STCT-2496/MS	681441	Enclosed Base Table	32
STCT-30108	--	Enclosed Base Table	32
STCT-30108/MS	--	Enclosed Base Table	32
STCT-30120	--	Enclosed Base Table	32
STCT-30120/MS	--	Enclosed Base Table	32
STCT-30144	--	Enclosed Base Table	32
STCT-30144/MS	--	Enclosed Base Table	32
STCT-3036	676511	Enclosed Base Table	32
STCT-3036/MS	640251	Enclosed Base Table	32
STCT-3048	676529	Enclosed Base Table	32
STCT-3048/MS	640155	Enclosed Base Table	32
STCT-3060	422781	Enclosed Base Table	32
STCT-3060/MS	422799	Enclosed Base Table	32
STCT-3072	133284	Enclosed Base Table	32
STCT-3072/MS	640243	Enclosed Base Table	32
STCT-3084	676537	Enclosed Base Table	32
STCT-3084/MS	640235	Enclosed Base Table	32
STCT-3096	113793	Enclosed Base Table	32
STCT-3096/MS	635938	Enclosed Base Table	32
STCT-36108	--	Enclosed Base Table	32
STCT-36108/MS	--	Enclosed Base Table	32
STCT-36120	--	Enclosed Base Table	32
STCT-36120/MS	--	Enclosed Base Table	32
STCT-36144	--	Enclosed Base Table	32
STCT-36144/MS	--	Enclosed Base Table	32
STCT-3615-WMO	--	Wall Mount Cabinets	46
STCT-3636	--	Enclosed Base Table	32
STCT-3636/MS	659673	Enclosed Base Table	32
STCT-3648	655533	Enclosed Base Table	32
STCT-3648/MS	--	Enclosed Base Table	32
STCT-3660	--	Enclosed Base Table	32
STCT-3660/MS	624307	Enclosed Base Table	32
STCT-3672	655541	Enclosed Base Table	32

Model Number	Order#	Product Description	Page#
STCT-3672/MS	--	Enclosed Base Table	32
STCT-3684	--	Enclosed Base Table	32
STCT-3684/MS	--	Enclosed Base Table	32
STCT-3696	--	Enclosed Base Table	32
STCT-3696/MS	--	Enclosed Base Table	32
STCT-4815-WMO	--	Wall Mount Cabinets	46
STCT-6015-WMO	--	Wall Mount Cabinets	46
STCT-B1.5-24108	--	Enclosed Table 1.5" Backsplash	34
STCT-B1.5-24108/MS	--	Enclosed Base Table 1.5" Backsplash	34
STCT-B1.5-24120	--	Enclosed Base Table 1.5" Backsplash	34
STCT-B1.5-24120/MS	--	Enclosed Base Table 1.5" Backsplash	34
STCT-B1.5-24144	--	Enclosed Base Table 1.5" Backsplash	34
STCT-B1.5-24144	--	Enclosed Base Table 1.5" Backsplash	34
STCT-B1.5-24144/MS	--	Enclosed Base Table 1.5" Backsplash	34
STCT-B1.5-24144/MS	--	Enclosed Base Table 1.5" Backsplash	34
STCT-B1.5-2436	--	Enclosed Base Table 1.5" Backsplash	34
STCT-B1.5-2436/MS	--	Enclosed Base Table 1.5" Backsplash	34
STCT-B1.5-2448	--	Enclosed Base Table 1.5" Backsplash	34
STCT-B1.5-2448/MS	--	Enclosed Base Table 1.5" Backsplash	34
STCT-B1.5-2460	--	Enclosed Base Table 1.5" Backsplash	34
STCT-B1.5-2460/MS	--	Enclosed Base Table 1.5" Backsplash	34
STCT-B1.5-2472	--	Enclosed Base Table 1.5" Backsplash	34
STCT-B1.5-2472/MS	--	Enclosed Base Table 1.5" Backsplash	34
STCT-B1.5-2484	--	Enclosed Base Table 1.5" Backsplash	34
STCT-B1.5-2484/MS	--	Enclosed Base Table 1.5" Backsplash	34
STCT-B1.5-2496	--	Enclosed Base Table 1.5" Backsplash	34
STCT-B1.5-2496/MS	--	Enclosed Base Table 1.5" Backsplash	34
STCT-B1.5-30108	--	Enclosed Base Table 1.5" Backsplash	34
STCT-B1.5-30108/MS	--	Enclosed Base Table 1.5" Backsplash	34
STCT-B1.5-30120	--	Enclosed Base Table 1.5" Backsplash	34
STCT-B1.5-30120/MS	--	Enclosed Base Table 1.5" Backsplash	34
STCT-B1.5-3036	--	Enclosed Base Table 1.5" Backsplash	34
STCT-B1.5-3036/MS	--	Enclosed Base Table 1.5" Backsplash	34
STCT-B1.5-3048	--	Enclosed Base Table 1.5" Backsplash	34
STCT-B1.5-3048/MS	--	Enclosed Base Table 1.5" Backsplash	34
STCT-B1.5-3060	--	Enclosed Base Table 1.5" Backsplash	34
STCT-B1.5-3060/MS	--	Enclosed Base Table 1.5" Backsplash	34
STCT-B1.5-3072	--	Enclosed Base Table 1.5" Backsplash	34

Model Number	Order#	Product Description	Page#
STCT-B1.5-3072/MS	--	Enclosed Base Table 1.5" Backsplash	34
STCT-B1.5-3084	--	Enclosed Base Table 1.5" Backsplash	34
STCT-B1.5-3084	--	Enclosed Base Table 1.5" Backsplash	34
STCT-B1.5-3084/MS	--	Enclosed Base Table 1.5" Backsplash	34
STCT-B1.5-3096	--	Enclosed Base Table 1.5" Backsplash	34
STCT-B1.5-3096/MS	--	Enclosed Base Table 1.5" Backsplash	34
STCT-B1.5-36108	--	Enclosed Base Table 1.5" Backsplash	34
STCT-B1.5-36108/MS	--	Enclosed Base Table 1.5" Backsplash	34
STCT-B1.5-36120	--	Enclosed Base Table 1.5" Backsplash	34
STCT-B1.5-36120/MS	--	Enclosed Base Table 1.5" Backsplash	34
STCT-B1.5-36144	--	Enclosed Base Table 1.5" Backsplash	34
STCT-B1.5-36144/MS	--	Enclosed Base Table 1.5" Backsplash	34
STCT-B1.5-3636	--	Enclosed Base Table 1.5" Backsplash	34
STCT-B1.5-3636/MS	--	Enclosed Base Table 1.5" Backsplash	34
STCT-B1.5-3648	--	Enclosed Base Table 1.5" Backsplash	34
STCT-B1.5-3648/MS	--	Enclosed Base Table 1.5" Backsplash	34
STCT-B1.5-3660	--	Enclosed Base Table 1.5" Backsplash	34
STCT-B1.5-3660/MS	--	Enclosed Base Table 1.5" Backsplash	34
STCT-B1.5-3672	--	Enclosed Base Table 1.5" Backsplash	34
STCT-B1.5-3672/MS	--	Enclosed Base Table 1.5" Backsplash	34
STCT-B1.5-3684	--	Enclosed Base Table 1.5" Backsplash	34
STCT-B1.5-3684/MS	--	Enclosed Base Table 1.5" Backsplash	34
STCT-B1.5-3696	--	Enclosed Base Table 1.5" Backsplash	34
STCT-B1.5-3696/MS	--	Enclosed Base Table 1.5" Backsplash	34
STCT-B1.5D-24108	--	Enclosed Base Table 1.5" Backsplash	34
STCT-B1.5D-24108/MS	--	Enclosed Base Table 1.5" Backsplash	34
STCT-B1.5D-24120	--	Enclosed Base Table 1.5" Backsplash	34
STCT-B1.5D-24120/MS	--	Enclosed Base Table 1.5" Backsplash	34
STCT-B1.5D-24144	--	Enclosed Base Table 1.5" Backsplash	34
STCT-B1.5D-24144	--	Enclosed Base Table 1.5" Backsplash	34
STCT-B1.5D-24144/MS	--	Enclosed Base Table 1.5" Backsplash	34
STCT-B1.5D-24144/MS	--	Enclosed Base Table 1.5" Backsplash	34
STCT-B1.5-D2448	--	Enclosed Base Table 1.5" Backsplash	34
STCT-B1.5-D2448/MS	--	Enclosed Base Table 1.5" Backsplash	34
STCT-B1.5-D2460	--	Enclosed Base Table 1.5" Backsplash	34

Model Number	Order#	Product Description	Page#
STCT-B1.5HD-3096	--	Enclosed Base Table 1.5" Backsplash	34
STCT-B1.5HD-3096/MS	--	Enclosed Base Table 1.5" Backsplash	34
STCT-B1.5HD-36108	--	Enclosed Base Table 1.5" Backsplash	34
STCT-B1.5HD-36108/MS	--	Enclosed Base Table 1.5" Backsplash	34
STCT-B1.5HD-36120	--	Enclosed Base Table 1.5" Backsplash	34
STCT-B1.5HD-36120/MS	--	Enclosed Base Table 1.5" Backsplash	34
STCT-B1.5HD-36144	--	Enclosed Base Table 1.5" Backsplash	34
STCT-B1.5HD-36144/MS	--	Enclosed Base Table 1.5" Backsplash	34
STCT-B1.5HD-3636	--	Enclosed Base Table 1.5" Backsplash	34
STCT-B1.5HD-3636/MS	--	Enclosed Base Table 1.5" Backsplash	34
STCT-B1.5HD-3648	--	Enclosed Base Table 1.5" Backsplash	34
STCT-B1.5HD-3648/MS	--	Enclosed Base Table 1.5" Backsplash	34
STCT-B1.5HD-3660	--	Enclosed Base Table 1.5" Backsplash	34
STCT-B1.5HD-3660/MS	--	Enclosed Base Table 1.5" Backsplash	34
STCT-B1.5HD-3672	--	Enclosed Base Table 1.5" Backsplash	34
STCT-B1.5HD-3672/MS	--	Enclosed Base Table 1.5" Backsplash	34
STCT-B1.5HD-3684	--	Enclosed Base Table 1.5" Backsplash	34
STCT-B1.5HD-3684/MS	--	Enclosed Base Table 1.5" Backsplash	34
STCT-B1.5HD-3696	--	Enclosed Base Table 1.5" Backsplash	34
STCT-B1.5HD-3696/MS	--	Enclosed Base Table 1.5" Backsplash	34
STCT-BB24108	--	Enclosed Base Table 5" Backsplash	33
STCT-BB24108/MS	--	Enclosed Base Table 5" Backsplash	33
STCT-BB24120	--	Enclosed Base Table 5" Backsplash	33
STCT-BB24120/MS	--	Enclosed Base Table 5" Backsplash	33
STCT-BB24144	--	Enclosed Base Table 5" Backsplash	33
STCT-BB24144/MS	--	Enclosed Base Table 5" Backsplash	33
STCT-BB2436	676457	Enclosed Base Table 5" Backsplash	33
STCT-BB2436/MS	--	Enclosed Base Table 5" Backsplash	33
STCT-BB2448	--	Enclosed Base Table 5" Backsplash	33
STCT-BB2448/MS	--	Enclosed Base Table 5" Backsplash	33
STCT-BB2460	--	Enclosed Base Table 5" Backsplash	33
STCT-BB2460/MS	--	Enclosed Base Table 5" Backsplash	33
STCT-BB2472	--	Enclosed Base Table 5" Backsplash	33
STCT-BB2472/MS	--	Enclosed Base Table 5" Backsplash	33
STCT-BB2484	--	Enclosed Base Table 5" Backsplash	33

Model Number	Order#	Product Description	Page#
STCT-BB2484/MS	--	Enclosed Base Table 5" Backsplash	33
STCT-BB2496	--	Enclosed Base Table 5" Backsplash	33
STCT-BB2496/MS	--	Enclosed Base Table 5" Backsplash	33
STCT-BB30108	--	Enclosed Base Table 5" Backsplash	33
STCT-BB30108/MS	--	Enclosed Base Table 5" Backsplash	33
STCT-BB30120	--	Enclosed Base Table 5" Backsplash	33
STCT-BB30120/MS	--	Enclosed Base Table 5" Backsplash	33
STCT-BB30144	--	Enclosed Base Table 5" Backsplash	33
STCT-BB30144/MS	--	Enclosed Base Table 5" Backsplash	33
STCT-BB3036	--	Enclosed Base Table 5" Backsplash	33
STCT-BB3036/MS	--	Enclosed Base Table 5" Backsplash	33
STCT-BB3048	--	Enclosed Base Table 5" Backsplash	33
STCT-BB3048/MS	947149	Enclosed Base Table 5" Backsplash	33
STCT-BB3060	--	Enclosed Base Table 5" Backsplash	33
STCT-BB3060/MS	--	Enclosed Base Table 5" Backsplash	33
STCT-BB3072	973283	Enclosed Base Table 5" Backsplash	33
STCT-BB3072/MS	977161	Enclosed Base Table 5" Backsplash	33
STCT-BB3084	--	Enclosed Base Table 5" Backsplash	33
STCT-BB3084/MS	--	Enclosed Base Table 5" Backsplash	33
STCT-BB3096	--	Enclosed Base Table 5" Backsplash	33
STCT-BB3096/MS	--	Enclosed Base Table 5" Backsplash	33
STCT-BB36108	--	Enclosed Base Table 5" Backsplash	33
STCT-BB36108/MS	--	Enclosed Base Table 5" Backsplash	33
STCT-BB36120	--	Enclosed Base Table 5" Backsplash	33
STCT-BB36120/MS	--	Enclosed Base Table 5" Backsplash	33
STCT-BB36144	--	Enclosed Base Table 5" Backsplash	33
STCT-BB36144/MS	--	Enclosed Base Table 5" Backsplash	33
STCT-BB3636	--	Enclosed Base Table 5" Backsplash	33
STCT-BB3636/MS	--	Enclosed Base Table 5" Backsplash	33
STCT-BB3648	--	Enclosed Base Table 5" Backsplash	33
STCT-BB3648/MS	--	Enclosed Base Table 5" Backsplash	33
STCT-BB3660	--	Enclosed Base Table 5" Backsplash	33
STCT-BB3660/MS	--	Enclosed Base Table 5" Backsplash	33
STCT-BB3672	--	Enclosed Base Table 5" Backsplash	33
STCT-BB3672/MS	--	Enclosed Base Table 5" Backsplash	33

Model Number	Order#	Product Description	Page#
STCT-BB3684	--	Enclosed Base Table 5" Backsplash	33
STCT-BB3684/MS	--	Enclosed Base Table 5" Backsplash	33
STCT-BB3696	--	Enclosed Base Table 5" Backsplash	33
STCT-BB3696/MS	--	Enclosed Base Table 5" Backsplash	33
STCT-BBD24108	--	Enclosed Base Table 5" Backsplash	33
STCT-BBD24108/MS	--	Enclosed Base Table 5" Backsplash	33
STCT-BBD24120	--	Enclosed Base Table 5" Backsplash	33
STCT-BBD24120/MS	--	Enclosed Base Table 5" Backsplash	33
STCT-BBD24144	--	Enclosed Base Table 5" Backsplash	33
STCT-BBD24144/MS	--	Enclosed Base Table 5" Backsplash	33
STCT-BBD2448	676342	Enclosed Base Table 5" Backsplash	33
STCT-BBD2448/MS	--	Enclosed Base Table 5" Backsplash	33
STCT-BBD2460	676351	Enclosed Base Table 5" Backsplash	33
STCT-BBD2460/MS	--	Enclosed Base Table 5" Backsplash	33
STCT-BBD2472	--	Enclosed Base Table 5" Backsplash	33
STCT-BBD2472/MS	--	Enclosed Base Table 5" Backsplash	33
STCT-BBD2484	676377	Enclosed Base Table 5" Backsplash	33
STCT-BBD2484./MS	--	Enclosed Base Table 5" Backsplash	33
STCT-BBD2496	676385	Enclosed Base Table 5" Backsplash	33
STCT-BBD30108	--	Enclosed Base Table 5" Backsplash	33
STCT-BBD30108/MS	--	Enclosed Base Table 5" Backsplash	33
STCT-BBD30120	--	Enclosed Base Table 5" Backsplash	33
STCT-BBD30120/MS	--	Enclosed Base Table 5" Backsplash	33
STCT-BBD30144	--	Enclosed Base Table 5" Backsplash	33
STCT-BBD30144/MS	--	Enclosed Base Table 5" Backsplash	33
STCT-BBD3048	--	Enclosed Base Table 5" Backsplash	33
STCT-BBD3048/MS	--	Enclosed Base Table 5" Backsplash	33
STCT-BBD3060	--	Enclosed Base Table 5" Backsplash	33
STCT-BBD3060/MS	--	Enclosed Base Table 5" Backsplash	33
STCT-BBD3072	--	Enclosed Base Table 5" Backsplash	33
STCT-BBD3072/MS	971552	Enclosed Base Table 5" Backsplash	33
STCT-BBD3084	--	Enclosed Base Table 5" Backsplash	33
STCT-BBD3084/MS	--	Enclosed Base Table 5" Backsplash	33
STCT-BBD3096	--	Enclosed Base Table 5" Backsplash	33
STCT-BBD3096/MS	--	Enclosed Base Table 5" Backsplash	33

Model Number	Order#	Product Description	Page#
STCT-BBD36108	--	Enclosed Base Table 5" Backsplash	33
STCT-BBD36108/MS	--	Enclosed Base Table 5" Backsplash	33
STCT-BBD36120	--	Enclosed Base Table 5" Backsplash	33
STCT-BBD36120/MS	--	Enclosed Base Table 5" Backsplash	33
STCT-BBD36144	--	Enclosed Base Table 5" Backsplash	33
STCT-BBD36144/MS	--	Enclosed Base Table 5" Backsplash	33
STCT-BBD3648	--	Enclosed Base Table 5" Backsplash	33
STCT-BBD3648/MS	--	Enclosed Base Table 5" Backsplash	33
STCT-BBD3660	--	Enclosed Base Table 5" Backsplash	33
STCT-BBD3660/MS	--	Enclosed Base Table 5" Backsplash	33
STCT-BBD3672	--	Enclosed Base Table 5" Backsplash	33
STCT-BBD3672/MS	--	Enclosed Base Table 5" Backsplash	33
STCT-BBD3684	--	Enclosed Base Table 5" Backsplash	33
STCT-BBD3684/MS	--	Enclosed Base Table 5" Backsplash	33
STCT-BBD3696	--	Enclosed Base Table 5" Backsplash	33
STCT-BBD3696/MS	--	Enclosed Base Table 5" Backsplash	33
STCT-BBD496/MS	--	Enclosed Base Table 5" Backsplash	33
STCT-BBHD24108	--	Enclosed Base Table 5" Backsplash	33
STCT-BBHD24108/MS	--	Enclosed Base Table 5" Backsplash	33
STCT-BBHD24120	--	Enclosed Base Table 5" Backsplash	33
STCT-BBHD24120/MS	--	Enclosed Base Table 5" Backsplash	33
STCT-BBHD24144	--	Enclosed Base Table 5" Backsplash	33
STCT-BBHD24144/MS	--	Enclosed Base Table 5" Backsplash	33
STCT-BBHD2436	--	Enclosed Base Table 5" Backsplash	33
STCT-BBHD2436	--	Enclosed Base Table 5" Backsplash	33
STCT-BBHD2436/MS	--	Enclosed Base Table 5" Backsplash	33
STCT-BBHD2448/MS	--	Enclosed Base Table 5" Backsplash	33
STCT-BBHD2460	--	Enclosed Base Table 5" Backsplash	33
STCT-BBHD2460/MS	--	Enclosed Base Table 5" Backsplash	33
STCT-BBHD2472	--	Enclosed Base Table 5" Backsplash	33
STCT-BBHD2472/MS	--	Enclosed Base Table 5" Backsplash	33
STCT-BBHD2484	--	Enclosed Base Table 5" Backsplash	33
STCT-BBHD2484./MS	--	Enclosed Base Table 5" Backsplash	33
STCT-BBHD2496	--	Enclosed Base Table 5" Backsplash	33
STCT-BBHD2496/MS	--	Enclosed Base Table 5" Backsplash	33

Model Number	Order#	Product Description	Page#
STCT-BBHD30108	--	Enclosed Base Table 5" Backsplash	33
STCT-BBHD30108/MS	--	Enclosed Base Table 5" Backsplash	33
STCT-BBHD30120	--	Enclosed Base Table 5" Backsplash	33
STCT-BBHD30120/MS	--	Enclosed Base Table 5" Backsplash	33
STCT-BBHD30144	--	Enclosed Base Table 5" Backsplash	33
STCT-BBHD30144/MS	--	Enclosed Base Table 5" Backsplash	33
STCT-BBHD3036	--	Enclosed Base Table 5" Backsplash	33
STCT-BBHD3036/MS	--	Enclosed Base Table 5" Backsplash	33
STCT-BBHD3048	--	Enclosed Base Table 5" Backsplash	33
STCT-BBHD3048/MS	--	Enclosed Base Table 5" Backsplash	33
STCT-BBHD3060	--	Enclosed Base Table 5" Backsplash	33
STCT-BBHD3060/MS	--	Enclosed Base Table 5" Backsplash	33
STCT-BBHD3072	--	Enclosed Base Table 5" Backsplash	33
STCT-BBHD3072/MS	--	Enclosed Base Table 5" Backsplash	33
STCT-BBHD3084	--	Enclosed Base Table 5" Backsplash	33
STCT-BBHD3084/MS	--	Enclosed Base Table 5" Backsplash	33
STCT-BBHD3096	--	Enclosed Base Table 5" Backsplash	33
STCT-BBHD3096/MS	--	Enclosed Base Table 5" Backsplash	33
STCT-BBHD36108	--	Enclosed Base Table 5" Backsplash	33
STCT-BBHD36108/MS	--	Enclosed Base Table 5" Backsplash	33
STCT-BBHD36120	--	Enclosed Base Table 5" Backsplash	33
STCT-BBHD36120/MS	--	Enclosed Base Table 5" Backsplash	33
STCT-BBHD36144	--	Enclosed Base Table 5" Backsplash	33
STCT-BBHD36144/MS	--	Enclosed Base Table 5" Backsplash	33
STCT-BBHD3636	--	Enclosed Base Table 5" Backsplash	33
STCT-BBHD3636/MS	--	Enclosed Base Table 5" Backsplash	33
STCT-BBHD3648	--	Enclosed Base Table 5" Backsplash	33
STCT-BBHD3648/MS	--	Enclosed Base Table 5" Backsplash	33
STCT-BBHD3660	--	Enclosed Base Table 5" Backsplash	33
STCT-BBHD3660/MS	--	Enclosed Base Table 5" Backsplash	33
STCT-BBHD3684	--	Enclosed Base Table 5" Backsplash	33
STCT-BBHD3684/MS	--	Enclosed Base Table 5" Backsplash	33
STCT-BBHD3696	--	Enclosed Base Table 5" Backsplash	33
STCT-BBHD3696/MS	--	Enclosed Base Table 5" Backsplash	33
STCT-BBHD3672	--	Enclosed Base Table 5" Backsplash	33

Model Number	Order#	Product Description	Page#
STCT-BBHD3672/MS	--	Enclosed Base Table 5" Backsplash	33
STCT-BC-30108-L	--	Beverage Counter	41
STCT-BC-30108-R	--	Beverage Counter	41
STCT-BC-30120-L	--	Beverage Counter	41
STCT-BC-30120-R	--	Beverage Counter	41
STCT-BC-30144-L	--	Beverage Counter	41
STCT-BC-30144-R	--	Beverage Counter	41
STCT-BC-3048-L	982770	Beverage Counter	41
STCT-BC-3048-R	--	Beverage Counter	41
STCT-BC-3060-L	--	Beverage Counter	41
STCT-BC-3060-R	--	Beverage Counter	41
STCT-BC-3072-L	--	Beverage Counter	41
STCT-BC-3072-R	--	Beverage Counter	41
STCT-BC-3084-L	--	Beverage Counter	41
STCT-BC-3084-R	--	Beverage Counter	41
STCT-BC-3096-L	--	Beverage Counter	41
STCT-BC-3096-R	--	Beverage Counter	41
STCT-BC-GS-30108-L	--	Beverage Counter	41
STCT-BC-GS-30108-R	--	Beverage Counter	41
STCT-BC-GS-30120-L	--	Beverage Counter	41
STCT-BC-GS-30120-R	--	Beverage Counter	41
STCT-BC-GS-30144-L	--	Beverage Counter	41
STCT-BC-GS-30144-R	--	Beverage Counter	41
STCT-BC-GS-3048-L	--	Beverage Counter	41
STCT-BC-GS-3048-R	--	Beverage Counter	41
STCT-BC-GS3060-L	--	Beverage Counter	41
STCT-BC-GS-3072-L	--	Beverage Counter	41
STCT-BC-GS-3072-R	--	Beverage Counter	41
STCT-BC-GS-3084-L	--	Beverage Counter	41
STCT-BC-GS-3084-R	--	Beverage Counter	41
STCT-BC-GS-3096-L	--	Beverage Counter	41
STCT-BC-GS-3096-R	--	Beverage Counter	41
STCT-BD2436	132839	Stainless Steel Enclosed Base Tables -Standard	29
STCT-BD2448	162481	Stainless Steel Enclosed Base Tables -Standard	29
STCT-BD2460	113611	Stainless Steel Enclosed Base Tables -Standard	29
STCT-BD2472	113620	Stainless Steel Enclosed Base Tables -Standard	29
STCT-BD2484	162499	Stainless Steel Enclosed Base Tables -Standard	29
STCT-BD2496	113638	Stainless Steel Enclosed Base Tables -Standard	29
STCT-BD3036	140126	Stainless Steel Enclosed Base Tables -Standard	29
STCT-BD3048	113646	Stainless Steel Enclosed Base Tables -Standard	29
STCT-BD3060	113662	Stainless Steel Enclosed Base Tables -Standard	29
STCT-BD3072	113671	Stainless Steel Enclosed Base Tables -Standard	29
STCT-BD3084	131967	Stainless Steel Enclosed Base Tables -Standard	29
STCT-BD3096	113697	Stainless Steel Enclosed Base Tables -Standard	29
STCT-D24108	--	Enclosed Base Table	32
STCT-D24108/MS	--	Enclosed Base Table	32
STCT-D24120	--	Enclosed Base Table	32
STCT-D24120/MS	--	Enclosed Base Table	32
STCT-D24144	--	Enclosed Base Table	32
STCT-D24144/MS	--	Enclosed Base Table	32
STCT-D2448	172857	Enclosed Base Table	32

Model Number	Order#	Product Description	Page#
STCT-D2448/MS	--	Enclosed Base Table	32
STCT-D2460	--	Enclosed Base Table	32
STCT-D2460/MS	--	Enclosed Base Table	32
STCT-D2472	--	Enclosed Base Table	32
STCT-D2472/MS	270676	Enclosed Base Table	32
STCT-D2484	--	Enclosed Base Table	32
STCT-D2484./MS	--	Enclosed Base Table	32
STCT-D2496	--	Enclosed Base Table	32
STCT-D2496/MS	--	Enclosed Base Table	32
STCT-D30108	--	Enclosed Base Table	32
STCT-D30108/MS	--	Enclosed Base Table	32
STCT-D30120	143714	Enclosed Base Table	32
STCT-D30120/MS	--	Enclosed Base Table	32
STCT-D30144	--	Enclosed Base Table	32
STCT-D30144/MS	--	Enclosed Base Table	32
STCT-D3048	--	Enclosed Base Table	32
STCT-D3048/MS	425316	Enclosed Base Table	32
STCT-D3060	--	Enclosed Base Table	32
STCT-D3060/MS	606491	Enclosed Base Table	32
STCT-D3072	134391	Enclosed Base Table	32
STCT-D3072/MS	444200	Enclosed Base Table	32
STCT-D3084	--	Enclosed Base Table	32
STCT-D3084/MS	--	Enclosed Base Table	32
STCT-D3096	--	Enclosed Base Table	32
STCT-D3096/MS	678170	Enclosed Base Table	32
STCT-D36108	--	Enclosed Base Table	32
STCT-D36108/MS	--	Enclosed Base Table	32
STCT-D36120	--	Enclosed Base Table	32
STCT-D36120/MS	--	Enclosed Base Table	32
STCT-D36144	--	Enclosed Base Table	32
STCT-D36144/MS	--	Enclosed Base Table	32
STCT-D3648	--	Enclosed Base Table	32
STCT-D3648/MS	--	Enclosed Base Table	32
STCT-D3660	--	Enclosed Base Table	32
STCT-D3660/MS	265463	Enclosed Base Table	32
STCT-D3672	--	Enclosed Base Table	32
STCT-D3672/MS	444154	Enclosed Base Table	32
STCT-D3684	--	Enclosed Base Table	32
STCT-D3684/MS	--	Enclosed Base Table	32
STCT-D3696	--	Enclosed Base Table	32
STCT-D3696/MS	--	Enclosed Base Table	32
STCT-D4815-WMS	--	Wall Mount Cabinets	46
STCT-D6015-WMS	--	Wall Mount Cabinets	46
STCT-HD24108	--	Enclosed Base Table	32
STCT-HD24108/MS	--	Enclosed Base Table	32
STCT-HD24120	--	Enclosed Base Table	32
STCT-HD24120/MS	--	Enclosed Base Table	32
STCT-HD24144	--	Enclosed Base Table	32
STCT-HD24144/MS	--	Enclosed Base Table	32
STCT-HD2436	--	Enclosed Base Table	32
STCT-HD2436	--	Enclosed Base Table	32
STCT-HD2436/MS	--	Enclosed Base Table	32
STCT-HD2448	--	Enclosed Base Table	32
STCT-HD2448/MS	--	Enclosed Base Table	32
STCT-HD2460	--	Enclosed Base Table	32
STCT-HD2460/MS	--	Enclosed Base Table	32
STCT-HD2472	--	Enclosed Base Table	32
STCT-HD2472/MS	--	Enclosed Base Table	32
STCT-HD2484	--	Enclosed Base Table	32
STCT-HD2484./MS	--	Enclosed Base Table	32
STCT-HD2496	--	Enclosed Base Table	32
STCT-HD2496/MS	--	Enclosed Base Table	32

Model Number	Order#	Product Description	Page#
STCT-HD30108	--	Enclosed Base Table	32
STCT-HD30108/MS	--	Enclosed Base Table	32
STCT-HD30120	--	Enclosed Base Table	32
STCT-HD30120/MS	--	Enclosed Base Table	32
STCT-HD30144	--	Enclosed Base Table	32
STCT-HD30144/MS	--	Enclosed Base Table	32
STCT-HD3036	--	Enclosed Base Table	32
STCT-HD3036/MS	--	Enclosed Base Table	32
STCT-HD3048	--	Enclosed Base Table	32
STCT-HD3048/MS	--	Enclosed Base Table	32
STCT-HD3060	--	Enclosed Base Table	32
STCT-HD3060/MS	--	Enclosed Base Table	32
STCT-HD3072	--	Enclosed Base Table	32
STCT-HD3072/MS	--	Enclosed Base Table	32
STCT-HD3084	--	Enclosed Base Table	32
STCT-HD3084/MS	--	Enclosed Base Table	32
STCT-HD3096	--	Enclosed Base Table	32
STCT-HD3096/MS	--	Enclosed Base Table	32
STCT-HD36108	--	Enclosed Base Table	32
STCT-HD36108/MS	--	Enclosed Base Table	32
STCTHD36120	--	Enclosed Base Table	32
STCT-HD36120/MS	--	Enclosed Base Table	32
STCT-HD36144	--	Enclosed Base Table	32
STCT-HD36144/MS	--	Enclosed Base Table	32
STCT-HD3615-WMH	--	Wall Mount Cabinets	46
STCT-HD3636/MS	--	Enclosed Base Table	32
STCT-HD3648	--	Enclosed Base Table	32
STCT-HD3648/MS	--	Enclosed Base Table	32
STCT-HD3660	--	Enclosed Base Table	32
STCT-HD3660/MS	--	Enclosed Base Table	32
STCT-HD3672	--	Enclosed Base Table	32
STCT-HD3672/MS	--	Enclosed Base Table	32
STCT-HD3684	--	Enclosed Base Table	32
STCT-HD3684/MS	--	Enclosed Base Table	32
STCT-HD3696	--	Enclosed Base Table	32
STCT-HD3696/MS	--	Enclosed Base Table	32
STCT-HD4815-WMH	--	Wall Mount Cabinets	46
STCT-HD6015-WMH	--	Wall Mount Cabinets	46
ST-DCT-9161-UT	998878	e-commerce Picking Cart	120
STRC-4-7684-UKTC-B	996872	Roll Cage Four Sides	120
TBST-1837	137411	Sani-Stock Cart, T-Bar	115
TD-2428	102120	Heavy Duty Aluminum Tubular Dolly	76
TG/SS	Option	Pan Rack Option Tray Guard Stainless Steel	57
TUB-6A-BL	161146	Tub 6 Bushel, Blue	95
TUB-6A-GY	101709	Tub 6 Bushel, Gray	95
TUB-6A-RD	101717	Tub 6 Bushel, Red	95
TUB-6A-WH	101725	Tub 6 Bushel, White	95
TUB-8L-BL	101733	Tub 8 Bushel, Blue	95
TUB-8L-RD	101741	Tub 8 Bushel, Red	95
TUB-8L-WH	101750	Tub 8 Bushel, White	95
UAR-1022	389079	Universal Rack	52
UAR-1222	389108	Universal Rack	52
UAR-2022	389116	Universal Rack	52
UARE-1218	389212	Universal Rack	51
UARE-2018	389221	Universal Rack	51
UC-2-1833SS	627065	Stainless Steel Utility Cart	72
UC-2-2133SS	627081	Stainless Steel Utility Cart	72
UC-2-2149SS	627111	Stainless Steel Utility Cart	72
UC-3-1832SS	627073	Stainless Steel Utility Cart	72
UC-3-2133SS	627090	Stainless Steel Utility Cart	72
UC-3-2149SS	627102	Stainless Steel Utility Cart	72

Model Number	Order#	Product Description	Page#
UDT-16-L-48L	--	Under Counter Dish Table	20
UDT-16-L-48R	--	Under Counter Dish Table	20
UDT-16-L-60L	--	Under Counter Dish Table	20
UDT-16-L-60R	--	Under Counter Dish Table	20
UDT-16-L-72L	--	Under Counter Dish Table	20
UDT-16-L-72R	--	Under Counter Dish Table	20
UNAL-4	103616	Universal Cart	97
UNAL-5-WEG	103659	Universal Cart	97
UNAL-6	103691	Universal Cart	97
UNAL-7-32	103747	Universal Cart	97
UNAL-8	103771	Universal Cart	97
UNAL-8-WEG	103798	Universal Cart	97
VB	Option	Option - Vertical Bumper EXTRA HD Pan & Universal Racks	50 &52
W-1014	108231	Sani-Display Stand	130
W-2414	624366	Double Sani-Display Stand	130
WB18	Option	18" Wall Brackets	5
WBB1319	207677	Bagel, bread and bun basket, Level Top	127
WBB1723	207685	Bagel, bread and bun basket, Level Top	127
WBS-1432	210534	Bagel scoop	127
WH-ABS	--	WinFab Sink/Table Modification	12 & 22
WH-ABS10BB	--	WinFab Table Modification	37
WH-ABSBB	--	WinFab Table Modification	37
WH-AJUS	--	WinFab Table Modification	37
WH-ASBH	--	WinFab Table Modification	12, 22 & 37
WH-BE	--	WinFab Table Modification	37
WH-BS13	--	WinFab Table Modification	12, 22 & 37
WH-BS18	--	WinFab Table Modification	12, 22 & 37
WH-BSBB13	--	WinFab Table Modification	37
WH-BSBB18	--	WinFab Table Modification	37
WHBTT-1551	242739	Crisping Tray	95
WH-CBH	--	WinFab Sink & Table Modification	12 & 22
WH-CEO	--	WinFab Table Modification	37
WH-CNBRK	--	WinFab Sink Modification	12
WH-CNBRK	--	Dish Table Modification	22
WH-CNBRK14	--	WinFab Sink & Table Modification	12 & 22
WH-CNBRK14***	--	WinFab Sink & Table Modification	12 & 22
WH-CNRS	--	WinFab Table Modification	37
WH-COLLAR	--	WinFab Sink & Table Modification	12 & 22
WH-COLLAR14	--	WinFab Sink & Table Modification	12 & 22
WH-COS-10108	--	Work Station Shelving	39
WH-COS-10120	--	Work Station Shelving	39
WH-COS-10132	--	Work Station Shelving	39
WH-COS-10144	--	Work Station Shelving	39
WH-COS-1036	--	Work Station Shelving	39
WH-COS-1048	--	Work Station Shelving	39
WH-COS-1060	--	Work Station Shelving	39
WH-COS-1072	--	Work Station Shelving	39
WH-COS-1084	--	Work Station Shelving	39
WH-COS-1096	--	Work Station Shelving	39
WH-COS-12108	--	Work Station Shelving	39
WH-COS-12120	--	Work Station Shelving	39
WH-COS-12132	--	Work Station Shelving	39

Model Number	Order#	Product Description	Page#
WH-COS-12144	--	Work Station Shelving	39
WH-COS-1236	--	Work Station Shelving	39
WH-COS-1248	--	Work Station Shelving	39
WH-COS-1260	--	Work Station Shelving	39
WH-COS-1272	--	Work Station Shelving	39
WH-COS-1284	--	Work Station Shelving	39
WH-COS-1296	--	Work Station Shelving	39
WH-COS-15108	--	Work Station Shelving	39
WH-COS-15120	--	Work Station Shelving	39
WH-COS-15132	--	Work Station Shelving	39
WH-COS-15144	--	Work Station Shelving	39
WH-COS-1536	--	Work Station Shelving	39
WH-COS-1548	--	Work Station Shelving	39
WH-COS-1560	--	Work Station Shelving	39
WH-COS-1572	--	Work Station Shelving	39
WH-COS-1584	--	Work Station Shelving	39
WH-COS-1596	--	Work Station Shelving	39
WH-COS-18108	--	Work Station Shelving	39
WH-COS-18120	--	Work Station Shelving	39
WH-COS-18132	--	Work Station Shelving	39
WH-COS-18144	--	Work Station Shelving	39
WH-COS-1836	--	Work Station Shelving	39
WH-COS-1848	--	Work Station Shelving	39
WH-COS-1860	--	Work Station Shelving	39
WH-COS-1872	--	Work Station Shelving	39
WH-COS-1884	--	Work Station Shelving	39
WH-COS-1896	--	Work Station Shelving	39
WH-CRATE	--	WinFab Sink & Table Modification	12, 12 & 37
WH-CT12XXXX	--	WinFab Sink & Table Modification	12 & 22
WH-CT14XXXX	--	WinFab Sink & Table Modification	12 & 22
WH-CT16XXXX	--	WinFab Sink & Table Modification	12 & 22
WH-CTMOD	--	WinFab Sink & Table Modification	12 & 22
WH-DBCTN	--	WinFab Sink & Table Modification	12 & 22
WH-DCSB	--	WinFab Sink & Table Modification	12 & 22
WH-DCSB14	--	WinFab Sink & Table Modification	12 & 22
WH-DEO	--	WinFab Table Modification	37
WH-DISPENSE	--	WinFab Table Modification	37
WH-DL	--	WinFab Table Modification	37
WH-DMFH	--	WinFab Sink Modification	12
WH-DUP	--	WinFab Table Modification	37
WH-DUPLEX	--	WinFab Table Modification	37
WH-DUPLEXGFI	--	WinFab Table Modification	37
WH-DUPLEXUND	--	WinFab Table Modification	37
WH-DW	--	WinFab Table Modification	37
WH-ECRSPL	--	WinFab Table Modification	37
WH-ESP	--	WinFab Table Modification	37
WH-EXDB	--	WinFab Sink & Table Modification	12 & 22
WH-EXPCRATE	--	WinFab Sink & Table Modification	12, 22 & 37
WH-FAUCLOC	--	Dish Table Modification	22
WHGR-65-H-TN	524912	Garment Rack	117
WH-GROMMET	--	WinFab Table Modification	37
WH-HFLEG	--	WinFab Sink & Table Modification	12 & 22
WH-HG24DR	--	WinFab Table Modification	37
WH-HGDR	--	WinFab Table Modification	37

Model Number	Order#	Product Description	Page#
WH-HO	--	WinFab Table Modification	37
WH-HUB	--	WinFab Table Modification	37
WH-INTPART	--	WinFab Table Modification	37
WH-LAND	--	Dish Table Modification	22
WH-LVSB	--	WinFab Sink & Table Modification	12 & 22
WH-LWB	--	WinFab Sink & Table Modification	12 & 22
WH-MARCT	--	WinFab Table Modification	37
WH-MIRROR	--	WinFab Table Modification	37
WH-MITER	--	WinFab Table Modification	37
WH-NBS	--	Dish Table Modification	22
WH-NOTTOPT	--	WinFab Table Modification	37
WH-OMIT2-FAUCET	--	WinFab Table Modification	37
WH-OMIT-FAUCET	--	WinFab Table Modification	37
WH-OVFLCT	--	WinFab Sink Modification	12
WH-OVS10	--	WinFab Table Modification	37
WH-OVS12	--	WinFab Table Modification	37
WH-OVS15	--	WinFab Table Modification	37
WH-OVS18	--	WinFab Table Modification	37
WHP-1030	104117	Sani-platter	126
WHP-1224	104125	Sani-platter	126
WHP-1230	104141	Sani-platter	126
WHP-1826GABS	111819	Storage Tray, Green	126
WHP-1826WABS	111835	Storage Tray, White	126
WHP-1826WH	111843	Display Storage Tray	126
WH-PASST	--	WinFab Sink & Table Modification	22 & 37
WH-PCO	--	WinFab Table Modification	37
WH-PFB-101410/KIT	--	WinFab Table Modification	37
WH-PFB-141612/KIT	--	WinFab Table Modification	37
WH-PFB-162012/KIT	--	WinFab Table Modification	37
WH-PFB-16208/KIT	--	WinFab Table Modification	37
WH-PFB-181812/KIT	--	WinFab Table Modification	37
WH-PFB-182412/KIT	--	WinFab Table Modification	37
WH-PFB-202012/KIT	--	WinFab Table Modification	37
WH-PFB-20208/KIT	--	WinFab Table Modification	37
WH-PFB2-101410/KIT	--	WinFab Table Modification	37
WH-PFB2-141612/KIT	--	WinFab Table Modification	37
WH-PFB2-162012/KIT	--	WinFab Table Modification	37
WH-PFB2-16208/KIT	--	WinFab Table Modification	37
WH-PFB2-181812/KIT	--	WinFab Table Modification	37
WH-PFB2-182412/KIT	--	WinFab Table Modification	37
WH-PFB2-202012/KIT	--	WinFab Table Modification	37
WH-PFB2-20208/KIT	--	WinFab Table Modification	37
WH-PFB2-242412/KIT	--	WinFab Table Modification	37
WH-PFB2-242412/KIT	--	WinFab Table Modification	37
WHPL-8BL-RC	643233	Lug, Blue	129
WHPL-8GY	104432	Lug, Gray	129
WHPL-8LID-GY	138608	Lug Lid, Gray	129
WHPL-8LID-WH	128979	Lug Lid, White	129
WHPL-8RD-RD	643225	Lug, Red	129
WHPL-8WH	104459	Lug, White	129
WH-PLH	--	WinFab Table Modification	37
WH-PRDO	--	WinFab Table Modification	37
WH-PRSG	--	WinFab Table Modification	37
WH-PRSG-108-CM	--	Table Pot Rack Center Mt	39
WH-PRSG-108-RM	--	Table Pot Rack Rear Mt	39
WH-PRSG-108-SM	--	Table Pot Rack Splash Mt	39
WH-PRSG-120-CM	--	Table Pot Rack Center Mt	39
WH-PRSG-120-RM	--	Table Pot Rack Rear Mt	39
WH-PRSG-120-SM	--	Table Pot Rack Splash Mt	39
WH-PRSG-132-CM	--	Table Pot Rack Center Mt	39

Model Number	Order#	Product Description	Page#
WH-PRSG-132-RM	--	Table Pot Rack Rear Mt	39
WH-PRSG-132-SM	--	Table Pot Rack Splash Mt	39
WH-PRSG-144-CM	--	Table Pot Rack Center Mt	39
WH-PRSG-144-RM	--	Table Pot Rack Rear Mt	39
WH-PRSG-144-SM	--	Table Pot Rack Splash Mt	39
WH-PRSG-36-CM	--	Table Pot Rack Center Mt	39
WH-PRSG-36-RM	--	Table Pot Rack Rear Mt	39
WH-PRSG-36-SM	--	Table Pot Rack Splash Mt	39
WH-PRSG-48-CM	--	Table Pot Rack Center Mt	39
WH-PRSG-48-RM	--	Table Pot Rack Rear Mt	39
WH-PRSG-48-SM	--	Table Pot Rack Splash Mt	39
WH-PRSG-60-CM	--	Table Pot Rack Center Mt	39
WH-PRSG-60-RM	--	Table Pot Rack Rear Mt	39
WH-PRSG-60-SM	--	Table Pot Rack Splash Mt	39
WH-PRSG-72-CM	--	Table Pot Rack Center Mt	39
WH-PRSG-72-RM	--	Table Pot Rack Rear Mt	39
WH-PRSG-72-SM	--	Table Pot Rack Splash Mt	39
WH-PRSG-84-CM	--	Table Pot Rack Center Mt	39
WH-PRSG-84-RM	--	Table Pot Rack Rear Mt	39
WH-PRSG-84-SM	--	Table Pot Rack Splash Mt	39
WH-PRSG-96-CM	--	Table Pot Rack Center Mt	39
WH-PRSG-96-RM	--	Table Pot Rack Rear Mt	39
WH-PRSG-96-SM	--	Table Pot Rack Splash Mt	39
WHPP6122.5D	683665	Drip Pan for Heater Proofer	143
WHPS1110	583189	Hand Sink	14
WHPS1616	157681	Hand Sink	14
WH-RBP	--	WinFab Table Modification	37
WH-RE	--	WinFab Table Modification	37
WH-REINF	--	WinFab Table Modification	37
WH-REMKP	--	WinFab Table Modification	37
WH-RLSBL	--	Dish Table Modification	22
WH-RMFAP	--	WinFab Table Modification	37
WH-RSB	--	WinFab Sink & Table Modification	12 & 22
WH-RTCO	943551	WinFab Table Modification	37
WHSC-3	112934	Film Wrappers - Console Model	100
WH-SCBL	--	WinFab Sink & Table Modification	12 & 22
WH-SDDEAD	--	WinFab Table Modification	37
WH-SLIDDR	--	WinFab Table Modification	37
WH-SP24	--	WinFab Table Modification	37
WH-SP30	--	WinFab Table Modification	37
WH-SPCU	--	WinFab Sink & Table Modification	12, 22 & 37
WH-SPFH	--	WinFab Sink Modification	12
WHSP-2128S	126017	Heavy Duty, Galvanized, Sheet Pan Truck	75
WHSS-1	112985	Film Wrappers - Table Model	100
WHSS-A	113056	Film Axle	142
WHSS-BBS	113072	Bearing Block	142
WHSSBX-1015/2H	625625	Stainless Display Trays	128
WHSSBX-1030/1H	625609	Stainless Display Trays	128
WHSSBX-1030/1H/4DH	631700	Stainless Display Trays w drain holes	128
WHSSBX-615/2H	625561	Stainless Display Trays	128
WHSSBX-615/2H/4DH	631662	Stainless Display Trays w drain holes	128
WHSSBX-630/1H	625545	Stainless Display Trays	128
WHSSBX-630/1H/4DH	631646	Stainless Display Trays w drain holes	128
WHSSBX-630/2H	625553	Stainless Display Trays	128
WHSSBX-630/2H/4DH	631654	Stainless Display Trays w drain holes	128

Model Number	Order#	Product Description	Page#
WHSSBX-815/2H	625596	Stainless Display Trays	128
WHSSBX-815/2H/4DH	631697	Stainless Display Trays w drain holes	128
WHSSBX-830/1H	625570	Stainless Display Trays	128
WHSSBX-830/1H/4DH	631671	Stainless Display Trays w drain holes	128
WHSSBX-830/2H/4DH	631689	Stainless Display Trays w drain holes	128
WHSSBX-Rack-2655-SS	636295	Stainless Steel Drying Rack	128
WHSS-CAP	113081	Core Adapter/Pin Unit	142
WHSS-CAW	113099	Core Adapter, Wing Unit	142
WHSS-CBD-A	695885	Circuit Board	142
WHSS-COR-A	687025	Cut-Off Rod	142
WHSS-E	113128	Heating Element Only	142
WHSS-EWC	113136	Electric Wire	142
WHSS-FHD	113144	Fuse Holder	142
WHSS-FUS1	113152	Fuse	142
WHSS-HP6	113161	Hot Plate With Heating Element	142
WH-SSI	--	WinFab Sink & Table Modification	12, 22 & 37
WH-SSIBB	--	WinFab Table Modification	37
WH-SSKRT	--	WinFab Sink Modification	12
WH-SSP	--	WinFab Sink & Table Modification	12, 22 & 37
WHSS-PR	135087	Plate Retainers	142
WHSS-RS	113224	Lighted Rocker Switch	142
WHSS-TC6	113232	Teflon Cover	142
WHSS-TK	113259	Thermostat Knob	142
WHSS-TM	113267	Thermostat	142
WH-STEPCDOWN	--	WinFab Table Modification	37
WH-TC0036	--	WinFab Table Modification	37
WH-TC0U36	--	WinFab Table Modification	37
WH-TRASHCH	--	WinFab Table Modification	37
WH-UR-108	--	Work Station Utensil Rack	39
WH-UR-120	--	Work Station Utensil Rack	39
WH-UR-132	--	Work Station Utensil Rack	39
WH-UR-144	--	Work Station Utensil Rack	39
WH-UR-36	--	Work Station Utensil Rack	39
WH-UR-48	--	Work Station Utensil Rack	39
WH-UR-60	--	Work Station Utensil Rack	39
WH-UR-72	--	Work Station Utensil Rack	39
WH-UR-84	--	Work Station Utensil Rack	39
WH-UR-96	--	Work Station Utensil Rack	39
WH-URN	--	WinFab Table Modification	37
WH-URTCO	--	WinFab Table Modification	37
WH-USDB	974041	WinFab Sink Modification	12
WH-USDB	974041	Dish Table Accessory	22
WH-WATRG	--	WinFab Sink & Table Modification	12 & 22
WH-WELL	--	WinFab Table Modification	37
WH-WFJ	--	WinFab Sink & Table Modification	12, 22 & 37
WH-WHCG	--	WinFab Sink & Table Modification	12 & 37
WHWS1410HV	177068	Hand Sink	14
WJ-USTU	--	WinFab Table Modification	37
WL-16/CB	138253	Garment/16 person locker	136
WL-21	156216	Double tier 1 column locker	134
WL-21/15	163846	Double tier 1 column locker	134
WL-4	156099	Garment wall mount 4 door	134
WL-55	626433	Locker, 5 tier 1 Col	135
WL-6	152864	Double tier 3 column lockers	134
WL-6/15	163942	Double tier 3 column lockers	134

Model Number	Order#	Product Description	Page#
WL-618	130358	Six tier 3 column locker	135
WL-618/15	163854	Six tier 3 column locker	135
WL-618/18	163900	Six tier 3 column locker	135
WL-66	156195	Six tier 1 column locker	135
WL-66/15	163862	Six tier 1 column locker	135
WL-66/18	163918	Six tier 1 column locker	135
WL-BB12	324216	Replacement box base for 12" depth	137
WL-BB15	324224	Replacement box base for 15" depth	137
WL-BB18	324232	Replacement box base for 18" depth	137
WLST-12	162376	Slope top crown kit	137
WLST-15	165681	Slope top crown kit	137
WLST-18	162384	Slope top crown kit	137
WP-1815/PPT	110947	Wire Pan Rack	54
WP-1830D/PT	110998	Wire Pan Rack	54
WP-1836B	111034	Wire Pan Rack	54
WPT-2340	126594	Produce Cart	118
WPT-2340-AL-WM	487947	Produce Cart	118
WS1T1618	157518	SS Sinks 1 Compartment	5
WS1T1618/14DP/14GA	--	SS Sinks 1 Compartment	5
WS1T1618/14DP/2D18/14GA	--	SS Sinks 1 Compartment	5
WS1T1618/14DP/2D24/14GA	--	SS Sinks 1 Compartment	5
WS1T1618/2D18	--	SS Sinks 1 Compartment	5
WS1T1618/2D24	--	SS Sinks 1 Compartment	5
WS1T1618LD18	157526	SS Sinks 1 Compartment	6
WS1T1618LD18/14DP/14GA	--	SS Sinks 1 Compartment	6
WS1T1618LD24	157542	SS Sinks 1 Compartment	6
WS1T1618LD24/14DP/14GA	--	SS Sinks 1 Compartment	6
WS1T1618RD18	157534	SS Sinks 1 Compartment	6
WS1T1618RD18/14DP/14GA	--	SS Sinks 1 Compartment	6
WS1T1618RD24	157551	SS Sinks 1 Compartment	6
WS1T1618RD24/14DP/14GA	--	SS Sinks 1 Compartment	6
WS1T1620	265480	SS Sinks 1 Compartment	5
WS1T1620/14DP/14GA	673678	SS Sinks 1 Compartment	5
WS1T1620/14DP/2D18/14GA	673993	SS Sinks 1 Compartment	5
WS1T1620/14DP/2D24/14GA	674005	SS Sinks 1 Compartment	5
WS1T1620/2D18	673002	SS Sinks 1 Compartment	5
WS1T1620/2D24	673011	SS Sinks 1 Compartment	5
WS1T1620LD18	666814	SS Sinks 1 Compartment	6
WS1T1620LD18/14DP/14GA	673766	SS Sinks 1 Compartment	6
WS1T1620LD24	388906	SS Sinks 1 Compartment	6
WS1T1620LD24/14DP/14GA	673782	SS Sinks 1 Compartment	6
WS1T1620RD18	672886	SS Sinks 1 Compartment	6
WS1T1620RD18/14DP/14GA	673774	SS Sinks 1 Compartment	6
WS1T1620RD24	672894	SS Sinks 1 Compartment	6
WS1T1620RD24/14DP/14GA	673791	SS Sinks 1 Compartment	6
WS1T1818	438424	SS Sinks 1 Compartment	5
WS1T1818/14DP/14GA	673660	SS Sinks 1 Compartment	5
WS1T1818/14DP/2D18/14GA	673977	SS Sinks 1 Compartment	5
WS1T1818/14DP/2D24/14GA	673985	SS Sinks 1 Compartment	5
WS1T1818/2D18	266511	SS Sinks 1 Compartment	5
WS1T1818/2D24	672982	SS Sinks 1 Compartment	5
WS1T1818LD18	237876	SS Sinks 1 Compartment	6
WS1T1818LD18/14DP/14GA	673723	SS Sinks 1 Compartment	6
WS1T1818LD24	568042	SS Sinks 1 Compartment	6
WS1T1818LD24/14DP/14GA	673740	SS Sinks 1 Compartment	6
WS1T1818RD18	417156	SS Sinks 1 Compartment	6
WS1T1818RD18/14DP/14GA	673731	SS Sinks 1 Compartment	6
WS1T1818RD24	581301	SS Sinks 1 Compartment	6
WS1T1818RD24/14DP/14GA	673758	SS Sinks 1 Compartment	6
WS1T1824	157606	SS Sinks 1 Compartment	5

Model Number	Order#	Product Description	Page#
WS1T1824/14DP/14GA	673694	SS Sinks 1 Compartment	5
WS1T1824/14DP/2D18/14GA	674030	SS Sinks 1 Compartment	5
WS1T1824/14DP/2D24/14GA	674048	SS Sinks 1 Compartment	5
WS1T1824/2D18	274327	SS Sinks 1 Compartment	5
WS1T1824/2D24	631515	SS Sinks 1 Compartment	5
WS1T1824LD18	157614	SS Sinks 1 Compartment	6
WS1T1824LD18/14DP/14GA	673854	SS Sinks 1 Compartment	6
WS1T1824LD24	157631	SS Sinks 1 Compartment	6
WS1T1824LD24/14DP/14GA	673871	SS Sinks 1 Compartment	6
WS1T1824RD18	157622	SS Sinks 1 Compartment	6
WS1T1824RD18/14DP/14GA	673862	SS Sinks 1 Compartment	6
WS1T1824RD24	157649	SS Sinks 1 Compartment	6
WS1T1824RD24/14DP/14GA	673889	SS Sinks 1 Compartment	6
WS1T2020	672827	SS Sinks 1 Compartment	5
WS1T2020/14DP/14GA	673686	SS Sinks 1 Compartment	5
WS1T2020/14DP/2D18/14GA	674013	SS Sinks 1 Compartment	5
WS1T2020/14DP/2D24/14GA	674021	SS Sinks 1 Compartment	5
WS1T2020/2D18	673037	SS Sinks 1 Compartment	5
WS1T2020/2D24	673045	SS Sinks 1 Compartment	5
WS1T2020LD18	672907	SS Sinks 1 Compartment	6
WS1T2020LD18/14DP/14GA	673811	SS Sinks 1 Compartment	6
WS1T2020LD24	672923	SS Sinks 1 Compartment	6
WS1T2020LD24/14DP/14GA	673838	SS Sinks 1 Compartment	6
WS1T2020RD18	672915	SS Sinks 1 Compartment	6
WS1T2020RD18/14DP/14GA	673820	SS Sinks 1 Compartment	6
WS1T2020RD24	672931	SS Sinks 1 Compartment	6
WS1T2020RD24/14DP/14GA	673846	SS Sinks 1 Compartment	6
WS1T2028	672835	SS Sinks 1 Compartment	5
WS1T2028/14DP/14GA	673715	SS Sinks 1 Compartment	5
WS1T2028/14DP/2D18/14GA	674064	SS Sinks 1 Compartment	5
WS1T2028/14DP/2D24/14GA	674072	SS Sinks 1 Compartment	5
WS1T2028/2D18	673053	SS Sinks 1 Compartment	5
WS1T2028/2D24	673061	SS Sinks 1 Compartment	5
WS1T2028LD18	672940	SS Sinks 1 Compartment	6
WS1T2028LD18/14DP/14GA	673918	SS Sinks 1 Compartment	6
WS1T2028LD24	672966	SS Sinks 1 Compartment	6
WS1T2028LD24/14DP/14GA	673934	SS Sinks 1 Compartment	6
WS1T2028RD18	672958	SS Sinks 1 Compartment	6
WS1T2028RD18/14DP/14GA	673926	SS Sinks 1 Compartment	6
WS1T2028RD24	672974	SS Sinks 1 Compartment	6
WS1T2028RD24/14DP/14GA	673942	SS Sinks 1 Compartment	6
WS1T2424	157657	SS Sinks 1 Compartment	5
WS1T2424/14DP/14GA	673707	SS Sinks 1 Compartment	5
WS1T2424/14DP/2D18/14GA	674056	SS Sinks 1 Compartment	5
WS1T2424/14DP/2D24/14GA	444859	SS Sinks 1 Compartment	5
WS1T2424/2D18	209365	SS Sinks 1 Compartment	5
WS1T2424/2D24	571575	SS Sinks 1 Compartment	5
WS1TS2424LD24	157665	SS Sinks 1 Compartment	6
WS1TS2424LD24/14DP/14GA	673897	SS Sinks 1 Compartment	6
WS1TS2424RD24	157673	SS Sinks 1 Compartment	6
WS1TS2424RD24/14DP/14GA	673900	SS Sinks 1 Compartment	6
WS1T-SS2020-8/MLC	484201	Silver Soak Sink	11
WS2T1618	--	SS Sinks 2 Compartment	7
WS2T1618/14DP/14GA	--	SS Sinks 2 Compartment	7
WS2T1618/14DP/14GA/2D18	--	SS Sinks 2 Compartment	7
WS2T1618/14DP/14GA/2D24	--	SS Sinks 2 Compartment	7
WS2T1618/2D18	--	SS Sinks 2 Compartment	7
WS2T1618/2D24	--	SS Sinks 2 Compartment	7
WS2T1618LD18	--	SS Sinks 2 Compartment	8
WS2T1618LD18/14DP/14GA	--	SS Sinks 2 Compartment	8
WS2T1618LD24	--	SS Sinks 2 Compartment	8
WS2T1618LD24/14DP/14GA	--	SS Sinks 2 Compartment	8

Model Number	Order#	Product Description	Page#
WS2T1618RD18	567971	SS Sinks 2 Compartment	8
WS2T1618RD18/14DP/14GA	--	SS Sinks 2 Compartment	8
WS2T1618RD24	--	SS Sinks 2 Compartment	8
WS2T1618RD24/14DP/14GA	--	SS Sinks 2 Compartment	8
WS2T1620	673070	SS Sinks 2 Compartment	7
WS2T1620/14DP/14GA	674099	SS Sinks 2 Compartment	7
WS2T1620/14DP/14GA/2D18	674380	SS Sinks 2 Compartment	7
WS2T1620/14DP/14GA/2D24	674398	SS Sinks 2 Compartment	7
WS2T1620/2D18	673256	SS Sinks 2 Compartment	7
WS2T1620/2D24	673264	SS Sinks 2 Compartment	7
WS2T1620LD18	673133	SS Sinks 2 Compartment	8
WS2T1620LD18/14DP/14GA	674187	SS Sinks 2 Compartment	8
WS2T1620LD24	430001	SS Sinks 2 Compartment	8
WS2T1620LD24/14DP/14GA	674208	SS Sinks 2 Compartment	8
WS2T1620RD18	673141	SS Sinks 2 Compartment	8
WS2T1620RD18/14DP/14GA	674195	SS Sinks 2 Compartment	8
WS2T1620RD24	673150	SS Sinks 2 Compartment	8
WS2T1620RD24/14DP/14GA	674216	SS Sinks 2 Compartment	8
WS2T1818	157331	SS Sinks 2 Compartment	7
WS2T1818/14DP/14GA	674081	SS Sinks 2 Compartment	7
WS2T1818/14DP/14GA/2D18	674363	SS Sinks 2 Compartment	7
WS2T1818/14DP/14GA/2D24	674371	SS Sinks 2 Compartment	7
WS2T1818/2D18	157340	SS Sinks 2 Compartment	7
WS2T1818/2D24	157358	SS Sinks 2 Compartment	7
WS2T1818LD18	157438	SS Sinks 2 Compartment	8
WS2T1818LD18/14DP/14GA	674144	SS Sinks 2 Compartment	8
WS2T1818LD24	157411	SS Sinks 2 Compartment	8
WS2T1818LD24/14DP/14GA	674161	SS Sinks 2 Compartment	8
WS2T1818RD18	157446	SS Sinks 2 Compartment	8
WS2T1818RD18/14DP/14GA	674152	SS Sinks 2 Compartment	8
WS2T1818RD24	157420	SS Sinks 2 Compartment	8
WS2T1818RD24/14DP/14GA	674179	SS Sinks 2 Compartment	8
WS2T1824	157366	SS Sinks 2 Compartment	7
WS2T1824/14DP/14GA	674110	SS Sinks 2 Compartment	7
WS2T1824/14DP/14GA/2D18	674427	SS Sinks 2 Compartment	7
WS2T1824/14DP/14GA/2D24	674435	SS Sinks 2 Compartment	7
WS2T1824/2D18	157374	SS Sinks 2 Compartment	7
WS2T1824/2D24	157382	SS Sinks 2 Compartment	7
WS2T1824LD18	157454	SS Sinks 2 Compartment	8
WS2T1824LD18/14DP/14GA	674267	SS Sinks 2 Compartment	8
WS2T1824LD24	157471	SS Sinks 2 Compartment	8
WS2T1824LD24/14DP/14GA	674283	SS Sinks 2 Compartment	8
WS2T1824RD18	157462	SS Sinks 2 Compartment	8
WS2T1824RD18/14DP/14GA	674275	SS Sinks 2 Compartment	8
WS2T1824RD24	157489	SS Sinks 2 Compartment	8
WS2T1824RD24/14DP/14GA	674291	SS Sinks 2 Compartment	8
WS2T2020	673088	SS Sinks 2 Compartment	7
WS2T2020/14DP/14GA	674101	SS Sinks 2 Compartment	7
WS2T2020/14DP/14GA/2D18	674401	SS Sinks 2 Compartment	7
WS2T2020/14DP/14GA/2D24	674419	SS Sinks 2 Compartment	7
WS2T2020/2D18	499340	SS Sinks 2 Compartment	7
WS2T2020/2D24	532269	SS Sinks 2 Compartment	7
WS2T2020LD18	673168	SS Sinks 2 Compartment	8
WS2T2020LD18/14DP/14GA	674224	SS Sinks 2 Compartment	8
WS2T2020LD24	673184	SS Sinks 2 Compartment	8
WS2T2020LD24/14DP/14GA	674241	SS Sinks 2 Compartment	8
WS2T2020RD18	673176	SS Sinks 2 Compartment	8
WS2T2020RD18/14DP/14GA	674232	SS Sinks 2 Compartment	8
WS2T2020RD24	673192	SS Sinks 2 Compartment	8
WS2T2020RD24/14DP/14GA	674259	SS Sinks 2 Compartment	8
WS2T2028	673096	SS Sinks 2 Compartment	7
WS2T2028/14DP/14GA	674136	SS Sinks 2 Compartment	7

Model Number	Order#	Product Description	Page#
WS2T2028/14DP/14GA/2D18	674460	SS Sinks 2 Compartment	7
WS2T2028/14DP/14GA/2D24	674478	SS Sinks 2 Compartment	7
WS2T2028/2D18	673272	SS Sinks 2 Compartment	7
WS2T2028/2D24	673281	SS Sinks 2 Compartment	7
WS2T2028LD18	673213	SS Sinks 2 Compartment	8
WS2T2028LD18/14DP/14GA	674321	SS Sinks 2 Compartment	8
WS2T2028LD24	673230	SS Sinks 2 Compartment	8
WS2T2028LD24/14DP/14GA	674347	SS Sinks 2 Compartment	8
WS2T2028RD18	673221	SS Sinks 2 Compartment	8
WS2T2028RD18/14DP/14GA	674339	SS Sinks 2 Compartment	8
WS2T2028RD24	673248	SS Sinks 2 Compartment	8
WS2T2028RD24/14DP/14GA	674355	SS Sinks 2 Compartment	8
WS2T2424	157391	SS Sinks 2 Compartment	7
WS2T2424/14DP/14GA	674128	SS Sinks 2 Compartment	7
WS2T2424/14DP/14GA/2D18	674443	SS Sinks 2 Compartment	7
WS2T2424/14DP/14GA/2D24	674451	SS Sinks 2 Compartment	7
WS2T2424/2D18	643541	SS Sinks 2 Compartment	7
WS2T2424/2D24	157403	SS Sinks 2 Compartment	7
WS2T-DIS-ME-1410-10DP	675391	Drop in Sink	15
WS2T-DIS-ME-1614-10DP	675403	Drop in Sink	15
WS2T-DIS-ME-1614-12DP	675411	Drop in Sink	15
WS2T-DIS-ME-1620-10DP	675438	Drop in Sink	15
WS2T-DIS-ME-1620-12DP	675446	Drop in Sink	15
WS2T-DIS-ME-1620-8DP	675420	Drop in Sink	15
WS2TS2424LD24	157497	SS Sinks 2 Compartment	8
WS2TS2424LD24/14DP/14GA	674304	SS Sinks 2 Compartment	8
WS2TS2424RD24	157500	SS Sinks 2 Compartment	8
WS2TS2424RD24/14DP/14GA	674312	SS Sinks 2 Compartment	8
WS3T10142D12	591525	SS Convenience Sink	11
WS3T10142D18	595809	SS Convenience Sink	11
WS3T14162D12	521797	SS Convenience Sink	11
WS3T15322D18	159652	Stainless Meat Platter Sink	11
WS3T1532LD18	159636	Stainless Meat Platter Sink	11
WS3T1532RD18	159644	Stainless Meat Platter Sink	11
WS3T1618	157155	SS Sinks 3 Compartment	9
WS3T1618/14DP/14GA	--	SS Sinks 3 Compartment	9
WS3T1618/14DP/14GA/2D18	--	SS Sinks 3 Compartment	9
WS3T1618/14DP/14GA/2D24	--	SS Sinks 3 Compartment	9
WS3T1618/2D18	--	SS Sinks 3 Compartment	9
WS3T1618/2D24	--	SS Sinks 3 Compartment	9
WS3T1618LD18	157235	SS Sinks 3 Compartment	10
WS3T1618LD18/14DP/14GA	--	SS Sinks 3 Compartment	10
WS3T1618LD24	157251	SS Sinks 3 Compartment	10
WS3T1618LD24/14DP/14GA	--	SS Sinks 3 Compartment	10
WS3T1618RD18	157243	SS Sinks 3 Compartment	10
WS3T1618RD18/14DP/14GA	--	SS Sinks 3 Compartment	10
WS3T1618RD24	157260	SS Sinks 3 Compartment	10
WS3T1618RD24/14DP/14GA	--	SS Sinks 3 Compartment	10
WS3T1620	673328	SS Sinks 3 Compartment	9
WS3T1620/14DP/14GA	674494	SS Sinks 3 Compartment	9
WS3T1620/14DP/14GA/2D18	674793	SS Sinks 3 Compartment	9
WS3T1620/14DP/14GA/2D24	674822	SS Sinks 3 Compartment	9
WS3T1620/2D18	378492	SS Sinks 3 Compartment	9
WS3T1620/2D24	673651	SS Sinks 3 Compartment	9
WS3T1620LD18	673387	SS Sinks 3 Compartment	10
WS3T1620LD18/14DP/14GA	674591	SS Sinks 3 Compartment	10
WS3T1620LD24	388851	SS Sinks 3 Compartment	10
WS3T1620LD24/14DP/14GA	674611	SS Sinks 3 Compartment	10
WS3T1620RD18	673395	SS Sinks 3 Compartment	10
WS3T1620RD18/14DP/14GA	674603	SS Sinks 3 Compartment	10
WS3T1620RD24	673408	SS Sinks 3 Compartment	10
WS3T1620RD24/14DP/14GA	674620	SS Sinks 3 Compartment	10

Model Number	Order#	Product Description	Page#
WS3T1818	673310	SS Sinks 3 Compartment	9
WS3T1818/14DP/14GA	674486	SS Sinks 3 Compartment	9
WS3T1818/14DP/14GA/2D18	674777	SS Sinks 3 Compartment	9
WS3T1818/14DP/14GA/2D24	674785	SS Sinks 3 Compartment	9
WS3T1818/2D18	439689	SS Sinks 3 Compartment	9
WS3T1818/2D24	673643	SS Sinks 3 Compartment	9
WS3T1818LD18	644851	SS Sinks 3 Compartment	10
WS3T1818LD18/14DP/14GA	674558	SS Sinks 3 Compartment	10
WS3T1818LD24	673352	SS Sinks 3 Compartment	10
WS3T1818LD24/14DP/14GA	674574	SS Sinks 3 Compartment	10
WS3T1818RD18	644877	SS Sinks 3 Compartment	10
WS3T1818RD18/14DP/14GA	674566	SS Sinks 3 Compartment	10
WS3T1818RD24	673361	SS Sinks 3 Compartment	10
WS3T1818RD24/14DP/14GA	674582	SS Sinks 3 Compartment	10
WS3T1824	157180	SS Sinks 3 Compartment	9
WS3T1824/14DP/14GA	674515	SS Sinks 3 Compartment	9
WS3T1824/14DP/14GA/2D18	674857	SS Sinks 3 Compartment	9
WS3T1824/14DP/14GA/2D24	674865	SS Sinks 3 Compartment	9
WS3T1824/2D18	157198	SS Sinks 3 Compartment	9
WS3T1824/2D24	157201	SS Sinks 3 Compartment	9
WS3T1824LD18	157278	SS Sinks 3 Compartment	10
WS3T1824LD18/14DP/14GA	674671	SS Sinks 3 Compartment	10
WS3T1824LD24	157294	SS Sinks 3 Compartment	10
WS3T1824LD24/14DP/14GA	674697	SS Sinks 3 Compartment	10
WS3T1824RD18	157286	SS Sinks 3 Compartment	10
WS3T1824RD18/14DP/14GA	674689	SS Sinks 3 Compartment	10
WS3T1824RD24	157307	SS Sinks 3 Compartment	10
WS3T1824RD24/14DP/14GA	674700	SS Sinks 3 Compartment	10
WS3T1928	--	Stainless Bakery Sink	11
WS3T19282D18	170368	Stainless Bakery Sink	11
WS3T1928LD18	--	Stainless Bakery Sink	11
WS3T1928RD18	--	Stainless Bakery Sink	11
WS3T2020	394003	SS Sinks 3 Compartment	9
WS3T2020/14DP/14GA	674507	SS Sinks 3 Compartment	9
WS3T2020/14DP/14GA/2D18	674831	SS Sinks 3 Compartment	9
WS3T2020/14DP/14GA/2D24	674849	SS Sinks 3 Compartment	9
WS3T2020/2D18	401120	SS Sinks 3 Compartment	9
WS3T2020/2D24	430262	SS Sinks 3 Compartment	9
WS3T2020LD18	673416	SS Sinks 3 Compartment	10
WS3T2020LD18/14DP/14GA	674638	SS Sinks 3 Compartment	10
WS3T2020LD24	673432	SS Sinks 3 Compartment	10
WS3T2020LD24/14DP/14GA	674654	SS Sinks 3 Compartment	10
WS3T2020RD18	673424	SS Sinks 3 Compartment	10
WS3T2020RD18/14DP/14GA	674646	SS Sinks 3 Compartment	10
WS3T2020RD24	673441	SS Sinks 3 Compartment	10
WS3T2020RD24/14DP/14GA	674662	SS Sinks 3 Compartment	10
WS3T2028	673336	SS Sinks 3 Compartment	9
WS3T2028/14DP/14GA	674531	SS Sinks 3 Compartment	9
WS3T2028/14DP/14GA/2D18	674890	SS Sinks 3 Compartment	9
WS3T2028/14DP/14GA/2D24	674902	SS Sinks 3 Compartment	9
WS3T2028/2D18	400477	SS Sinks 3 Compartment	9
WS3T2028/2D24	271038	SS Sinks 3 Compartment	9
WS3T2028LD18	673459	SS Sinks 3 Compartment	10
WS3T2028LD18/14DP/14GA	674734	SS Sinks 3 Compartment	10
WS3T2028LD24	673475	SS Sinks 3 Compartment	10
WS3T2028LD24/14DP/14GA	674751	SS Sinks 3 Compartment	10
WS3T2028RD18	673467	SS Sinks 3 Compartment	10
WS3T2028RD18/14DP/14GA	674742	SS Sinks 3 Compartment	10
WS3T2028RD24	216670	SS Sinks 3 Compartment	10
WS3T2028RD24/14DP/14GA	674769	SS Sinks 3 Compartment	10
WS3T2424	157219	SS Sinks 3 Compartment	9
WS3T2424/14DP/14GA	674523	SS Sinks 3 Compartment	9



Model Number	Order#	Product Description	Page#
WS3T2424/14DP/14GA/2D18	674873	SS Sinks 3 Compartment	9
WS3T2424/14DP/14GA/2D24	674881	SS Sinks 3 Compartment	9
WS3T2424/2D18	395591	SS Sinks 3 Compartment	9
WS3T2424/2D24	157227	SS Sinks 3 Compartment	9
WS3T-DIS-ME-1410	646434	Drop in Sink	15
WS3T-DIS-ME-1416	675374	Drop in Sink	15
WS3T-DIS-ME-2016	675382	Drop in Sink	15
WS3TS2424LD24	157315	SS Sinks 3 Compartment	10
WS3TS2424LD24/14DP/14GA	674718	SS Sinks 3 Compartment	10
WS3TS2424RD24	157323	SS Sinks 3 Compartment	10
WS3TS2424RD24/14DP/14GA	674726	SS Sinks 3 Compartment	10
WSA-PSC1532	--	WinFab Sink Modification	12
WSA-PSC1618	--	WinFab Sink Modification	12
WSA-PSC1620	--	WinFab Sink Modification	12
WSA-PSC1818	--	WinFab Sink Modification	12
WSA-PSC1824	--	WinFab Sink Modification	12
WSA-PSC1928	--	WinFab Sink Modification	12
WSA-PSC2020	--	WinFab Sink Modification	12
WSA-PSC2028	--	WinFab Sink Modification	12
WSA-PSC2424	--	WinFab Sink Modification	12
WSA-SSC1014	--	WinFab Sink Modification	12
WSA-SSC1416	--	WinFab Sink Modification	12
WSA-SSC1532	--	WinFab Sink Modification	12
WSA-SSC1618	--	WinFab Sink Modification	12
WSA-SSC1620	--	WinFab Sink Modification	12
WSA-SSC1818	--	WinFab Sink Modification	12
WSA-SSC1824	--	WinFab Sink Modification	12
WSA-SSC1928	--	WinFab Sink Modification	12
WSA-SSC2020	--	WinFab Sink Modification	12
WSA-SSC2020	--	Dish Table Accessory	22
WSA-SSC2028	--	WinFab Sink Modification	12
WSA-SSC2424	--	WinFab Sink Modification	12
WSBB1118	207714	Bagel, bread and bun basket, Slant Top	127
WS-BD-15ST	173403	Faucet or Part	25
WS-BD-35ST	159741	Faucet or Part	25
WS-CWS-K271000	--	Faucet or Part	25
WS-DIS-FE-1014/6DP	675024	Drop in Sink	15
WS-DIS-FE-1110/10DP	674953	Drop in Sink	15
WS-DIS-FE-1110/6DP	588086	Drop in Sink	15
WS-DIS-FE-1410/10DP	675016	Drop in Sink	15
WS-DIS-FE-1410/6DP	674911	Drop in Sink	15
WS-DIS-FE-1416/8DP	674961	Drop in Sink	15
WS-DIS-FE-1620/12DP	675008	Drop in Sink	15
WS-DIS-FE-1620/8DP	674996	Drop in Sink	15
WS-DIS-FE-2028/12DP	674988	Drop in Sink	15
WS-DIS-FE-99/3DP	674970	Drop in Sink	15
WS-DIS-ME-1010DP8	634564	Drop in Sink	15
WS-DIS-ME-109.5DP10	630715	Drop in Sink	15
WS-DIS-ME-1109	522511	Drop in Sink	15
WS-DIS-ME-1114	520698	Drop in Sink	15
WS-DIS-ME-1621-12DP	--	Drop in Sink	15
WS-DIS-ME-1621DP14	654371	Drop in Sink	15
WS-FP-K2520000	567381	Faucet or Part	25
WS-FP-ST	173411	Faucet or Part	25
WS-GFF	--	Faucet or Part	25
WS-GF-RKIT	--	Faucet or Part	25
WS-GSEM-6SP	382934	Faucet or Part	24
WS-GSNECK	382934	Faucet or Part	24
WS-GS-ST	173438	Faucet or Part	24
WSHS-1410-5-/2SP	--	Hand Sink	14
WSHS-1410-5-F	627364	Hand Sink	14

Model Number	Order#	Product Description	Page#
WSHS-1410-EF	480876	Hand Sink	14
WS-KV-ST	567496	Faucet or Part	25
WS-OA-E501000	--	Faucet or Part	25
WS-PT-E307740	--	Faucet or Part	25
WS-RLWV-ST	159708	Faucet or Part	25
WS-RWG	--	Faucet or Part	25
WS-SDDEAD	--	WinFab Sink Modification	12
WS-SDDEAD	--	Dish Table Modification	22
WS-SD-ST	173446	Faucet or Part	25
WS-SF-12ST-LF	--	Faucet or Part	24
WS-SF-14ST	159783	Faucet or Part	24
WS-SF-14ST-LF	--	Faucet or Part	24
WS-SF-18SU	243707	Faucet or Part	24
WS-SF-8ST-LF	--	Faucet or Part	24
WS-SFSV-65ST	589409	Faucet or Part	25
WS-SFSM-14ST	159687	Faucet or Part	24
WS-SFSM-14ST-LF	--	Faucet or Part	24
WS-SFSM-14SU	159695	Faucet or Part	24
WS-SFSM-18SU	243707	Faucet or Part	24
WS-SGF-12ST	250616	Faucet or Part	24
WS-SPR-ST	159661	Faucet or Part	24
WS-SPR-ST-LF	--	Faucet or Part	24
WS-SPR-SU	159679	Faucet or Part	24
WS-TMV-ST	--	Faucet or Part	25
WS-WSS	--	Faucet or Part	25
WTO-016	416444	WinFab Table Modification	38
WTO-017	416461	WinFab Table Modification	38
WTO-018	416418	WinFab Table Modification	38
WTO-019	416410	WinFab Table Modification	38
WTS3648	162413	SS Table with Wood Top	29
WTS3660	162421	SS Table with Wood Top	29
WTS3672	113902	SS Table with Wood Top	29
WTS3696	113911	SS Table with Wood Top	29
WTSS3648	162456	SS Table with Wood Top	29
WTSS3660	114067	SS Table with Wood Top	29
WTSS3672	162464	SS Table with Wood Top	29
WTSS3696	162472	SS Table with Wood Top	29
WWHS1410SP	172638	Hand Sink	14
WX-1000KA/AB-WM	524971	Stocking and Marking Cart	116
XB	Option	AL Racks Option HD Vertical Upright	49
XB	Option	SS Rack Option HD Vertical Upright	57
XT-BLC	101776	Tube For Bulk Movers, 3 Bushel	95
4471	169826	WinFab Sink & Table Accessory	12 & 22
4994	132505	Extra Pot Hooks	44
7111	122171	3" Rubber Wheel	145
7465	123502	Rigid Plate Caster 6" Polyurethane Wheel	145
/ADJ	Option	Correctional Shelving Adjustable feet option	90
/HSP	Option	Hasp for Receiving Desk	138
/MLC	Option	Correctional Shelving Locking Casters option	90
110	126543	Stocking and Marking Cart	115
148BIN-BL	182713	Ingredient Bin, Blue	73
148BIN-WH	130008	Ingredient Bin, White	73
148BIN-YW	129980	Ingredient Bin, Yellow	73
148COV	111931	Ingredient Bin Cover, Clear	73
148COV-AL	693011	Ingredient Bin Cover, Aluminum	73
148PIB	111940	Triple Ingredient Bin	73



Model Number	Order#	Product Description	Page#
2FL	Option	Option Mop Sink right & left flashings	15
2SP	Option	Right & Left Sidesplash for Hand Sink	14
300-48D	100079	U Boat	109
300-48D/PU	100095	U Boat	109
300-60D	100271	U Boat	109
300-60D/PU	100343	U Boat	109
300-60D/SDR	268373	U-Boat with Slanted Shelves	112
300-60D-HCH	609035	CardBoard Catcher	108
300-60D-ULTRA	596166	Ultra U-Boat	108
303SPPCW	895529	Swivel Plate Caster 3-1/4" Polyurethane Wheel	145
30-6-A/BL	161111	Bulk Movers Aluminum Base 6 Bushel	95
30-6-A/GY	153066	Bulk Movers 6 Bushel AL	95
30-6-A/RD	161103	Bulk Movers 6 Bushel AL	95
30-6-A/WH	101477	Bulk Movers 6 Bushel AL	95
30-6-SS/BL	679623	Bulk Movers 6 Bushel SS	95
30-6-SS/GY	--	Bulk Movers 6 Bushel SS	95
30-6-SS/RD	515442	Bulk Movers 6 Bushel SS	95
30-6-SS/WH	638186	Bulk Movers 6 Bushel SS	95
30-8-AL/BL	155942	Bulk Movers 8 Bushel AL	95
30-8-AL/RD	161138	Bulk Movers 8 Bushel AL	95
30-8-AL/WH	161120	Bulk Movers 8 Bushel AL	95
308MR	100853	Magnesium Hand Truck	120
308SP	100861	Magnesium Hand Truck	120
30-8-SS/BL	--	Bulk Movers 8 Bushel SS	95
30-8-SS/RD	237753	Bulk Movers 8 Bushel SS	95
30-8-SS/WH	631321	Bulk Movers 8 Bushel SS	95
311-033	218544	SS Clips for Poly Tops	132
4497-3	285261	WinFab Sink Modification	12
4497-3	285261	Dish Table Accessory	22
4497-3	285261	WinFab Table Modification	37
4793	154448	Race Fitting for GR-60	111
4FM0359P	899634	Replacement Poly Liner for IB-S216W/P16NF	72
500CH	185025	Stocking and Marking Cart	118
508SP	133680	Twin handle pipe hand truck 10" semi-pneumatic	120
550	100722	Utility Cart	114
550HD	100757	Utility Cart	114
550HD/SX	100765	Utility Cart	114
711	122155	Mold-on rubber wheels	145
7112	122180	Polyurethane wheels	145
71121	122198	Polyurethane wheels	145
7113	122235	Mold-on rubber wheels	145
7114	122243	Phenolic wheels	145
7115	122260	Mold-on Polyurethane wheels	145
7116	122294	Mold-on Polyurethane wheels	145
71181	122323	Phenolic wheels	146
7119	122331	Phenolic wheels	145

Model Number	Order#	Product Description	Page#
712	128750	Mold-on rubber wheels	145
7120	122358	Poly wheels	145
7125	122403	Polyurethane wheels	145
7128	122438	Polyurethane wheels	145
7129	122446	Polyurethane wheels	145
7130	122462	Polyurethane wheels	145
714	128768	Semi-Pneumatic wheels	146
715	122665	Hand truck wheels	146
716	122673	Solid rubber wheels	145
717	122681	Poly wheels	145
718	122690	Poly wheels	145
73111	122972	Swivel plate caster w/6" poly wheel	145
73111BK	291389	Swivel plate caster w/6" poly wheel & brake	145
7313	122999	Swivel plate casters	145
73161	123035	Swivel plate casters	145
7317	123043	Swivel plate casters	145
7318	123051	Swivel Plate Caster w/5" Polyurethane Wheel	145
732	123078	Swivel plate casters	145
7321CBZ	123086	Swivel plate casters	145
7322	123094	Swivel plate casters	146
7324CBZ	246641	Heavy Duty Swivel Plate Caster	145
7351	123211	Swivel plate casters	145
738	123246	Swivel plate casters	145
738A	128784	Swivel plate casters	145
739	123271	Swivel plate casters	145
7411	123300	Rigid plate casters	145
7412	123318	Rigid plate caster	145
7418	123369	Rigid plate casters	145
745CBZ	258239	5" Mold-on Rubber Wheel	145
746	123481	Rigid swivel plate caster	145
7462	123490	Rigid plate casters	145
7471	123537	Rigid plate casters	145
749	123561	Rigid plate casters	145
750	240565	Swivel Stem Wheel Caster	146
751	123588	Swivel stem casters	146
753	123625	Swivel stem casters	146
7537	214990	Rigid stem casters	146
7548	123650	Swivel stem casters	146
756	123676	Swivel stem casters	146
757	123684	Swivel stem casters	146
9000-STK4	137533	Stocking and Marking Cart with Chrome Finish	118
99MR	100870	Twin handle tubular hand truck 8" mold-on rubber	120
99MR/PO	624956	Push Off Hand Truck	120
99SP	100888	Twin handle tubular hand truck 10"semi-pneumatic	120



WINFAB FABRICATION

RACKS

HEATER PROOFERS
& CABINETS

TRANSPORT &
MOBILE STORAGE

SHELVING

FOOD HANDLING
SUPERMARKET

MERCHANDISING

MATERIAL HANDLING

ROLL CAGES &
DISTRIBUTION CARTS

SMALLWARES

LOCKERS &
RECEIVING DESKS

WHEELS & PARTS

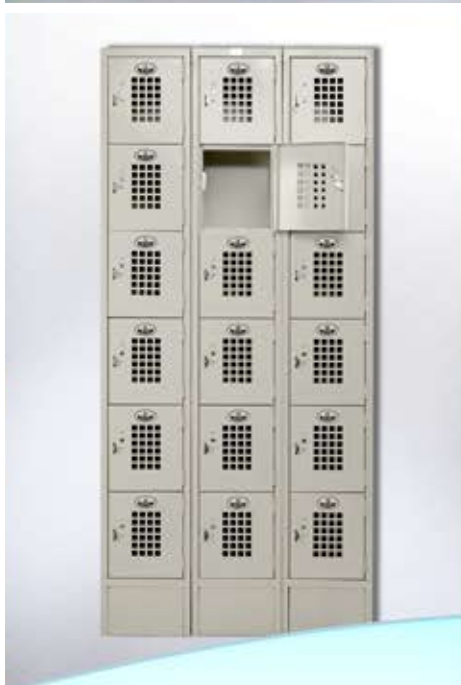

Winholt Equipment Group
20 Crossways Park North, Suite 205
Woodbury NY 11797



Founded in 1946

Toll Free: 800.444.3595
Ph: 516.222.0335 | Fax: 516.921.0538
www.winholt.com

New York | Pennsylvania | Texas | California | China

Use with Catalog Volume 4.14