



arc
cardinal

creator of experiences.



2025/2026 PORTFOLIO

From the first sip of a drink to the last bite of dessert, Arc Cardinal takes pride in offering products for every stage of the dining experience. From glassware, dinnerware, flatware, and buffetware, we are dedicated to delivering exceptional quality to help you craft unforgettable moments for your guests. This holistic approach is beautifully reflected in the cover spread of our catalog—an artistic showcase of our tableware collections with imaginative tablescapes and culinary creations.

The cover features Corn Cake with Carrot Mustard and Vanilla Pickled Carrots, plated by Chef Dennis MacDonald on Eternity Plus by Chef & Sommelier®, and a Blood Orange Mezcal with a Thyme Garnish, served in the Cabernet Coupe Cocktail by Chef & Sommelier®.

Molly Cagwin, New York
Cover image

Chef Dennis MacDonald, Maritimes, Canada
Cover image



arc
cardinal

creator of experiences.

TRUSTED & TRUE

As part of Arc International, founded in 1825, we will always stay true to our roots of quality, durability, and value. We will always be your first and most trusted source for tableware and buffetware.

VISIT OUR CORPORATE SHOWROOMS:

TOTOWA, NJ | NEW YORK, NY

Discover a partner showroom in your area by visiting
[ArcCardinal.com/Showrooms](https://www.arccardinal.com/showrooms)

ARCCARDINAL.COM





Creators of Experience

CREATE. CURATE. CELEBRATE.

Elevating your guest's experience is your priority. Bringing your vision to life is ours. No matter the experience, we are here to help you create a remarkable one. Our expertly crafted collections of tableware, buffetware, and accessories supports the needs of today's chefs, mixologists and sommeliers.

This visionary approach is the founding principle of our culture and brands.



The Ritz-Carlton, Grand Cayman

CAYMAN ISLANDS

"At The Ritz-Carlton Grand Cayman, we are always looking for innovative, trendy, and quality build vessels to showcase our luxury food products. This is what we found using the Domino White Podium system from Abert, out of the Arc Cardinal Catalog. The mix of metal and decorated tiles goes very well with our buffet set up and brings color and style to our food presentation!"

FREDERIC MORINEAU // CULINARY DIRECTOR

SHOP THESE COLLECTIONS:

Terra Collection - Page 234

Domino Wood Collection - Page 314



317 Main Street

FARMINGDALE, NY

"At 317 Main Street and Vico Restaurant, our passion revolves around pizza and pasta—the ultimate comfort foods. The bold design of Candour Azure provides the perfect backdrop for our pasta dishes, elevating both the presentation and our guests' dining experience. When it came time to bring my recipes to life in my cookbook, Arc Cardinal was my top choice for dinnerware. Their diverse collection beautifully complemented the wide range of dishes featured in the book, making each one shine."

ERIC LEVINE // OWNER & CHEF

SHOP THESE COLLECTIONS:
Candour Azure Collection - Page 212
Rondo Collection - Page 206



@walescommunications

Bosscat Kitchen and Libations

HOUSTON, TX & OLD TOWNE ORANGE, CA

"At Bosscat Kitchen and Libations, updating our menus seasonally across all four locations is a priority. The Harvest collection by Dudson from Arc Cardinal provides us with the perfect canvas for our creative seasonal dishes. With its vibrant colors, diverse shapes, and exceptional durability, the collection seamlessly enhances our evolving menus, making the transition effortless and stylish."

**LESLIE NGUYEN // CO-FOUNDER,
DAILY DOSE HOSPITALITY**





2941 Restaurant

FALLS CHURCH, VA

"When 2941 was nominated as the most Outstanding Restaurant in the United States by the James Beard Foundation, it reaffirmed our commitment to excellence in every detail—including our choice of dinnerware. Dudson's dinnerware is the perfect canvas for our culinary creations, combining versatility, design, and texture. Its understated elegance enhances each dish, letting the ingredients shine while complementing our artistry. I'm thrilled to showcase our food on pieces that reflect the same dedication to quality we bring to our kitchen every day."

BERTRAND CHEMEL // CHEF



Viaggio Ristorante

WAYNE, NJ

"When choosing plateware for my restaurants—Viaggio Ristorante, Osteria Crescendo, and my newest concept, Bar Mutz—I wanted pieces that were versatile and elevated the presentation of every dish. Dudson dinnerware stood out with its stylish, minimalist design that perfectly complements our menu. At Viaggio and Osteria Crescendo, we blend simple Italian traditions with a modern touch, so having classic, adaptable pieces that showcase seasonal dishes was essential. For Bar Mutz, a unique Italian trattoria-meets-mozzarella bar concept with innovative cocktails and mozzarella-inspired dishes, I selected a few of Arc Cardinal's dinnerware and drinkware collections. Their sleek, sophisticated designs provide the ideal backdrop for our menu. Collaborating with Arc Cardinal has been an awesome experience!"

ROBBIE FELICE // CHEF & PARTNER

SHOP THESE COLLECTIONS:

Evo Collection - Page 228

Organic White Collection - Page 178



Grandio

MONTREAL, QC

"We greatly appreciate the exceptional quality of Arc Cardinal products. The Dudson line has added a touch of refinement to our restaurant, Moishes, while the Chef & Sommelier glassware has elevated the dining experience at our steakhouse, Gibby's. Their craftsmanship and elegance perfectly complement our commitment to excellence."

GUILLAUME BRIERE // VICE-PRÉSIDENT EXÉCUTIF

SHOP THESE COLLECTIONS:

Sequence Collection - Page 48

Brixton Collection - Page 118

Organic White Collection - Page 178



High Ridge Palm Beach

PALM BEACH, FL

"At High Ridge Palm Beach, every detail plays a role in creating an exceptional experience for our members. Our dedication to excellence extends to our tableware, which is why we proudly use Harvest Ink dinnerware, Knox flatware, and sleek cocktail glasses like Zephyr and Sequence from Arc Cardinal.

These collections bring a refined elegance to our presentation, enhancing every dish and cocktail we serve. The response from our guests has been outstanding, and our culinary team is delighted with how these products elevate the dining experience."

MICHEL PERSONNAZ // EXECUTIVE CHEF

SHOP THESE COLLECTIONS:

Zephyr Collection - Page 32

Sequence Collection - Page 48

Harvest Collection - Page 182

Knox Collection - Page 270



Hilton Nashville Airport

NASHVILLE, TN

"I love using Arc Cardinal's Candour collection, especially the pasta bowl, which invites guests to enjoy their meal while seamlessly fitting the diverse cuisines we serve. After extensive culinary training in Lyon, France, my cooking blends Indonesian, Parisian, Italian, and American influences. Candour's wide rims and beautiful color perfectly complement each dish. The plateware enhances both presentation and versatility across our hotel's menu."

TATY AGUSTINA // CHEF



Gibsons

CHICAGO, IL

"At Gibsons, we take pride in being a Chicago icon, renowned for our exceptional steaks. Our menu features a thoughtfully curated wine list, perfectly complementing every cut of meat to enhance the dining experience. We chose Arc Cardinal glassware because it combines timeless elegance with a modern edge, offering classic shapes like martini glasses and universal wine glasses. This choice elevates the presentation of our cocktails, beers, and wines while maintaining the durability needed to handle our high-volume service. Serving hundreds of glasses of wine each night, it was crucial for us to select glassware that could withstand the demands of our operation while adding a touch of sophistication to our customers' dining experience."

DOMENICO MUZZUPAPPA // PURCHASING MANAGER



Shands General

PATCHOGUE, LONG ISLAND, NY

"Selecting the perfect glassware was essential for creating the sleek, sophisticated, and trendy ambiance of The State Room, our cocktail lounge and tasting room. With a beverage menu featuring meticulously crafted cocktails and an extensive wine selection, we were impressed by the offerings from Arc Cardinal's Chef & Sommelier and Arcoroc collections. The wine glasses we chose are versatile enough for both our wine program and cocktail presentations, while the stemmed cocktail glasses are ideal for showcasing spirit-forward drinks. Arc Cardinal has been a reliable partner, consistently delivering stunning glassware that elevates our service and delights our guests."

BERT WIEGAND // PARTNER, BEVERAGE DIRECTOR

SHOP THESE COLLECTIONS:

Cabernet Wine - Page 54

Cocktail Glasses - Page 138



The Brown Palace

DENVER, CO

"Finding the right dinnerware collection was essential for us—not just for enhancing presentation but also for providing versatility across our menu. The Arc Cardinal Dudson Harvest Collection has truly exceeded our expectations.

The mix-and-match color options allow us to create visually striking presentations, whether for appetizers or entrées. Beyond its aesthetic appeal, the durability of the Harvest Collection ensures it stands up to the demands of our busy service without compromising its charm. We couldn't be more pleased with this collection!"

ADRIAN CARSON // EXECUTIVE CHEF

SHOP THESE COLLECTIONS:
Villeneuve Collection - Page 42
Harvest Collection - Page 182



Cork Fire Kitchen

TEMECULA WINE VALLEY, CA

"The diversity in style, shape and aesthetics are among the reasons why I chose to use Arc Cardinal as our primary source for plateware here at Cork Fire Kitchen and Temecula Creek Inn. I love the color contrast of the Harvest line and Candour Azure they really elevate the look of the food; and the Geode line has to be my top favorite it has tones of classic plateware but with a modern twist."

BEN DIAZ // CHEF

SHOP THESE COLLECTIONS:

Candour Azure Collection - Page 212

Geode Collection - Page 226



South & Pine

MORRISTOWN, NJ

"At South & Pine, we take pride in our commitment to locally sourcing ingredients and a thoughtfully curated seasonal menu. When it comes to tableware that enhances our vision, Arc Cardinal has been an ideal partner. Their Geode and Organic White collection strikes the perfect balance between modern elegance and rustic charm, while the Chef & Sommelier flatware impresses with its durability and timeless beauty. I'm always excited to see what innovative designs Arc Cardinal will bring to the table."

LEIA GACCIONE // OWNER & CHEF

SHOP THESE COLLECTIONS:

Geode Collection - Page 226

Organic White Collection - Page 178



Valued Partners



We are proud to support and partner with The USA & Canada delegation of the Association of Maîtres Cuisiniers de France (MCF). MCF accepts only the best French Chefs in the world. Being a Maître Cuisinier (or Master Chef of France) is a prestigious honor that is held in high regard. These chefs are given the highest classification in restaurant guides and are regularly mentioned in top food and travel publications. MCF's motto is, "To preserve and spread the French culinary arts, encourage training in cuisine, and assist in professional development."

We are very pleased to be partnering with such an illustrious organization!



Valued Partners



We are proud to partner with the USA & Canada delegation of the Académie Culinaire de France. Established in 1883, the ACF is the world's oldest association for chefs and pastry chefs, committed to promoting culinary excellence and advancing the science of the culinary arts. Welcoming chefs from across the globe, the American and Canadian delegation includes 200 esteemed members from diverse sectors, such as hotels, restaurants, pastry shops, chocolate shops, research and development labs, and production facilities.

Among them are exceptional professionals including executive chefs, pastry chefs, master chocolatiers, scientists, winemakers, restaurateurs, and nutritionists. This collaboration reflects our shared dedication to craftsmanship, quality, and innovation. It is an honor to be partnered with the Académie Culinaire de France.



Valued Partners



We are proud to partner with the foodservice division of Aussie Beef & Lamb in North America. Dedicated to educating chefs and foodservice operators about quality meat and sustainable farming within the global protein supply chain, Aussie Beef & Lamb sets the standard for excellence.

As their trusted plateware partner, we collaborate closely at events and with their network of chefs to deliver innovative, stylish products that perfectly complement their premium Australian proteins.

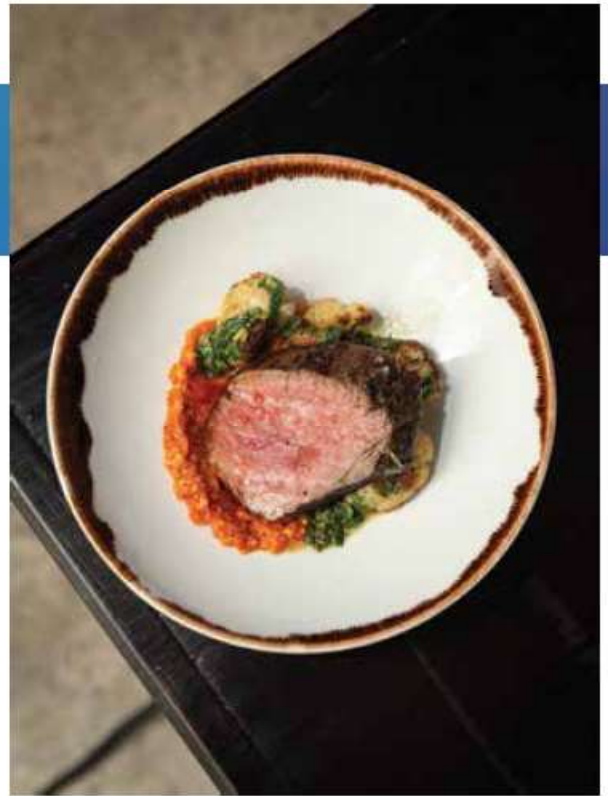



Waterfall Collection (Page 294)



Broadway Color (Page 114)



Valentina Collection (Page 240)

Preview of New Products



Grace Collection (Page 30)



Harvest Mediterranean Moresque (Page 186)



Starline Collection (Page 90)



Art & Table (Page 366)



Exaltation Collection (Page 46)



Matisse Gold Collection (Page 279)

! MORE NEW PRODUCTS INSIDE!



GLASSWARE, DINNERWARE, FLATWARE

SERVING YOUR TALENT

Chef & Sommelier® is a foodservice brand created in collaboration with master chefs and sommeliers. Each collection combines elegance, creativity and superior material performance, enhancing fine dishes and wines like no other. Chef & Sommelier® embodies the “French art of living” through the expertise of design and the resistance of innovative materials.

GLASSWARE, DINNERWARE, FLATWARE

ARCOROC

EVERYDAY APPROVED

Arcoroc® offers an extensive range of dinnerware, glassware and flatware products. Durable, functional and stylish, Arcoroc® provides strong, practical products designed for intensive daily use.



DINNERWARE

OVER 200 YEARS OF HERITAGE

Renowned craft potters, the prestigious Dudson brand carries a rich heritage dating back to 1800. With inspirational products recognized by chefs worldwide for their industrial toughness and authentic design.



DINNERWARE

A CANVAS FOR CHEFS. INSPIRE. CREATE. PLATE.

A mix of matte stoneware with metal & wood accessories creates a unique experience for a variety of cuisines. Santa Anita is a ceramic leader in Mexico. With over 30 years of experience, Santa Anita has been a leading brand of high-quality stoneware products.



DINNERWARE

Maria Portugal Terracota pieces are inspired by ancient processes and traditions from the history of ceramics and the visual richness found in Portugal, but also the adventure of new challenges and trends. The decoration is all handmade, which allows for a unique and distinctive handcrafted touch in all the pieces.



FLATWARE

CREATOR AND MANUFACTURER OF THE FINEST CUTLERY SINCE 1866.

For over 150 years, this Swiss cutlery manufacturer offers high quality 18/10 flatware combined with trendy designs.



FLATWARE, BUFFETWARE, ACCESSORIES

SINCE 1929, ABERT HAS DISTINGUISHED ITSELF WITH ITS ABILITY TO INTERPRET THE MARKET AS WELL AS THEIR SUSTAINABLE PRACTICES.

Abert offers top quality Italian craftsmanship and innovation. The high quality of materials and functional designs will support the daily use of professionals.



BUFFETWARE

PROUDLY HANDCRAFTED IN THE FRENCH ARDENNES.

Chasseur is a partner brand for Arc Cardinal. Rooted in the heart of the food and wine region of France, Chasseurs' cast iron cookware and serveware is manufactured to the highest quality standards and favored by top chefs from around the world.



BUFFETWARE

As the leading manufacturer of convenient insulated products for over 116 years, Thermos® brand is trusted by foodservice professionals to provide innovative beverage servers that are high-performing and durable. All backed with NSF Certification.



BUFFETWARE

alfi® premium insulated carafes have set standards for the industry with its strict quality standards and award winning designs since 1914.

Table of Contents



Drinkware

AERIS

Grace NEW	30
Zephyr NEW	32

KRYSTA

Cabernet	54
Distinction NEW	52
Evidence NEW	62
Exalt	60
Exaltation NEW	46
Open Up	36
Reveal Up	38
Sequence	48
Sublym	44
Symétrie NEW	40
Villeneuve	42
Aska	64
Lima	65
Macaron	66
Primary	67
Architecte	68
Macassar	68
Rendez-Vous	69

ARMORIM + SHEER RIM

Malea Brio	80
Mineral	72
Romeo	76
Serena NEW	74
V. Juliette	78
Precision	81

FULLY TEMPERED GLASS

Amelia	88
Artic	89
Excalibur	84
Arcadie	100
Essentials	104
Gotham	103
Granite	102
Mugs	95
Norvege	94
Prysm	94
Rock Line NEW	92
Rock Dew NEW	93
Stack Up	98
Stack Up Cross NEW	96
Starline NEW	90

ARMORIM

Urbane	108
--------	-----

EVERYDAY CLASSICS

Aristocrat	125
Brixton NEW	118
Broadway	114
Cabernet	123
Cooler	126
Imperator, Elysees, Quadrille NEW	119
Islande	120
Luxe NEW	116
Mason Jar	124
Monti NEW	112
Perfection	124
Salto	117
Shetland	122
Wine Bottom Tumblers	127
ArcoPrime	128

OCCASION

Sparkling Wine	132
Spirits	138
Beer	152
In-Room Tumblers	161
Decanters & Carafes	162
Mix	166
Outdoor Perfect	170



Dinnerware

FULLY GLAZED FOOT

Eternity Plus	194
EVO Origins	180
Harvest	182
Harvest Mediterranean Moresque NEW	186
Harvest Norse White NEW	188
Organic White	178
The Maker's Collection: FINCA LIMESTONE	190
The Maker's Collection: PORTO BLUE NEW	192

BONE CHINA

Infinity	200
Infinity Coupes	202

ALUMINITE®

Athena NEW	210
Candour	218
Candour Azure	212
Candour Cirrus	214
Candour Coupes	216
Horizon	208
Rondo	206
Universal NEW	222
Vintage	220

VITRIFIED STONEWARE

EVO Azure NEW	232
EVO	228
Geode	226
Terra NEW	234
Reflections NEW	236
Reflections Blue Band NEW	238
Valentina NEW	240

Accessories	242
Acacia Wood	231

EXTRA STRONG PORCELAIN

Appetizer	247
Daring	247
Square Up	246

OPAL®

Brush Blue Jean	250
Evolutions	256
Intensity White	254
Restaurant White	252

FULLY TEMPERED GLASS

Arcade	260
Fleur	260
ROC	260
Stack Bowls	260

NON-TEMPERED GLASS

Dessert	261
---------	-----

Table of Contents



Flatware

MODERN

Black Oak	271
Black Oak Satin NEW	272
Blake NEW	275
Diaz	269
Ezzo	269
Greenwich	275
Kya	268
Kya Sand	268
Knox	270
Lazzo	272
Living Satin	270
Living Mirror	271
Neo NEW	273
Stilo NEW	273

CLASSIC

Burlington	280
Elegant NEW	281
Latham	279
Latham Sand	280
Matisse NEW	278
Matisse Vintage NEW	278
Matisse Vintage Gold NEW	279
Matiz	283
Milord NEW	281
Satineo	283
Vesca	282

UPDATED TRADITIONAL

Baguette Black	286
Baguette Vintage Stone Wash	286
Capitale	291
Enrico VIII NEW	290
Harrison	291
Fluted	287
Orzon	287
Orzon Patina	288
Rada NEW	289
Renzo	288
Renzo Patina	289
Victory NEW	290

TRANSITIONAL

Alessandria	295
Amber	301
Harper	297
Harper Satin	298
Imperial Chopsticks	302
Liv	295
Liv II NEW	296
Liv Gunmetal NEW	296
Luxus Sand	298
Mikayla	301
Miracle	294
Monaco Satin NEW	297
Rinascimento NEW	299
Splendido NEW	299
Stone	300
Stone Satin	300
Waterfall NEW	294

STEAK KNIVES

Chef & Sommelier®	304
Abert NEW	305
Arcoroc®	305

SERVING ACCESORIES

Lazzo	306
Living Mirror	307
Vesca	307



Buffetware

ABERT

Domino	312
Mix & Play	318
Cosmo	320
Accessories	324
Serving	325

ALFI

Albergo	328
Gusto Top Therm	330
Hotello	332
Lightweight Carafe	334

THERMOS

Brew In Carafe	338
Carafe With Gauge	340
Carafe With Lever	342
Twist and Pour	344
Accessories	346

CHASSEUR

Round & Oval Casserole	350
Round & Oval Casserole	352
Terrine Rectangle Gratin	354
Round & Oval Dish	356
Trivets NEW	357



Accessories

ABERT **NEW**

Tempo Lamps	362
Tempo Mini Lamps	364
Saturno Lamps	365
Art & Table	366
Serving	367
Wine & Bar	368

ARCOROC

Ashtrays & Votive	369
-------------------	-----

Reference

Custom Decoration	370
Care & Handling	372
Index	381



Drinkware





Aeris

— HANDMADE —

Aeris – Mouth-blown crystalline glassware. Each piece embodies a lightweight design that seamlessly combines refinement and luxurious craftsmanship. Add a touch of sophistication to every moment.

Grace <i>NEW</i>	30
Zephyr <i>NEW</i>	32



Mouth Blown – Creating ultra thin walls, these pieces are mouth blown.



Sheer Rim – Fine rims add for a refined customer experience.



Grace **NEW**

The Grace collection blends modern aesthetics with timeless elegance, enhancing the dining ambiance with its sophisticated design and mouth-blown craftsmanship.



FP633
Flute (8 Oz.)
H: 9 1/2" T: 1 9/16"
B: 2 3/4" M: 2 5/8"
2 Dz.



FP678
Universal Wine (14 Oz.)
H: 8 3/4" T: 2 1/2"
B: 3" M: 3 1/8"
2 Dz.



FP631
Universal Wine (18 Oz.)
H: 9" T: 2 1/2"
B: 3 1/8" M: 3 1/2"
2 Dz.



FP632
Universal Wine (23 1/2 Oz.)
H: 9 1/4" T: 2 5/8"
B: 3 3/8" M: 3 7/8"
2 Dz.

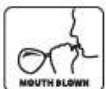



Zephyr **NEW**

Infusing timeless artistry with contemporary elegance, the Zephyr collection is designed to enthrall and charm. Each piece is delicately crafted with both precision and exquisite artistry.



FP303
Specialty Cocktail (7 ½ Oz.)
H: 6 ½" T: 4 ½"
B: 3 ½" M: 4 ¾"
2 Dz.



FP373
Rocks (10 ½ Oz.)
H: 2 ¾" T: 3 ¼"
B: 3 ¼" M: 3 ¼"
2 Dz.



FP374
Double Rocks (13 Oz.)
H: 3 ¾" T: 3 ¾"
B: 3 ¾" M: 3 ¾"
2 Dz.



FP375
Hi Ball (12 Oz.)
H: 5" T: 2 ½"
B: 2 ½" M: 2 ½"
2 Dz.

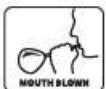





High-performance crystal glass. A new generation of lead-free crystal exceeding 2,000 industrial dishwashing cycles. Superior strength, complete transparency, long-lasting brilliance and perfect acoustics.

Open Up	36
Reveal Up	38
Symétrie NEW	40
Villeneuve	42
Sublym	44
Exaltation NEW	46
Sequence	48
Distinction NEW	52
Cabernet	54
Exalt	60
Evidence NEW	62
Aska	64
Lima	65
Macaron	66
Primary	67
Cristal D'Arques	
Architecte	68
Macassar	68
Rendez-Vous	69



Sheer Rim – Fine rims add for a refined customer experience.



Effervescence Plus – A technology that develops even, delicate bubbliness, delighting the eyes and taste buds alike.





Open Up

With its iconic shape, Open Up can be found on the most contemporary of tables. Yet its design reveals a highly technical approach to enhancing young wines. The large oxygenation area and closed rim facilitates the concentration of flavors.

THE ICONIC SHAPE

The shape of the Open Up glass creates an actual "carafe effect" because the wine is oxygenated faster.

The convex part (1) builds the aromas, which are then concentrated in the concave portion of the glass (2).

After a few moments in the glass, the wine's acid content is smoothed out and the tannins are softened, making it possible to fully enjoy even the youngest wines.





4 Oz.

U1051*
Flute (6 ¾ Oz.)
H: 9" T: 2 ¾"
B: 2 13/16" M: 2 ¾"
2 Dz.
4 Oz. pour line



3 ¼ Oz.

U1010
Round (12 ½ Oz.)
H: 8 ¼" T: 2 11/16"
B: 3" M: 3 ¾"
2 Dz.
3 ¼ Oz. pour line



2 Oz.

U1011
Universal Tasting (13 ½ Oz.)
H: 9" T: 2 ¾"
B: 3" M: 3 ½"
2 Dz.
2 Oz. pour line



3 Oz.

U1012
Soft (15 ¾ Oz.)
H: 8 7/8" T: 2 7/16"
B: 3 ¼" M: 4"
2 Dz.
3 Oz. pour line



3 ½ Oz.

U1013
Tannic (18 ½ Oz.)
H: 9 1/8" T: 2 ¾"
B: 3 ¼" M: 4 1/8"
2 Dz.
3 ½ Oz. pour line



U1032
Open Up Warm Tumbler (10 Oz.)
H: 3 ¾" T: 2 ¾"
B: 1 7/8" M: 3 7/8"
2 Dz.



U1033
Open Up Old Fashioned (13 ½ Oz.)
H: 3 ¾" T: 2 ¾"
B: 1 7/8" M: 3 7/8"
2 Dz.





Reveal Up

Choose your tasting experience with Reveal Up. The two shapes in the collection (Soft & Intense) with a natural gauge 2-4 Oz. magnify all wines (sparkling, young or mature).

SOFT | Large oxygenation surface and smaller opening of the bowl for perfect tasting of young or mature, red and white soft wines.



2 ¼ Oz.

J8908*
Soft Wine (11 Oz.)
H: 8 ½" T: 2"
B: 3" M: 3 ¼"
2 Dz.



3 ¼ Oz.

J8743*
Soft Wine (13 ½ Oz.)
H: 9 ½" T: 2 ¼"
B: 3 ¼" M: 3 ½"
2 Dz.

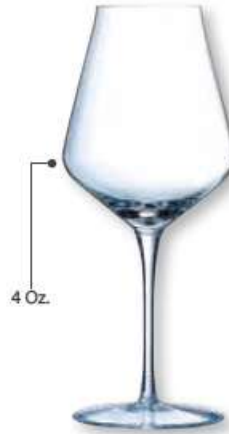

4 Oz.

N1738
Soft Wine (17 ½ Oz.)
H: 9 ¾" T: 2 ¾"
B: 3 ¾" M: 3 ¾"
1 Dz.



J8907*
Soft Flute (8 Oz.)
H: 9 ¼" T: 1 ¾"
B: 2 ¾" M: 2 ¾"
2 Dz.

INTENSE | Extra-large oxygenation surface for perfect tasting of red, young or mature, strong and tannic wines.



3 ¼ Oz.

J8742
Intense Wine (16 Oz.)
H: 8 ¾" T: 2 ¾"
B: 3 ¾" M: 4"
2 Dz.



4 ¼ Oz.

J9014
Intense Wine (19 ½ Oz.)
H: 9" T: 2 ¾"
B: 3 ¾" M: 4 ¼"
2 Dz.



3 STEPS OF WINE TASTING

- LOOK** OXYGENATION SURFACE
> Aromas Source
- SMELL** AROMATIC CHAMBER
> Aromas Development
RIM CLOSING OF THE BOWL
> Aromas Concentration
- TASTE** SHEER RIM (0.9MM)
> Pleasant Touch on Lips
CHIMNEY
> Lower Alcohol Perception



Symétrie ^{NEW}

The soft vertical lines of Symétrie create a stunning back drop for the beverage being served.

An extensive collection offering options in wine, cocktail and sparkling wine/Champagne.





V1483
Wine (13 Oz.)
H: 9 ¼" T: 2 ¼"
B: 3" M: 3 ⅞"
2 Dz.



V0391
Wine (16 ½ Oz.)
H: 9 ⅞" T: 2 ⅜"
B: 3" M: 3 ⅞"
2 Dz.



V2696
Wine (20 ¼ Oz.)
H: 10 ¼" T: 2 ½"
B: 3 ¼" M: 3 ⅞"
1 Dz.



V1171
Coupe (8 Oz.)
H: 7 ⅞" T: 4 ½"
B: 3" M: 4 ½"
2 Dz.



V2697*
Flute (7 ½ Oz.)
H: 9 ½" T: 2 ½"
B: 2 ¾" M: 2 ¼"
2 Dz.



Villeneuve by Daniel Boulud

Meticulously crafted by Daniel Boulud, each glass allows for the true appreciation of the wine, capturing the story of each varietal that is being tasted. This collection seamlessly transitions from fine dining to bistro.



Shown Burgundy (21 ½ Oz.)



FN159
Sweet Wine (9 Oz.)
H: 7 1/4" T: 3"
B: 3 3/8" M: 3 5/16"
1 Dz.



FN166
Universal Wine (16 Oz.)
H: 8 1/4" T: 2 7/16"
B: 3 1/4" M: 3 1/2"
1 Dz.



FN161
Universal Wine (18 Oz.)
H: 9 3/4" T: 2 1/2"
B: 3 1/2" M: 3 1/2"
1 Dz.



FN160
Burgundy (21 1/2 Oz.)
H: 8 1/4" T: 2 1/4"
B: 3 1/2" M: 4 1/8"
1 Dz.



FN162
Bordeaux (24 1/2 Oz.)
H: 10 1/8" T: 2 7/8"
B: 3 1/2" M: 4"
1 Dz.



Q1151*
Exaltation Specialty Flute (10 1/4 Oz.)
H: 8 3/4" T: 2 3/16"
B: 2 7/8" M: 3 1/16"
2 Dz.





Sublym

Elegant & Timeless Design. The Sublym collection brings classic sophistication with a high and narrow bowl design. Designed with no seam, an extra flat foot and an elegant stem. Beautifully complementing Chef & Sommelier® Lima collection tumblers.



L2609
Wine (8 ¾ Oz.)
H: 8 ½" T: 2"
B: 2 ¾" M: 2 ¾"
2 Dz.



L2761
Wine (13 Oz.)
H: 9 ¼" T: 2 ¼"
B: 3" M: 3 ½"
2 Dz.



N1739
Wine (16 ½ Oz.)
H: 9 7/8" T: 2 3/8"
B: 3" M: 3 3/8"
1 Dz.



V3604
Wine (20 ¼ Oz.)
H: 10 ¼" T: 2 ½"
B: 3 ¼" M: 3 3/8"
1 Dz.



L2762*
Flute (7 ½ Oz.)
H: 9 ½" T: 1 ¾"
B: 2 ¾" M: 2 ¼"
2 Dz.



L3678
Coupe Cocktail (8 Oz.)
H: 7 ½" T: 4 ½"
B: 3" M: 4 ½"
2 Dz.



N4742
Ballon (21 ¼ Oz.)
H: 9 5/8" T: 2 3/4"
B: 3 1/4" M: 4 1/8"
1 Dz.



N5368
All Purpose (13 Oz.)
H: 7 ¼" T: 2 ¼"
B: 3" M: 3 ½"
2 Dz.



A wine glass filled with red wine, set against a dark background with warm lighting. The glass is the central focus, with a wide bowl and a slender stem. The wine is a deep red color. The background is dark, with some warm, orange-toned light sources visible on the right side, creating a sophisticated and elegant atmosphere.

Exaltation ^{NEW}

Embrace the Parisian notion of subtle sophistication with the Exaltation wine glasses. The sleek, pulled stem design exudes modern simplicity, while the wide bowl allows the wine's color and aroma to take center stage.



Q1151*
Specialty Flute (10 ¼ Oz.)
H: 8 ¾" T: 2 ¾"
B: 2 ¾" M: 3 ¼"
2 Dz.



V6191
Wine (13 Oz.)
H: 8 ½" T: 3 ¾"
B: 3 ½" M: 3 ¾"
1 Dz.



V6190
Wine (16 Oz.)
H: 9" T: 2 ½"
B: 3 ¾" M: 3 ½"
1 Dz.



V6189
Wine (19 Oz.)
H: 9 ½" T: 2 ½"
B: 3 ¾" M: 3 ¾"
1 Dz.



V6719
Wine (25 ½ Oz.)
H: 10 ¼" T: 2 ¾"
B: 3 ½" M: 4 ¾"
1 Dz.





Sequence

The Glassware Sequence Of The Future. The perfect design progression, bringing a modern update to a classical shape with the essence of crafted crystal.



N9696
Port (7 Oz.)
H: 7 1/2" T: 1 3/4"
B: 2 5/8" M: 2 1/2"
2 Dz.

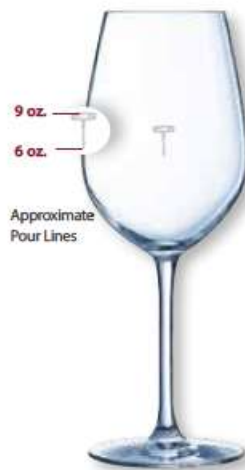

Q1069
Corkscrew Universal (16 Oz.)
H: 9" T: 2 3/8"
B: 3 1/4" M: 3 5/8"
1 Dz.



L5635
 Universal (13 Oz.)
 H: 8 ¼" T: 2 ¼"
 B: 3" M: 3 ⅜"
 1 Dz.



L5633
 Universal (16 Oz.)
 H: 9" T: 2 ⅞"
 B: 3 ¼" M: 3 ⅝"
 1 Dz.



L5638
 Universal (19 ½ Oz.)
 H: 9 ¼" T: 2 ⅝"
 B: 3 ½" M: 3 ⅝"
 1 Dz.



L5636
 Burgundy (20 ½ Oz.)
 H: 8" T: 2 ⅝"
 B: 3 ⅝" M: 3 ⅞"
 1 Dz.



N9710
 Bordeaux (21 Oz.)
 H: 9 ¼" T: 2 ¾"
 B: 3 ½" M: 3 ¾"
 2 Dz.



L5637
 Bordeaux (26 Oz.)
 H: 9 ⅝" T: 2 ⅝"
 B: 3 ⅝" M: 3 ½"
 1 Dz.



Shown Cooler (16 Oz.), Double Old Fashioned (13 ½ Oz.), Coupe Cocktail (7 ¾ Oz.)



L5640*
Flute (6 Oz.)
H: 8 ¼" T: 1 7/8"
B: 2 ¾" M: 2 ¼"
1 Dz.



Q3702
Nick and Nora Cocktail (5 ¼ Oz.)
H: 5 5/8" T: 2 ¾"
B: 2 3/8" M: 2 ¾"
2 Dz.



L5641
Coupe Cocktail (7 ¾ Oz.)
H: 5 7/8" T: 4 3/8"
B: 3" M: 4 3/8"
1 Dz.



Q7785*
Coupe Cocktail (7 Oz.)
H: 6" T: 3 1/16"
B: 2 ¾" M: 3 1/16"
2 Dz.



L5642
All Purpose (14 Oz.)
H: 6 9/16" T: 2 1/2"
B: 3" M: 3 1/8"
1 Dz.



N9711
Iced Tea (16 Oz.)
H: 7 1/4" T: 2 3/4"
B: 3" M: 3 3/8"
2 Dz.



P0089
Belgian Beer (12 1/2 Oz.)
H: 5 7/8" T: 2 1/2"
B: 2 7/8" M: 3 1/4"
2 Dz.



L5757
Rocks (8 1/2 Oz.)
H: 3 1/4" T: 2 3/4"
B: 2 1/8" M: 3 1/8"
1 Dz.



L5758
Rocks (10 1/2 Oz.)
H: 3 3/8" T: 3"
B: 2 1/4" M: 3 3/8"
1 Dz.



L5756
Double Old Fashioned (13 1/2 Oz.)
H: 3 3/8" T: 3"
B: 2 3/8" M: 3 3/8"
1 Dz.



L5754
Hi Ball (11 1/2 Oz.)
H: 5 3/4" T: 2 1/8"
B: 2" M: 2 3/8"
1 Dz.



L5755
Cooler (16 Oz.)
H: 6 3/8" T: 2 1/2"
B: 2 1/2" M: 3"
1 Dz.





Distinction

NEW

The long, seamless stem gives way to a beautifully angled bowl. The natural curvature in the bowl provides proper pour control eliminating waste and increasing profits.



Q9080*
 Flute (7 ¾ Oz.)
 H: 9 ½" T: 1 ¾"
 B: 2 ¾" M: 2 ½"
 2 Dz.



Q9062
 Wine (13 Oz.)
 H: 8 ¾" T: 2 ¼"
 B: 3 ¼" M: 3 ⅝"
 2 Dz.



Q9064
 Wine (16 Oz.)
 H: 9 ½" T: 2 ½"
 B: 3 ⅝" M: 3 ¾"
 2 Dz.



Shown Tall Wine (10 ½ Oz.)



Cabernet

Chef&Sommelier

A wide range of sizes with superior strength;
it's a perfect blend of elegance and endurance.



FJ036
Bordeaux (16 Oz.)
H: 8 ½" T: 2 ¾"
B: 3 ½" M: 3 ¾"
1 Dz.



FJ035
Bordeaux (21 ¼ Oz.)
H: 9 ½" T: 2 ¾"
B: 3 ½" M: 3 ¾"
1 Dz.



FJ037
Burgundy (24 Oz.)
H: 8 ¾" T: 2 ¾"
B: 3 ½" M: 4 ¾"
1 Dz.



46978
Tall Wine (8 ½ Oz.)
H: 7 ½" T: 2 ¼"
B: 2 ¾" M: 2 ¾"
2 Dz.



50816
Tall Wine (10 ½ Oz.)
H: 7 ¾" T: 2 ¾"
B: 3" M: 3 ½"
2 Dz.



46973
Tall Wine (12 Oz.)
H: 8" T: 2 ½"
B: 3" M: 3 ¾"
2 Dz.



46961
Tall Wine (16 Oz.)
H: 8 ¾" T: 2 ¾"
B: 3" M: 3 ½"
2 Dz.



Cabernet *cont'd.*



L0571

Tall Wine with pour line (16 Oz.)

H: 8 3/8" T: 2 3/4" B: 3" M: 3 1/2"

2 Dz.

APPROXIMATE POUR LINES

6 oz. Bottom of Grapes | 9 oz. Top of Grapes



46888

Tall Wine (19 3/4 Oz.)

H: 9 1/8" T: 2 13/16"

B: 3 1/4" M: 3 11/16"

2 Dz.



D0795

Tall Wine (25 1/4 Oz.)

H: 10" T: 3"

B: 3 1/8" M: 3 15/16"

1 Dz.



47019
Ballon Wine (12 Oz.)
H: 7 ³/₁₆" T: 2 ⁵/₁₆"
B: 3" M: 3 ⁵/₁₆"
2 Dz.



47017
Ballon Wine (16 Oz.)
H: 7 ³/₄" T: 3"
B: 3" M: 3 ¹⁵/₁₆"
2 Dz.



47026
Ballon Wine (20 Oz.)
H: 8 ¹/₄" T: 3 ³/₁₆"
B: 3 ¹/₄" M: 4 ³/₁₆"
2 Dz.



46981
Ballon Wine (24 Oz.)
H: 8 ¹/₁₆" T: 3 ³/₁₆"
B: 3 ¹/₄" M: 4 ¹/₂"
2 Dz.



E2788
Young Wine (12 Oz.)
H: 7 ⁷/₈" T: 2 ¹/₄"
B: 3 ³/₁₆" M: 3 ¹/₂"
2 Dz.
3 ¹/₂ Oz. pour line



E2790
Young Wine (16 Oz.)
H: 8 ¹/₂" T: 2 ⁵/₁₆"
B: 3 ¹/₄" M: 3 ¹³/₁₆"
2 Dz.
4 Oz. pour line



E2789
Young Wine (19 ¹/₂ Oz.)
H: 8 ⁷/₈" T: 2 ³/₄"
B: 3 ³/₁₆" M: 4 ¹/₈"
2 Dz.
5 ¹/₂ Oz. pour line



P0112
Millesime Wine (15 ³/₄ Oz.)
H: 8 ³/₈" T: 2 ³/₄"
B: 3 ¹/₄" M: 3 ⁵/₈"
2 Dz.

Cabernet *cont'd.*



V5794
Cordial (2 1/4 Oz.)
H: 5 1/4" T: 1 3/8"
B: 2" M: 1 7/8"
2 Dz.



14798
Port (4 Oz.)
H: 5 7/8" T: 1 5/8"
B: 2" M: 2 1/8"
2 Dz.



48024*
Flute (6 Oz.)
H: 8 7/8" T: 2"
B: 2 3/4" M: 2 1/4"
2 Dz.



D0796*
Flute (8 Oz.)
H: 9 1/4" T: 2"
B: 2 3/4" M: 2 7/8"
2 Dz.



G3573
All Purpose (13 1/2 Oz.)
H: 6 3/8" T: 2 7/8"
B: 3 1/8" M: 3 3/8"
2 Dz.



G3570
Iced Tea (16 Oz.)
H: 7 7/8" T: 2 5/8"
B: 3 1/8" M: 3 3/8"
2 Dz.



P3882
Cocktail (7 1/2 Oz.)
H: 6 3/4" T: 4 1/2"
B: 3" M: 4 1/2"
1 Dz.



N6831
Cocktail (10 Oz.)
H: 7 1/2" T: 4 3/4"
B: 3" M: 4 3/4"
1 Dz.



N6815
Champagne Coupe (10 Oz.)
H: 6 3/4" T: 4 3/8"
B: 2 7/8" M: 4 5/8"
1 Dz.





Shown Double Old Fashioned (12 ½ Oz.) | Rocks (10 ½ Oz.) | Beverage (15 Oz.)



L2369
Beverage (15 Oz.)
H: 6 ½" T: 2 ¾"
B: 2 ¼" M: 2 ¾"
2 Dz.



G3674
Beverage (11 ½ Oz.)
H: 4 ¾" T: 2 ½"
B: 2 ½" M: 2 ½"
2 Dz.



G3658
Hi Ball (7 ¾ Oz.)
H: 4 ¾" T: 2 ¼"
B: 1 ¾" M: 2 ¾"
2 Dz.



L2370
Double Old Fashioned (12 ½ Oz.)
H: 3 ½" T: 3 ¾"
B: 2 ¾" M: 3 ½"
2 Dz.



G3666
Rocks (10 ½ Oz.)
H: 3 ¼" T: 3 ¾"
B: 2 ¾" M: 3 ¾"
2 Dz.



G3659
Rocks (7 Oz.)
H: 2 ¾" T: 2 ¾"
B: 2 ¾" M: 2 ¾"
2 Dz.



Exalt

The alliance between perfect curves and incredible resistance coupled with the harmony of continuous and elegant lines.



E7698
Wine (6 ¾ Oz.)
H: 7 ¼" T: 2 ¼"
B: 2 ¾" M: 2 ¾"
2 Dz.



E7697
Wine (8 ¼ Oz.)
H: 7 ½" T: 2 ¾"
B: 2 ¾" M: 3"
2 Dz.



E7696
Wine (10 ½ Oz.)
H: 7 ⅞" T: 2 ½"
B: 3" M: 3 ¼"
2 Dz.



E7695
Wine (13 ¾ Oz.)
H: 8 ½" T: 2 ¾"
B: 3 ⅞" M: 3 ½"
2 Dz.



E7700*
Flute (6 ¼ Oz.)
H: 8 ¼" T: 2"
B: 2 ¾" M: 2 ¾"
2 Dz.



SHEER RIM
1.2 mm



Evidence ^{NEW}

The versatile design of Evidence can effortlessly interchange between wine, cocktail, mocktails or even specialty brews! The low profile design makes it a great choice for banquets.





V2821
 Wine (15 ½ Oz.)
 H: 8 ¼" T: 2 ½"
 B: 3" M: 3 ¾"
 2 Dz.



V2620
 Wine (12 Oz.)
 H: 7 ½" T: 2 ¾"
 B: 2 ¾" M: 2 ¾"
 2 Dz.



V2822
 Wine (9 Oz.)
 H: 7" T: 2 ¾"
 B: 2 ¾" M: 2 ¾"
 2 Dz.



V2823*
 Flute (5 ½ Oz.)
 H: 7 ½" T: 1 ¾"
 B: 2 ¾" M: 2 ¾"
 2 Dz.





Aska

Unique & sophisticated shape
to create a contemporary and
modern experience.



FP357
Tumbler (12 ¾ Oz.)
H: 4 7/8" T: 2 3/8" B: 3" M: 3"
4 Dz.



Lima

Modern angular shapes with sheer rims perfectly complement the Cabernet and Sublym collections.

Shown HI Ball (12 ¾ Oz.) | HI Ball (15 ½ Oz.)



G3367
Old Fashioned (11 ¾ Oz.)
H: 3 ¼" T: 2 ¾"
B: 2 ½" M: 3 ½"
2 Dz.



G3368
HI Ball (12 ¾ Oz.)
H: 4 ¼" T: 2 ½"
B: 1 ¾" M: 3 ¼"
2 Dz.



L8110
Beverage (13 ½ Oz.)
H: 5 ¾" T: 2 ½"
B: 2" M: 3"
2 Dz.



L2356
HI Ball (15 ½ Oz.)
H: 6 ½" T: 2 ¾"
B: 1 ¾" M: 2 ¾"
2 Dz.



Macaron

A classic glass with modern curves.
Perfect for wine, cocktails and beer.



N0834
Macaron Rocks (13 ½ Oz.)
H: 4" T: 2 ¾"
B: 2" M: 3 ½"
2 Dz.



Primary

Multipurpose glassware for wine, cocktails or beverage service. Complement with Cabernet Stemware.

Shown HI Ball (13 ½ Oz.)



G0036
Rocks (9 Oz.)
H: 3 ½" T: 2 ¼"
B: 1 ½" M: 2 ¾"
2 Dz.



G3322
Double Old Fashioned (12 Oz.)
H: 4" T: 2 ¾"
B: 1 ⅞" M: 3"
2 Dz.



L8677
HI Ball (13 ½ Oz.)
H: 5 ½" T: 2 ¼"
B: 1 ⅞" M: 3"
2 Dz.



G3323
Beverage (14 ¾ Oz.)
H: 4 ¼" T: 2 ¾"
B: 1 ⅞" M: 3 ¼"
2 Dz.



Architecte

Geometric art and sculpture in glass form. This paneled glass collection brings a sophisticated touch to your beverage service.



V7387
Rocks (10 ¾ Oz.)
H: 3 7/8" T: 3 1/2"
B: 2 3/4" M: 3 1/2"
8 Pcs.

Old SKU: Q4353



Macassar

Striking panel cuts bring a traditional touch to whiskey and cocktails with exceptional clarity.



Q4340
Hi Ball (12 Oz.)
H: 5" T: 3 1/4"
B: 2 1/2" M: 3 1/4"
1 Dz.



Rendez-vous

Contemporary multifaceted panel designs with outstanding brightness for beverage presentations.



Q4354
Rocks (10 ¾ Oz.)
H: 3 ¾" T: 3 ½"
B: 3" M: 3 ½"
1 Dz.



Q4358
Hi Ball (12 Oz.)
H: 5 ½" T: 3 ¼"
B: 2 ½" M: 3 ¼"
1 Dz.





Thermal strengthening after-process for rim reinforcement and chip resistance. All sheer rim glassware is reinforced with the ArmoRim process creating a refined experience for customers.

Mineral	72
Serena NEW	74
Romeo	76
V. Juliette	78
Malea Brio	80
Precision	81



Effervescence Plus – A technology that develops even, delicate bubbliness, delighting the eyes and taste buds alike.



Mineral

Tall sides and sheer rims suit nearly any wine.



H2090*
Flute (5 ¼ Oz.)
H: 8 ¾" T: 1 ¾"
B: 2 ½" M: 2 ⅛"
2 Dz.



H2317
Wine (11 ¾ Oz.)
H: 8 ⅝" T: 2 ⅝"
B: 3" M: 3 ⅛"
4 Dz.



H2318
Wine (15 Oz.)
H: 9 ¼" T: 2 ½"
B: 3" M: 3 ¼"
4 Dz.





Serena NEW

The classic shape of Serena is paired beautifully with a vertical line texture with a slight twist.



X0633
Flute (7 Oz.)
H: 9 3/8" T: 1 13/16"
B: 3" M: 2 1/2"
1 Dz.



X0631
Wine (16 Oz.)
H: 9 1/8" T: 2 1/2"
B: 3" M: 3 3/8"
1 Dz.



X0634
All Purpose Goblet (15 Oz.)
H: 6 3/4" T: 2 1/2"
B: 3" M: 3 1/2"
1 Dz.



X0635
Stemless Wine (11 Oz.)
H: 3 1/2" T: 2 3/8"
B: 2" M: 3 3/8"
1 Dz.



X0636
Stemless Wine (13 Oz.)
H: 4 1/2" T: 2 1/2"
B: 2" M: 3 1/4"
1 Dz.



Romeo

Romeo is the perfect blend of function and style. Offering an extensive line of shapes to suit your many needs.

Made with ArmoRim technology, the fine sheer rims offer strength and beauty.



P8793
 Flute (5 ¾ Oz.)
 H: 7 7/8" T: 2"
 B: 2 3/8" M: 2 1/8"
 1 Dz.



V2128
 Corkscrew Wine (16 Oz.)
 H: 8 3/8" T: 2 1/8"
 B: 3" M: 3 3/8"
 1 Dz.



P8794
Wine (12 Oz.)
H: 7 7/8" T: 2 1/2"
B: 3" M: 3 1/8"
1 Dz.



V2125
Wine (16 Oz.)
H: 8 3/8" T: 2 7/8"
B: 3" M: 3 3/8"
1 Dz.



P8790
Wine (19 Oz.)
H: 8 7/8" T: 2 7/8"
B: 3" M: 3 5/8"
1 Dz.



V4024
All Purpose (13 1/2 Oz.)
H: 6 5/8" T: 2 5/8"
B: 3" M: 2 7/8"
1 Dz.



P8782
All Purpose/ Beer (16 Oz.)
H: 7" T: 2 7/8"
B: 3" M: 3 1/4"
1 Dz.



V4222
Margarita (12 Oz.)
H: 6 1/8" T: 4 5/8"
B: 3" M: 4 5/8"
1 Dz.



V2761
Coupe Cocktail (8 Oz.)
H: 5 7/8" T: 4 1/8"
B: 3" M: 4 1/8"
1 Dz.



V2760
Cocktail (5 1/2 Oz.)
H: 5 5/8" T: 2 3/4"
B: 2 3/4" M: 2 3/4"
1 Dz.



V4025
Martini (5 Oz.)
H: 6" T: 3 3/4"
B: 2 3/4" M: 3 3/4"
1 Dz.



V. Juliette

The angular design of the V. Juliette collection offers a distinctive shape that fits very well with all table styles.



N5082*
Flute (7 ¾ Oz.)
H: 8 ½" T: 1 ⅞"
B: 2 ⅞" M: 2 ⅞"
2 Dz.





N5163
Wine (10 Oz.)
H: 7 ¾" T: 2 ½"
B: 2 ⅝" M: 3 ⅙"
2 Dz.



N4907
Wine (13 ½ Oz.)
H: 8 ⅙" T: 2 ¼"
B: 3" M: 3 ⅝"
2 Dz.



N5993
Wine (16 ¾ Oz.)
H: 8 ½" T: 2 ½"
B: 3 ⅙" M: 3 ⅝"
2 Dz.



N5994
Hi Ball (13 ½ Oz.)
H: 4 ⅜" T: 2 ½"
B: 2" M: 3 ½"
2 Dz.



N5995
Double Old Fashioned (11 ¾ Oz.)
H: 3 ¼" T: 3"
B: 2 ¼" M: 3 ¾"
2 Dz.





Malea Brio

Fine rims, sparkling bodies and flavor enhancing teardrop shapes at a great value.



H8466*
Brio Flute (3 Oz.)
H: 6 1/16" T: 1 7/8"
B: 2 1/8" M: 2 1/4"
2 Dz.



J1478*
Brio Flute (5 1/4 Oz.)
H: 7 7/8" T: 2 1/8"
B: 2 3/8" M: 2 5/8"
2 Dz.



Precision

This tumbler collection features a heavy sham, straight wall and sheer rim.

With a variety of pieces in the collection, Precision offers an elevated look at a valued price point.



P8500
Rocks (10 ½ Oz.)
H: 3 ¼" T: 3 ¼"
B: 3" M: 3 ¼"
1 Dz.



P8494
Collins/Beverage (13 Oz.)
H: 5 ¾" T: 2 ¾"
B: 2 ¾" M: 2 ¾"
1 Dz.



P8499
Cooler (16 Oz.)
H: 6 ½" T: 2 ½"
B: 2 ½" M: 2 ½"
1 Dz.





Fully Tempered – More resistant to mechanical and thermal shock than regular annealed glass; up to 5X more resistant to breakage.

Excalibur	84
Amelia	88
Artic	89
Starline <i>NEW</i>	90
Rock Line <i>NEW</i>	92
Rock Dew <i>NEW</i>	93
Prysm	94
Norvege	94
Mugs	95
Stack Up Cross <i>NEW</i>	96
Stack Up	98
Arcadie	100
Granite	102
Gotham	103
Essentials	104



Perfectly Stackable - Glassware designed to perfectly stack to optimize storage.

Excalibur

The workhorse of glassware.

More resistant to mechanical and thermal shock than regular annealed glass—up to 5X more resistant to breakage.



71084

Tall Wine (8 ½ Oz.)

H: 6 13⁄16" T: 2 3⁄8"

B: 2 3⁄4" M: 2 15⁄16"

3 Dz.

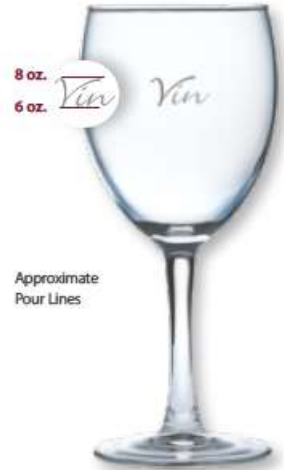

8 oz.
6 oz.

Approximate
Pour Lines

D1CM5312

Vin with pour line (12 Oz.)

H: 7 ½" T: 3" B: 3" M: 3 3⁄8"

2 Dz.



71083

Tall Wine (10 ½ Oz.)

H: 7 ¼" T: 2 7⁄8"

B: 2 ¾" M: 3 3⁄16"

3 Dz.



06942

Super Savoie (12 Oz.)

H: 7 ½" T: 3"

B: 3 1⁄8" M: 3 5⁄16"

2 Dz.



71080

Grand Savoie (12 Oz.)

H: 7 ½" T: 3"

B: 3" M: 3 3⁄8"

2 Dz.

**EXCALIBUR
BREEZE**



P0776
Breeze (11 ¾ Oz.)
H: 8" T: 2 ¾"
B: 3" M: 3 ½"
2 Dz.



71075
Grand Ballon (13 Oz.)
H: 6 7/8" T: 3 1/8"
B: 3" M: 3 3/8"
2 Dz.



L0371
Coupe Cocktail (8 Oz.)
H: 5 5/8" T: 4 3/8"
B: 3" M: 4 3/8"
2 Dz.



71086
Flute (5 ¾ Oz.)
H: 7 ¾" T: 2"
B: 2 ½" M: 2 ½"
3 Dz.



P0777
Breeze (15 ¾ Oz.)
H: 8 5/8" T: 2 3/4"
B: 3" M: 3 1/2"
2 Dz.



• 00213 Cocktail (10 Oz.)
H: 7 7/8" T: 4 3/8"
B: 3" M: 4 3/8"
1 Dz.

• 79320 Cocktail (10 Oz.)
H: 7 7/8" T: 4 3/8"
B: 3" M: 4 3/8"
1 Dz.



• D2024 Cocktail (7 ½ Oz.)
H: 6 3/4" T: 4 1/2"
B: 3" M: 4 1/2"
1 Dz.

• 09232 Cocktail (7 ½ Oz.)
H: 6 3/4" T: 4 1/2"
B: 3" M: 4 1/2"
1 Dz.



Excalibur *cont'd.*



12926
Iced Tea (16 ½ Oz.)
H: 7 ¾" T: 2 ¼"
B: 3" M: 3 ¼"
2 Dz.



04757
All Purpose Goblet (14 Oz.)
H: 6 ¾" T: 2 ¾"
B: 3" M: 3 ¾"
2 Dz.



71076
All Purpose Goblet (11 Oz.)
H: 6 ¼" T: 2 ½"
B: 3" M: 3 ½"
3 Dz.



07395
Ballon Goblet (11 ½ Oz.)
H: 5 ¾" T: 2 ¾"
B: 2 ¾" M: 3 ¼"
3 Dz.



71078
Banquet Goblet (11 ½ Oz.)
H: 5 ¼" T: 3"
B: 2 ¾" M: 3 ¾"
3 Dz.



71079
Brandy (12 Oz.)
H: 5 ¼" T: 2"
B: 2 ½" M: 2 ¾"
2 Dz.



71093
Petite Cuvee (13 Oz.)
H: 7" T: 2 ¾"
B: 3" M: 3 ¾"
2 Dz.



71081
Grand Cuvee (13 Oz.)
H: 8 ½" T: 2 ¾"
B: 3" M: 3 ¾"
2 Dz.



71092
Footed Hi Ball (8 Oz.)
H: 5 ¼" T: 2 ¾"
B: 2 ¾" M: 2 ¾"
3 Dz.



20875
Old Fashioned (7 Oz.)
H: 3 1/8" T: 3"
B: 2 1/8" M: 3"
3 Dz.



20874
Old Fashioned (9 Oz.)
H: 3 1/4" T: 3 1/4"
B: 2 5/8" M: 3 1/4"
3 Dz.



20873
Old Fashioned (10 1/2 Oz.)
H: 3 1/2" T: 3 7/8"
B: 2 1/2" M: 3 3/8"
3 Dz.



20871
Hi Ball (6 Oz.)
H: 4" T: 2 1/2"
B: 1 3/4" M: 2 1/2"
3 Dz.



20869
Hi Ball (8 Oz.)
H: 4 9/16" T: 2 9/16"
B: 1 7/8" M: 2 9/16"
3 Dz.



20868
Hi Ball (9 Oz.)
H: 4 3/4" T: 2 1/8"
B: 1 7/8" M: 2 1/8"
3 Dz.



20867
Hi Ball (10 1/2 Oz.)
H: 5 1/8" T: 2 13/16"
B: 2" M: 2 13/16"
3 Dz.



20866
Hi Ball (11 Oz.)
H: 5 1/4" T: 2 7/8"
B: 2" M: 2 7/8"
3 Dz.



20865
Beverage (12 1/2 Oz.)
H: 5 11/16" T: 2 7/8"
B: 2" M: 2 7/8"
3 Dz.



20864
Beverage (16 Oz.)
H: 6" T: 3 1/8"
B: 2 1/8" M: 3 1/8"
3 Dz.

Amelia

The perfectly stackable goblet,
Amelia is a bars best friend.



E3562
Stacking Goblet (8 ½ Oz.)
H: 4 ¾" T: 2 ¾"
B: 2 ½" M: 3 ½"
4 Dz.



Artic

The timeless cut design of Artic evokes feelings of nostalgia while exuding an air of elegance.



57286
Wine (8 Oz.)
H: 5 3/8" T: 3"
B: 2 7/8" M: 3"
4 Dz.



57070
Wine (10 1/2 Oz.)
H: 5 3/4" T: 3 1/8"
B: 2 7/8" M: 3 1/8"
4 Dz.



53664
Juice (6 Oz.)
H: 3 3/4" T: 2 1/4"
B: 1 5/8" M: 2 1/4"
4 Dz.



75926
Hi Ball (8 3/4 Oz.)
H: 4 3/8" T: 2 3/8"
B: 2" M: 2 5/8"
4 Dz.



D6315
Hi Ball (10 1/2 Oz.)
H: 5" T: 2 3/4"
B: 2" M: 2 3/4"
4 Dz.



57069
Beverage (12 1/2 Oz.)
H: 5 3/8" T: 2 7/8"
B: 2 1/4" M: 2 3/8"
4 Dz.



Starline NEW

Starline offers a timeless design with a modern touch. Its textured base, adorned with vertical lines, ensures an easy grip, while the clear top portion enhances its classic appeal.



V9573
Old Fashioned (10 Oz.)
H: 3 7/8" T: 3 3/8"
B: 2 3/8" M: 3 3/8"
2 Dz.



V9572
Hi Ball (12 1/2 Oz.)
H: 4 3/4" T: 3 3/8"
B: 2 1/2" M: 3 3/8"
2 Dz.



V9571
Hi Ball (11 Oz.)
H: 5 1/2" T: 3"
B: 2 1/2" M: 3"
2 Dz.



V9574
Beverage (14 Oz.)
H: 5 1/8" T: 3 1/2"
B: 2 1/2" M: 3 1/2"
2 Dz.



X0433
Beverage (16 Oz.)
H: 6" T: 3 1/2"
B: 2 1/2" M: 3 1/2"
2 Dz.



X0434
Beverage (22 Oz.)
H: 6 3/4" T: 3 3/4"
B: 2 3/4" M: 3 3/4"
1 Dz.





Rock Line NEW

Featuring bold vertical lines, adding both a refined look and enhanced grip. The fully tempered treatment adds exceptional durability for high-traffic environments, with colored options providing easy differentiation.



Clear

Blue

Pink



V7636
Rocks (12 Oz.)
H: 3 3/4" T: 3 3/8"
B: 2 1/4" M: 3 3/8"
2 Dz.



V7637
Hi Ball (12 1/4 Oz.)
H: 5 3/8" T: 3"
B: 2" M: 3"
2 Dz.



V8704
Blue Rocks (12 Oz.)
H: 3 3/4" T: 3 3/8"
B: 2 1/4" M: 3 3/8"
2 Dz.



V8705
Blue Hi Ball (12 1/4 Oz.)
H: 5 3/8" T: 3"
B: 2" M: 3"
2 Dz.



V8710
Pink Rocks (12 Oz.)
H: 3 3/4" T: 3 3/8"
B: 2 1/4" M: 3 3/8"
2 Dz.



V8711
Pink Hi Ball (12 1/4 Oz.)
H: 5 3/8" T: 3"
B: 2" M: 3"
2 Dz.

Rock Dew NEW

With a subtle textured pattern, this collection adds style and a comfortable grip. Fully tempered for durability, these tumblers are built for busy environments, and the colored options make it easy to differentiate between beverages.



Clear

Blue

Pink



V7638
Rocks (12 Oz.)
H: 3 3/4" T: 3 3/8"
B: 2 1/4" M: 3 3/8"
2 Dz.



V7639
Hi Ball (12 1/4 Oz.)
H: 5 3/8" T: 3"
B: 2" M: 3"
2 Dz.



V8706
Blue Rocks (12 Oz.)
H: 3 3/4" T: 3 3/8"
B: 2 1/4" M: 3 3/8"
2 Dz.



V8707
Blue Hi Ball (12 1/4 Oz.)
H: 5 3/8" T: 3"
B: 2" M: 3"
2 Dz.



V8712
Pink Rocks (12 Oz.)
H: 3 3/4" T: 3 3/8"
B: 2 1/4" M: 3 3/8"
2 Dz.



V8713
Pink Hi Ball (12 1/4 Oz.)
H: 5 3/8" T: 3"
B: 2" M: 3"
2 Dz.



Shown Beverage (12 Oz.)

Prysm

Slightly twisted square base collection with clean lines and optimal strength.



X0154
Rocks (9 Oz.)
H: 3 1/2" T: 3 3/8"
B: 2 3/4" M: 3 5/8"
2 Dz.

Old SKU: E1515



E1514
Double Old Fashioned (12 1/2 Oz.)
H: 3 3/4" T: 4"
B: 3" M: 4"
4 Dz.



X0422
Beverage (12 Oz.)
H: 5" T: 3 1/2"
B: 2 1/2" M: 3 1/2"
2 Dz.

Old SKU: E1513



H0736
Cooler (16 Oz.)
H: 5 3/4" T: 3 3/4"
B: 2 3/4" M: 3 3/4"
4 Dz.

Norvege

Classic and stackable, Norvege features vertical lines.



V7462
Old Fashioned (6 1/2 Oz.)
H: 3 1/2" T: 2 3/4"
B: 2 1/8" M: 2 3/4"
2 Dz.



V7535
Old Fashioned (8 1/2 Oz.)
H: 3 5/8" T: 3"
B: 2 1/4" M: 3"
2 Dz.

Old SKU: 61697



V7529
Hi Ball (9 1/2 Oz.)
H: 4 1/2" T: 2 3/4"
B: 2" M: 2 3/4"
2 Dz.



V7527
Beverage (10 3/4 Oz.)
H: 5" T: 2 7/8"
B: 2 1/2" M: 2 7/8"
2 Dz.

Old SKU: 61698



Mugs

Fully-tempered for hot drinks, clear glass mugs add a beautiful visual for a delicious hot beverage.



V7483
Mug (8 ½ Oz.)
H: 3 ½" T: 2 ¾"
B: 2 ¾" M: 4 ¼"
6 Pcs.



D9219
Nordic Mug (12 ½ Oz.)
H: 3 ¾" T: 3 ¼"
B: 3 ½" M: 4 ¾"
2 Dz.



37684
Irish Coffee (8 ½ Oz.)
H: 5 ½" T: 3"
B: 2 ¼" M: 3 ½"
2 Dz.



11874
Irish Coffee (10 Oz.)
H: 5 ¾" T: 2 ¾"
B: 2 ¾" M: 4"
2 Dz.



53403
Irish Coffee (10 Oz.)
Non-Tempered
H: 5 ¾" T: 2 ¾"
B: 2 ¾" M: 4"
2 Dz.



Shown Mug (8 ½ Oz.)



Stack Up Cross NEW

Superior stackability and textured design helps to differentiate while remaining trendy. Mix and match with the Stack Up collection!



V4140
Rocks (7 Oz.)
H: 3 1/8" T: 3 1/4"
B: 2 3/8" M: 3 1/4"
2 Dz.



V4139
Rocks (8 3/4 Oz.)
H: 3 5/8" T: 3 3/8"
B: 2 1/4" M: 3 3/8"
2 Dz.



V4138
Hi Ball (11 3/4 Oz.)
H: 5 1/2" T: 3 1/8"
B: 2 1/8" M: 3 1/8"
2 Dz.



Stack Up

Superior stackability makes this a go-to choice for space savings.



Shown Double Old Fashioned (12 Oz.)



H3858
Rocks (7 Oz.)
H: 3 1/8" T: 3 1/4"
B: 2 3/8" M: 3 1/4"
1 Dz.



L5216
Old Fashioned (8 3/4 Oz.)
H: 3 3/8" T: 3 3/8"
B: 2 1/4" M: 3 3/8"
2 Dz.



H3032
Old Fashioned (10 1/2 Oz.)
H: 3 3/8" T: 3 3/8"
B: 2 1/2" M: 3 3/8"
1 Dz.



H5169
Double Old Fashioned (12 Oz.)
H: 3 7/8" T: 3 3/8"
B: 2 3/4" M: 3 5/8"
1 Dz.



H3839
Hi Ball (10 Oz.)
H: 5 3/8" T: 2 7/8"
B: 2 1/8" M: 2 7/8"
1 Dz.



L5217
Hi Ball (11 3/4 Oz.)
H: 5 1/2" T: 3 1/8"
B: 2 1/8" M: 3 1/8"
2 Dz.



H3856
Beverage (14 Oz.)
H: 5 3/8" T: 3 1/4"
B: 2 1/4" M: 3 1/4"
1 Dz.



H3089
Cooler (16 Oz.)
H: 5 3/4" T: 3 3/8"
B: 2 3/8" M: 3 3/8"
1 Dz.



H3008
Cooler (21 Oz.)
H: 6 3/8" T: 3 3/8"
B: 2 3/8" M: 3 3/8"
1 Dz.



Arcadie

The soft, delicate panels of the Arcadie collection offer a sense of simplicity.

The versatility of the line allows for easy cross functional service and the nestable design adds for easy space saving.





Q2233
Rocks (3 Oz.)
H: 2 1/2" T: 2 7/16"
B: 1 1/4" M: 2 7/16"
2 Dz.



Q2234
Rocks (5 1/4 Oz.)
H: 3" T: 3"
B: 1 13/16" M: 3"
2 Dz.



Q2967
Rocks (8 Oz.)
H: 3 3/8" T: 3 5/16"
B: 2" M: 3 7/16"
2 Dz.



Q2750
Double Old Fashioned (11 3/4 Oz.)
H: 3 7/8" T: 3 3/4"
B: 2 3/8" M: 3 3/4"
2 Dz.



Q2751
Hi Ball (13 1/2 Oz.)
H: 5" T: 3 1/16"
B: 2 1/4" M: 3 11/16"
2 Dz.



Q3700
Saucer
D: 4 1/2"
2 Dz.
Fits: Q2967, Q2234, Q2233



Q3701
Saucer
D: 5 1/2"
2 Dz.
Fits: Q2751, Q2750





Shown Cooler (12 Oz.), Tall Rocks (9 Oz.)

Granite

Perfectly stackable, Granite is a multi-faceted, cafe-inspired glass.



J2610
Rocks (5 ¼ Oz.)
H: 3" T: 2 ¾"
B: 2 ¾" M: 2 ¾"
4 Dz.



J2611
Rocks (7 Oz.)
H: 3 ¼" T: 3 ½"
B: 2 ¼" M: 3 ½"
2 Dz.



L7844
Double Old Fashioned (11 ¾ Oz.)
H: 4 ¼" T: 3 ¾"
B: 2 ¾" M: 3 ¾"
2 Dz.



V8924
Tall Rocks (9 Oz.)
H: 3 ¾" T: 3 ¾"
B: 2 ¾" M: 3 ¾"
3 Dz.



J2605
Beverage (10 ½ Oz.)
H: 5 ½" T: 2 ¾"
B: 2 ¾" M: 2 ¾"
2 Dz.



43281
Beverage (16 Oz.)
H: 6 ¾" T: 3 ¾"
B: 2 ½" M: 3 ¾"
3 Dz.



43279
Cooler (12 Oz.)
H: 4 ¾" T: 3 ¼"
B: 2 ¾" M: 3 ¼"
3 Dz.



J2603
Cooler (14 Oz.)
H: 5 ½" T: 3 ½"
B: 2 ¾" M: 3 ½"
2 Dz.



Gotham

Our classic, multi-faceted design adds a splash of European café culture.



J4094
Rocks (4 ½ Oz.)
H: 3 ¼" T: 2 ¾"
B: 1 ¾" M: 2 ¾"
3 Dz.



J4096
Rocks (8 Oz.)
H: 3 ½" T: 3 ¼"
B: 2 ¼" M: 3 ½"
3 Dz.



J4097
Rocks (9 Oz.)
H: 3 ½" T: 3 ¼"
B: 2 ¼" M: 3 ⅝"
3 Dz.



J4099
Double Old Fashioned (12 Oz.)
H: 3 ¾" T: 3 ½"
B: 2 ½" M: 3 ½"
3 Dz.



J4101
Beverage (10 Oz.)
H: 4 ¾" T: 3"
B: 2 ¼" M: 3 ⅝"
3 Dz.



J4102
Beverage (12 Oz.)
H: 4 ¾" T: 3 ¼"
B: 2 ½" M: 3 ¼"
3 Dz.



J4103
Beverage (14 Oz.)
H: 5 ½" T: 3 ½"
B: 2 ½" M: 3 ½"
3 Dz.



J4104
Cooler (16 Oz.)
H: 6 ¼" T: 3 ½"
B: 2 ½" M: 3 ½"
3 Dz.

Essentials

A sleek and sophisticated barware line that features a slimming perspective and thin base.





V3871
Rocks (7 ½ Oz.)
H: 2 ¾" T: 3 ¼"
B: 2 ⅞" M: 3 ¼"
1 Dz.



15012
Hi Ball (10 ½ Oz.)
H: 6 ½" T: 2 ⅞"
B: 2 ⅞" M: 2 ¼"
2 Dz.



Q1774
Collins (13 Oz.)
H: 6 ⅞" T: 2 ¾"
B: 2 ¼" M: 2 ¾"
1 Dz.



V3470
Rocks (12 ½ Oz.)
H: 3 ½" T: 3 ¼"
B: 2 ⅞" M: 3 ¼"
2 Dz.



N8901*
Grey Rocks (12 ½ Oz.)
H: 3 ½" T: 3 ¼"
B: 2 ⅞" M: 3 ¼"
6 Pcs.



V3473
Beverage (17 Oz.)
H: 4 ⅞" T: 3 ½"
B: 2 ¾" M: 3 ⅞"
2 Dz.





HIGH RIM RESISTANCE

ArmoRim - Thermal strengthening after-process for rim reinforcement and chip resistance.

Urbane

108



Perfectly Stackable - Glassware designed to perfectly stack to optimize storage.



Urbane

Long profile designs with slight curves and sturdy bottoms for increased durability at the bar. Built with a stackable ledge for efficient space saving.



N0529
Whiskey/Shot (3 1/2 Oz.)
H: 3" T: 2 5/8"
B: 1 5/8" M: 2 5/8"
1 Dz.



N0523
Rocks (5 Oz.)
H: 3 1/4" T: 2 7/8"
B: 1 3/4" M: 2 7/8"
1 Dz.



N0530
Rocks (7 Oz.)
H: 3 5/8" T: 3 1/8"
B: 2" M: 3 1/8"
1 Dz.



N0531
Rocks (9 Oz.)
H: 3 7/8" T: 3 1/2"
B: 2 1/4" M: 3 1/2"
1 Dz.



N0512
Rocks (10 Oz.)
H: 4" T: 3 1/2"
B: 2 1/4" M: 3 1/2"
1 Dz.



N0524
Double Old Fashioned (12 Oz.)
H: 4 5/8" T: 3 3/4"
B: 2 3/8" M: 3 3/4"
1 Dz.



N0527
Double Old Fashioned (14 Oz.)
H: 4 1/4" T: 3 7/8"
B: 2 1/2" M: 3 7/8"
1 Dz.



N0513
Hi Ball (10 Oz.)
H: 6 1/4" T: 2 7/8"
B: 2" M: 2 7/8"
1 Dz.



N0521
Beverage (12 Oz.)
H: 6 1/4" T: 3"
B: 2 1/8" M: 3"
1 Dz.



N0528
Beverage (14 Oz.)
H: 6 5/8" T: 3 1/4"
B: 2 1/4" M: 3 1/4"
1 Dz.



N0520
Cooler (16 Oz.)
H: 7" T: 3 3/8"
B: 2 3/8" M: 3 3/8"
1 Dz.







EVERYDAY CLASSICS

A glass for every occasion. Discover the limitless possibilities with Arcoroc's glassware collections, where creativity and customer desires take center stage. Embracing both practicality and functionality, our glassware encourages you to unleash your imagination. Create extraordinary moments, curate unforgettable experiences, and celebrate in style. No matter the occasion, let us help you make it a remarkable one.

Monti <i>NEW</i>	112
Broadway	114
Luxe <i>NEW</i>	116
Salto	117
Brixton <i>NEW</i>	118
Imperator <i>NEW</i>	119
Elysees <i>NEW</i>	119
Quadrille <i>NEW</i>	119
Islande	120
Shetland	122
Cabernet	123
Mason Jar	124
Perfection	124
Aristocrat	125
Cooler	126
Wine Bottom Tumblers	127
ARCOPRIME	
Universal	128
Straight Sided	128



Monti NEW

The classic, ornate stem of the Monti collection will transport you back to the good old days. Serve your classic cocktails with a twist, whether that's the addition of low-proof bitters or other unexpected ingredients!



Q8201
Coupe (9 Oz.)
H: 6" T: 3 1/8"
B: 3" M: 3 1/2"
1 Dz.



Q8701
Cocktail (9 Oz.)
H: 6 3/4" T: 3 1/8"
B: 2 1/2" M: 3 1/8"
1 Dz.



Q1325
Martini (7 Oz.)
H: 6 1/8" T: 4 1/2"
B: 3" M: 4 1/2"
1 Dz.

Broadway

Strikingly beautiful cut glass adds stylish sophistication to your beverage service with a vintage touch.





Q7932
Vintage Cocktail (8 ¼ Oz.)
H: 7 ¾" T: 3 ½"
B: 2 ¾" M: 3 ½"
2 Dz.



P8795
Cocktail (7 Oz.)
H: 6 ½" T: 4 ½"
B: 3" M: 4 ½"
1 Dz.



P8796
Coupe Cocktail (8 Oz.)
H: 5 ½" T: 4 ½"
B: 3" M: 4 ½"
1 Dz.



P8821
Gin Cocktail (19 ½ Oz.)
H: 7 ½" T: 4 ¼"
B: 3 ¼" M: 4 ¼"
1 Dz.



V2910
Shot (2 Oz.)
H: 2 ¾" T: 1 ¾"
B: 1 ½" M: 1 ¾"
2 Dz.



FP320
Rocks (7 ½ Oz.)
H: 3 ½" T: 3"
B: 2 ¾" M: 3"
2 Dz.



L7254
Rocks (10 ½ Oz.)
H: 3 ½" T: 3 ¾"
B: 3" M: 3 ¾"
2 Dz.



V5996
Mauve Rocks (10 ½ Oz.)
H: 3 ½" T: 3 ¾"
B: 3" M: 3 ¾"
2 Dz.



V5998
Blue Rocks (10 ½ Oz.)
H: 3 ½" T: 3 ¾"
B: 3" M: 3 ¾"
2 Dz.



FP321
Double Rocks (12 ½ Oz.)
H: 3 ¾" T: 3 ¾"
B: 2 ¾" M: 3 ¾"
2 Dz.



L7256
Hi Ball (9 ¼ Oz.)
H: 5 ¼" T: 2 ¾"
B: 2 ¼" M: 2 ¾"
2 Dz.



L7255
Hi Ball (12 Oz.)
H: 5 ¾" T: 3"
B: 2 ½" M: 3"
2 Dz.



P1470
Beverage (15 Oz.)
H: 6 ½" T: 3 ½"
B: 2 ¾" M: 3 ½"
2 Dz.



FP332
Beaker (24 Oz.)
H: 6" T: 4 ¾"
B: 3 ¾" M: 4 ¾"
6 Pcs.

Luxe NEW

The strong vertical lines of Luxe add a stylish touch and provide a secure grip. The cut design elevates the drinking experience by highlighting and intensifying the bold, complex flavors of the beverages served.



FP683
Rocks (10 ½ Oz.)
H: 3 ¾" T: 3 ¼"
B: 3 ¼" M: 3 ¼"
2 Dz.



FP684
Hi Ball (12 Oz.)
H: 6" T: 2 ¾"
B: 2 ¾" M: 2 ¾"
2 Dz.



Salto

The elegant arched sides creates a glass that fits perfectly in all hands.



Shown HI Ball (11 ¾ Oz.)



V3870
Cordial (2 Oz.)
H: 2 ½" T: 1 ⅞"
B: 1 ⅜" M: 1 ⅞"
4 Dz.



G2562
Rocks (10 ¾ Oz.)
H: 3 ¼" T: 3 ⅞"
B: 2 ¼" M: 3 ½"
4 Dz.



N5812
Hi Ball (11 ¾ Oz.)
H: 4 ¾" T: 2 ½"
B: 1 ⅞" M: 3"
2 Dz.



N5828
Cooler (17 Oz.)
H: 5 ¾" T: 2 ½"
B: 2" M: 3 ⅞"
2 Dz.

Brixton NEW

The strong vertical and horizontal lines of Brixton offer a unique design for an elevated experience.



Shown Double Rocks (12 ½ Oz.)



P4188
Rocks (10 ½ Oz.)
H: 4 T: 3 ¼" B: 2 ¾" M: 3 ¼"
1 Dz.



P9067
Double Rocks (12 ½ Oz.)
H: 4 ¾" T: 3 ¾" B: 2 ¾" M: 3 ¾"
2 Dz.



Q8947
Hi Ball (10 ½ Oz.)
H: 6" T: 2 ¼" B: 2 ¼" M: 2 ¼"
1 Dz.



Imperator, Elysees NEW *& Quadrille*



The classic designs of Imperator, Elysees, and Quadrille are sure to make a statement. Each glass features a traditional cut glass design that is both timeless and sophisticated, perfect for enhancing the presentation of fine spirits.



V8953
Imperator Old Fashioned (10 ¼ Oz.)
H: 3 ¾" T: 3 ¼"
B: 2 ½" M: 3 ¼"
2 Dz.



V8954
Elysees Old Fashioned (10 ½ Oz.)
H: 3 ¾" T: 3 ½"
B: 2 ¾" M: 3 ½"
2 Dz.



V8956
Quadrille Old Fashioned (10 ¼ Oz.)
H: 3 ½" T: 3 ¼"
B: 2 ¾" M: 3 ¼"
2 Dz.

Islande

A clean profile coupled with a heavy sham makes this line ideal for both casual gatherings and formal events. The heavy sham adds stability and perceived value.



Shown Double Old Fashioned (12 ¾ Oz.) | Collins (13 Oz.) | HI Ball (15 ½ Oz.)



Q5761
Cordial (2 ¼ Oz.)
H: 4 ½" T: 1 ½"
B: 1 ¾" M: 1 ½"
4 Dz.



J4238
Whiskey (3 ¼ Oz.)
H: 3 7/8" T: 2"
B: 1 7/8" M: 2"
2 Dz.



N6643
Juice (5 ¼ Oz.)
H: 4" T: 2 1/8"
B: 2" M: 2 1/8"
2 Dz.



D0616
Old Fashioned (7 Oz.)
H: 3 ¼" T: 2 ¾"
B: 2 5/8" M: 2 ¾"
4 Dz.



12652
Old Fashioned (8 ½ Oz.)
H: 3 3/8" T: 3 3/8"
B: 3" M: 3 1/8"
4 Dz.



V3469
Old Fashioned (10 Oz.)
H: 3 5/8" T: 3 1/8"
B: 3" M: 3 1/8"
2 Dz.



V3476
Double Old Fashioned (12 ¾ Oz.)
H: 3 3/4" T: 3 1/2"
B: 3 3/8" M: 3 1/2"
2 Dz.



V3472
Hi Ball (10 Oz.)
H: 5 5/8" T: 2 1/2"
B: 2 1/4" M: 2 1/2"
2 Dz.



D0575
Hi Ball (11 Oz.)
H: 6 1/2" T: 2 3/8"
B: 2 1/8" M: 2 3/8"
4 Dz.



V3475
Collins (13 Oz.)
H: 6 3/4" T: 2 1/2"
B: 2 1/4" M: 2 1/2"
2 Dz.



Q7781
Hi Ball (15 ½ Oz.)
H: 6 1/4" T: 2 7/8"
B: 2 1/2" M: 2 7/8"
1 Dz.



Shetland

Shetland, a true icon of versatility, seamlessly transforms from water to beer or cocktail service with its adaptable design. The heavy sham adds value and stability.

Shown Hi Ball (12 Oz.)



V5926
Old Fashioned (8 ½ Oz.)
H: 3 ½" T: 3 ½"
B: 2 ¾" M: 3 ½"
2 Dz.



E1907
Old Fashioned (10 ¾ Oz.)
H: 3 ⅞" T: 3 ¾"
B: 2 ½" M: 3 ¾"
4 Dz.



V5985
Hi Ball (7 ½ Oz.)
H: 4 ¾" T: 2 ⅞"
B: 1 ¾" M: 2 ⅞"
4 Dz.

Old SKU: 79736



V5927
Hi Ball (12 Oz.)
H: 5 ½" T: 3 ¼"
B: 2" M: 3 ¼"
4 Dz.



G3611
Hi Ball (14 Oz.)
H: 5 ¾" T: 3 ⅞"
B: 2 ⅞" M: 3 ⅞"
4 Dz.

Cabernet

Curved and simple, Cabernet is the perfect complement to Arcoroc stemware.



Shown Cooler (17 Oz.)



47346
Cordial (2 ½ Oz.)
H: 3 ½" T: 1 ½"
B: 1 ¾" M: 1 ⅝"
4 Dz.



10007
Rocks (10 ½ Oz.)
H: 3 ¼" T: 3 ⅞"
B: 2 ¾" M: 3 ⅝"
3 Dz.



17198
Cooler (17 Oz.)
H: 5 ⅞" T: 2 ¾"
B: 2 ½" M: 3 ⅞"
1 Dz.



Mason Jar

A classic jar design perfect for serving unique cocktails, soft drinks, beer or desserts! Versatile vessel with a rustic aesthetic.



FK203
Mason Jar with Handle (16 ½ Oz.)
H: 5 ¼" T: 2 ¾"
B: 2 ⅝" M: 4 ⅛"
1 Dz.

Perfection

Embrace the charm and versatility of the Perfection collection. Seamlessly transition from cocktails to water service to wine.



C8832
Tumbler (9 Oz.)
H: 3 ¾" T: 2 ¼"
B: 1 ½" M: 2 ¾"
1 Dz.



P6284
Tumbler (12 Oz.)
H: 4 ⅝" T: 2 ½"
B: 1 ¾" M: 3 ⅝"
1 Dz.



C8303
Tumbler (15 Oz.)
H: 4 ¾" T: 2 ⅝"
B: 1 ⅞" M: 3 ⅝"
1 Dz.



C8304
Tumbler (21 Oz.)
H: 5" T: 3"
B: 2 ¼" M: 3 ½"
1 Dz.



H4870
Flute (9 Oz.)
H: 5 ⅝" T: 2 ⅞"
B: 1 ½" M: 2 ⅞"
1 Dz.



Aristocrat

Classic clean, straight walled Aristocrat is the perfect all around tumbler. From in-room to old fashioned cocktails, Aristocrat is versatile and sleek.



53224
Old Fashioned (10 ½ Oz.)
H: 3 ½" T: 3 ¾"
B: 3" M: 3 ¾"
3 Dz.



53232
Double Old Fashioned (14 Oz.)
H: 4 ¼" T: 3 ¾"
B: 3 ½" M: 3 ¾"
3 Dz.



53205
Beverage (13 Oz.)
H: 5 ½" T: 2 ¾"
B: 2 ½" M: 2 ¾"
3 Dz.



53214
Cooler (16 Oz.)
H: 6 ¼" T: 2 ¾"
B: 2 ½" M: 2 ¾"
3 Dz.

Cooler

Meet your universal glassware companion. Whether it's a frothy beer or trendy cocktail, this glass can serve it all.



D0130
Cooler (14 ½ Oz.)
H: 6 ¾" T: 2 ¾"
B: 2" M: 2 7/8"
2 Dz.



E5458
Can Cooler (16 Oz.)
H: 5 ¼" T: 2 ¾"
B: 2 ½" M: 3"
3 Dz.



L4865
Tall Can Cooler (16 Oz.)
H: 6 ½" T: 2 ¼"
B: 2 ½" M: 2 ¾"
2 Dz.



Shown Can Cooler (16 Oz.)

Wine Bottom Tumblers

The Art of Upcycling. The wine bottle design repurposed into a unique drinking vessel for a memorable beverage presentation. The distinctive base indentation gives a rustic appeal to this charming drinking glass.



FJ060
Clear Tumbler (12 Oz.)
H: 4" T: 3"
B: 3" M: 3"
1 Dz.



FJ061
Clear Tumbler (16 Oz.)
H: 5 1/2" T: 3"
B: 3" M: 3"
1 Dz.



FK258
Green Tumbler (12 Oz.)
H: 4" T: 3"
B: 3" M: 3"
1 Dz.



FK259
Green Tumbler (16 Oz.)
H: 5 1/2" T: 3"
B: 3" M: 3"
1 Dz.



FJ063
Amber Tumbler (12 Oz.)
H: 4" T: 3"
B: 3" M: 3"
1 Dz.



FJ062
Amber Tumbler (16 Oz.)
H: 5 1/2" T: 3"
B: 3" M: 3"
1 Dz.





Q2518
 Universal Wine (12 Oz.)
 H: 7 1/8" T: 2 1/2"
 B: 2 1/8" M: 3 3/8"
 1 Dz.



Q2517
 Universal Wine (16 Oz.)
 H: 8 3/4" T: 2 3/4"
 B: 3 1/8" M: 3 3/8"
 1 Dz.



Q2505
 Universal Wine (19 Oz.)
 H: 9 1/8" T: 2 1/8"
 B: 3 1/8" M: 3 1/8"
 1 Dz.



Q2504
 Flute (5 3/4 Oz.)
 H: 7 1/8" T: 1 1/8"
 B: 2 5/8" M: 2 3/8"
 1 Dz.



Q2540
 Straight Sided OF (7 1/2 Oz.)
 H: 3 1/2" T: 2 7/8"
 B: 2 5/8" M: 2 1/8"
 1 Dz.



Q2539
 Straight Sided OF (10 1/2 Oz.)
 H: 3 1/2" T: 3 3/8"
 B: 3" M: 3 3/8"
 1 Dz.



Q2538
 Straight Sided DOF (14 Oz.)
 H: 4 1/8" T: 3 3/8"
 B: 3 1/8" M: 3 3/8"
 1 Dz.



Q2537
 Straight Sided Cooler (13 Oz.)
 H: 5 1/2" T: 2 7/8"
 B: 2 1/2" M: 2 7/8"
 1 Dz.



Q2536
 Straight Sided Beverage (16 Oz.)
 H: 6 1/4" T: 2 7/8"
 B: 2 1/2" M: 2 7/8"
 1 Dz.



Q2542
 Mixing Glass (16 Oz.)
 H: 5 3/4" T: 3 1/2"
 B: 2 3/8" M: 3 1/2"
 2 Dz.







Occasion

Glassware for any occasion, from buffet, cocktail experiences, beer garden to in-room service.

Sparkling Wine	132
Spirits	138
Beer	152
In-Room Tumblers	161
Decanters & Carafes	162
Mix	166
Outdoor Perfect	170



Krysta® – High-performance crystal glass. Superior strength, complete transparency, long-lasting brilliance and perfect acoustics.



Fully Tempered – More resistant to mechanical and thermal shock than regular annealed glass; up to 5X more resistant to breakage.



Perfectly Stackable - Glassware designed to perfectly stack to optimize storage.



Head Booster - Technology and textured bottom that boosts a beers head and keeps the head longer for a better drinking experience.



S.A.N. Plastic - Fully recyclable, BPA-Free with water vents at the bottom to allow for proper drainage.



ArmorRim + Sheer Rim - Thermal strengthening after-process for rim reinforcement and chip resistance.





SPARKLING WINE

Sparkling Wine



NEW

FP633 •
Grace Flute (8 Oz.)
H: 9 1/2" T: 1 3/16"
B: 2 3/4" M: 2 5/16"
2 Dz.



NEW

V2697 •
Symétrie Flute (7 1/2 Oz.)
H: 9 1/2" T: 2 1/2"
B: 2 3/4" M: 2 1/4"
2 Dz.



NEW

Q9080 •
Distinction Flute (7 3/4 Oz.)
H: 9 1/2" T: 1 3/4"
B: 2 3/4" M: 2 5/8"
2 Dz.



Q1151 •
Exaltation Flute (10 1/4 Oz.)
H: 8 3/8" T: 2 3/16"
B: 2 7/8" M: 3 1/16"
2 Dz.



NEW

FP303 •
Zephyr Specialty Cocktail (7 1/2 Oz.)
H: 6 1/2" T: 4 1/8"
B: 3 1/8" M: 4 3/8"
2 Dz.

NEW



V2823*
Evidence Flute (5 ½ Oz.)
H: 7 ½" T: 1 ¾"
B: 2 ⅞" M: 2 ⅜"
2 Dz.



48024*
Cabernet Flute (6 Oz.)
H: 8 ⅞" T: 2"
B: 2 ¾" M: 2 ¼"
2 Dz.



L5640*
Sequence Flute (6 Oz.)
H: 8 ¼" T: 1 ⅞"
B: 2 ¾" M: 2 ¼"
1 Dz.



E7700*
Exalt Flute (6 ¼ Oz.)
H: 8 ¼" T: 2"
B: 2 ¾" M: 2 ⅜"
2 Dz.



L2762*
Sublym Flute (7 ½ Oz.)
H: 9 ½" T: 1 ¾"
B: 2 ¾" M: 2 ¼"
2 Dz.

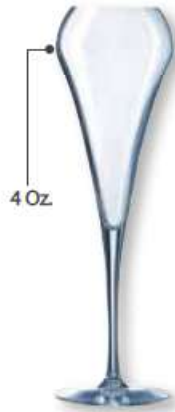

U1051*
Open Up Flute (6 ¾ Oz.)
H: 9" T: 2 ⅞"
B: 2 ⅞" M: 2 ¾"
2 Dz. | 4 Oz. Pour Line



D0796*
Cabernet Flute (8 Oz.)
H: 9 ¼" T: 2"
B: 2 ¾" M: 2 ⅞"
2 Dz.



J8907*
Reveal' Up Soft Flute (8 Oz.)
H: 9 ¼" T: 1 ¾"
B: 2 ¾" M: 2 ⅞"
2 Dz.



L3678
Sublym Coupe Cocktail (8 Oz.)
H: 7 ⅞" T: 4 ½"
B: 3" M: 4 ½"
2 Dz.



Q7785*
Coupe Cocktail (7 Oz.)
H: 6" T: 3 ⅞"
B: 2 ¾" M: 3 ⅞"
2 Dz.



L5641
Sequence Coupe Cocktail (7 ¾ Oz.)
H: 5 ⅞" T: 4 ⅜"
B: 3" M: 4 ⅜"
1 Dz.



J8908*
Reveal Up Soft Wine (11 Oz.)
H: 8 ½" T: 2"
B: 3" M: 3 ¼"
2 Dz.





H8466* •
Malea Brio Flute (3 Oz.)
H: 6 1/16" T: 1 1/8"
B: 2 1/8" M: 2 1/4"
2 Dz.



J1478* •
Malea Brio Flute (5 1/4 Oz.)
H: 7 7/8" T: 2 1/8"
B: 2 3/8" M: 2 3/8"
2 Dz.



E6125 •
Outdoor Perfect Flute (5 Oz.)
H: 8 ½" T: 2"
B: 2 ¾" M: 2 ¼"
3 Dz.



H2090* •
Mineral Flute (5 ¼ Oz.)
H: 8 ¾" T: 1 ¾"
B: 2 ½" M: 2 ½"
2 Dz.



71086 •
Excalibur Flute (5 ¾ Oz.)
H: 7 ¾" T: 2"
B: 2 ½" M: 2 ½"
3 Dz.



P8793 •
Romeo Flute (5 ¾ Oz.)
H: 7 ¾" T: 2"
B: 2 ¾" M: 2 ½"
1 Dz.



N5082* •
V. Juliette Flute (7 ¾ Oz.)
H: 8 ¾" T: 1 ¾"
B: 2 ¾" M: 2 ¾"
2 Dz.

NEW



X0633 •
Serena Flute (7 Oz.)
H: 9 ¾" T: 1 ¾"
B: 3" M: 2 ½"
1 Dz.



V3874
Coupe Cocktail (5 ½ Oz.)
H: 4 ¾" T: 3 ¾"
B: 2 ¾" M: 3 ½"
4 Dz.



L0371 •
Excalibur Coupe Cocktail (8 Oz.)
H: 5 ¾" T: 4 ¾"
B: 3" M: 4 ¾"
2 Dz.



ARMORIM
HIGH RIM RESISTANCE



SPIRITS



Experience the World of Spirits

From colorful drinks to on the rocks, selecting the right glass for your spirit, cocktail, non-alcoholic or island drink is very important.



SHOTS

Ideal for small servings of various spirits. Shot glasses feature a thick base and a narrow opening, allowing for easy handling and controlled pouring.



WHISKEY

A staple versatile glass with sleek and simple designs made for complex cocktails or a spirit straight-up.

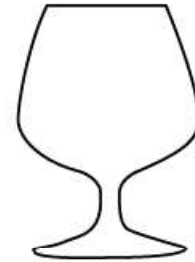

DIGESTIF

Digestifs are sipped slowly after a meal. The tulip shaped glasses aids in boosting aromas, allowing the drinker to savor the complex flavors.

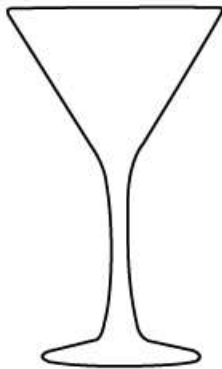

MARTINI

The iconic angled bowl showcases the visual appeal of the cocktail and enhances the aroma, while the stem prevents the hand from warming the chilled martini.

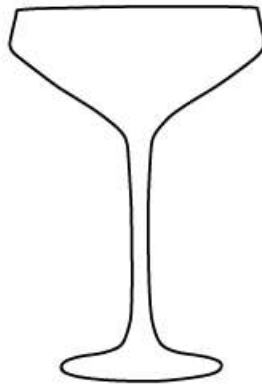

COUPE

The coupe is a vintage classic that has a shallow bowl that boosts aromas and allows maximum surface area for garnishes for a variety of cocktails.

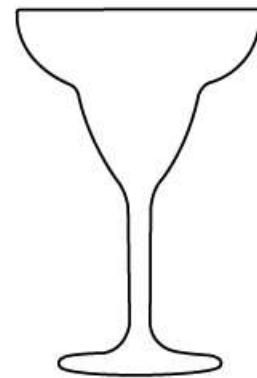

OCCASION

Occasion glasses offer a visual appeal and experience from classic margaritas to island drinks. A wide variety of shapes and cocktail specific shapes.

Coupes



FP303 •
Zephyr Specialty Cocktail
(7 1/2 Oz.)
H: 6 1/2" T: 4 3/8"
B: 3 1/8" M: 4 3/8"
2 Dz.



Q3702
Nick and Nora Cocktail (5 1/4 Oz.)
H: 5 3/8" T: 2 3/4"
B: 2 3/8" M: 2 3/4"
2 Dz.



Q7785*
Coupe Cocktail (7 Oz.)
H: 6" T: 3 1/8"
B: 2 3/4" M: 3 1/8"
2 Dz.



L3678
Sublym Coupe Cocktail (8 Oz.)
H: 7 1/8" T: 4 1/2"
B: 3" M: 4 1/2"
2 Dz.



L5641
Sequence Coupe Cocktail (7 3/4 Oz.)
H: 5 7/8" T: 4 3/8"
B: 3" M: 4 3/8"
1 Dz.



V1171
Symétrie Coupe (8 Oz.)
H: 7 1/8" T: 4 1/2"
B: 3" M: 4 1/2"
2 Dz.



N6815
Cabernet Champagne
Coupe (10 Oz.)
H: 6 3/4" T: 4 3/8"
B: 2 7/8" M: 4 3/8"
1 Dz.





V3874
Coupe Cocktail (5 ½ Oz.)
H: 4 ¾" T: 3 ¾"
B: 2 ¾" M: 3 ½"
4 Dz.



CA030
Chris Adams Coupe Cocktail (6 Oz.)
H: 5 ¾" T: 3 ½"
B: 2 ¾" M: 3 ½"
2 Dz.



CA504
Chris Adams Coupe Cocktail (6 Oz.)
H: 5 ¾" T: 3 ½"
B: 2 ¾" M: 3 ½"
2 Dz.



CA031
Chris Adams Coupe Cocktail (6 Oz.)
H: 5 ¾" T: 3 ½"
B: 2 ¾" M: 3 ½"
2 Dz.



V2761 •
Romeo Cocktail (8 Oz.)
H: 5 7/8" T: 4 1/8"
B: 3" M: 4 1/8"
1 Dz.



P8796
Broadway Coupe Cocktail (8 Oz.)
H: 5 ½" T: 4 ½"
B: 3" M: 4 ½"
1 Dz.



L0371 •
Excalibur Coupe Cocktail (8 Oz.)
H: 5 ¾" T: 4 ¾"
B: 3" M: 4 ¾"
2 Dz.



ARMORIM
HIGH RIM RESISTANCE



Martini



Shown Cabernet Cocktail (10 Oz.)



P3882
Cabernet Cocktail (7 ½ Oz.)
H: 6 ¾" T: 4 ½"
B: 3" M: 4 ½"
1 Dz.



N6831
Cabernet Cocktail (10 Oz.)
H: 7 ½" T: 4 ¾"
B: 3" M: 4 ¾"
1 Dz.





V2760 •
Romeo Cocktail (5 ½ Oz.)
H: 5 ½" T: 2 ¾"
B: 2 ¾" M: 2 ¾"
1 Dz.



V4025 •
Romeo Martini (5 Oz.)
H: 5 ½" T: 2 ¾"
B: 2 ¾" M: 2 ¾"
1 Dz.



Q1325
Monti Martini (7 Oz.)
H: 6 ½" T: 4 ½"
B: 3" M: 4 ½"
1 Dz.



P8795
Broadway Cocktail (7 Oz.)
H: 6 ½" T: 4 ½"
B: 3" M: 4 ½"
1 Dz.



D2024 ••
Excalibur Cocktail (7 ½ Oz.)
H: 6 ¾" T: 4 ½"
B: 3" M: 4 ½"
1 Dz.



00213 ••
Excalibur Cocktail (10 Oz.)
H: 7 ¾" T: 4 ¾"
B: 3" M: 4 ¾"
1 Dz.

09232 •
Excalibur Cocktail (7 ½ Oz.)
H: 6 ¾" T: 4 ½"
B: 3" M: 4 ½"
1 Dz.

79320 •
Excalibur Cocktail (10 Oz.)
H: 7 ¾" T: 4 ¾"
B: 3" M: 4 ¾"
1 Dz.



N6216
Kyoto (5 Oz.)
H: 3" T: 3 ¾"
B: 2 ¾" M: 3 ¾"
16 Pcs.



Q7932
Broadway Vintage Cocktail (8 ¼ Oz.)
H: 7 ½" T: 3 ½"
B: 3" M: 3 ½"
1 Dz.



E6132 •
Outdoor Perfect Cocktail (10 Oz.)
H: 7 ¾" T: 4 ¾"
B: 3 ¼" M: 4 ¾"
2 Dz.



ARMORIM
HIGH RIM RESISTANCE





Occasion



71093 ●
Excalibur Petite Cuvee (13 Oz.)
H: 7" T: 2 3/4"
B: 3" M: 3 5/8"
2 Dz.



71081 ●
Excalibur Grand Cuvee (13 Oz.)
H: 8 1/2" T: 2 3/4"
B: 3" M: 3 5/8"
2 Dz.



P8821
Broadway Gin Cocktail (19 1/2 Oz.)
H: 7 1/2" T: 4 1/4"
B: 3 1/4" M: 4 1/4"
1 Dz.



N2760
G&T Cocktail (24 Oz.)
H: 7 3/4" T: 3 3/4"
B: 3 1/4" M: 4 1/2"
1 Dz.





Shown Romeo Margarita (12 Oz.)



V4222 •
Romeo Margarita (12 Oz.)
H: 6 1/8" T: 4 3/8"
B: 3" M: 4 5/8"
1 Dz.



E6127 •
Outdoor Perfect Margarita (12 Oz.)
H: 6 3/8" T: 4 3/8"
B: 3 1/4" M: 4 3/4"
2 Dz.



C2172
Hurricane (15 Oz.)
H: 8 1/4" T: 3 1/8"
B: 3" M: 3 1/8"
2 Dz.



E6128 •
Outdoor Perfect Hurricane (14 3/4 Oz.)
H: 9 1/8" T: 2 3/8"
B: 3" M: 2 3/8"
3 Dz.



ARMORIM +
HIGH RIM RESISTANCE



Moscow Mules

Striking metallic presentations to serve your classic Moscow Mules, Ginger Beers and Beverages. This vessel can also be used for your appetizer needs like french fries, zucchini sticks, and more.



FK364
Copper Moscow Mule (16 Oz.)
H: 4" T: 3 3/8"
B: 2 1/4" M: 4 3/8"
1 Dz.



FK368
Copper Hammered Moscow Mule (16 Oz.)
H: 4" T: 3 3/8"
B: 2 1/4" M: 4 3/8"
1 Dz.



FK492
Black Moscow Mule (16 Oz.)
H: 4" T: 3 3/8"
B: 2 1/4" M: 4 3/8"
1 Dz.



FK493
Black Hammered Moscow Mule (16 Oz.)
H: 4" T: 3 3/8"
B: 2 1/4" M: 4 3/8"
1 Dz.



Shots

Shown Hot Shot (1 ¼ Oz.)



N0529
Urbane Whiskey/Shot (3 ½ Oz.)
H: 3" T: 2 ¾"
B: 1 ½" M: 2 ¾"
1 Dz.



V8248
Hot Shot (1 ¼ Oz.)
H: 2 ¾" T: 1 ¾"
B: 1 ½" M: 1 ¾"
2 Dz.



00016
Shot Glass (1 ¼ Oz.)
H: 2" T: 1 ¾"
B: 1" M: 1 ½"
2 Dz.



H5057
Shot Glass (1 ¾ Oz.)
H: 2 ¼" T: 1 ½"
B: 1 ½" M: 1 ½"
6 Dz.



N5834
Salto Cordial (2 Oz.)
H: 2 ½" T: 1 ¾"
B: 1 ¾" M: 1 ¾"
4 Dz.



V2910
Broadway Shot (2 Oz.)
H: 2 ¾" T: 1 ¾"
B: 1 ½" M: 1 ¾"
2 Dz.



G2639
Hot Shot (2 ½ Oz.)
H: 3 ¾" T: 2 ½"
B: 1 ½" M: 2 ½"
4 Dz.



19188
Square Shot Glass (2 ½ Oz.)
H: 2 ¾" T: 2 ¾"
B: 2" M: 2 ¾"
6 (1 Dz. Packs)



C3966
Tall Square Shot Glass (2 ¾ Oz.)
H: 3 ¾" T: 1 ¾"
B: 1 ¾" M: 1 ¾"
6 Dz.



Q5761
Cordial (2 ¼ Oz.)
H: 4 ½" T: 1 ½"
B: 1 ¾" M: 1 ½"
4 Dz.
Old SKU: 40375



47346
Cabernet Cordial (2 ½ Oz.)
H: 3 ½" T: 1 ½"
B: 1 ¾" M: 1 ¾"
4 Dz.

Whiskey

A curated collection of Whiskey favorites.



Shown Zephyr Rocks (10 ½ Oz.)

NEW



FP373 •
Zephyr Rocks (10 ½ Oz.)
H: 2 7/8" T: 3 1/4"
B: 3 1/4" M: 3 1/4"
2 Dz.



G3659
Cabernet Sheer Rocks (7 Oz.)
H: 2 3/4" T: 2 3/4"
B: 2 3/8" M: 2 3/4"
2 Dz.

ALSO AVAILABLE IN:
G3666 (10 ½ Oz.), **L2370** (12 ½ Oz.)



Q4353
Architecte Rocks (10 3/4 Oz.)
H: 3 7/8" T: 3 1/2"
B: 2 3/4" M: 3 1/2"
1 Dz.



Q4354
Rendez-Vous Rocks (10 3/4 Oz.)
H: 3 3/4" T: 3 1/2"
B: 3" M: 3 1/2"
1 Dz.



L5758
Sequence Rocks (10 ½ Oz.)
H: 3 1/2" T: 3"
B: 2 1/4" M: 3 3/8"
1 Dz.

ALSO AVAILABLE IN:
L5757 (8 ½ Oz.), **L5756** (13 ½ Oz.)



G3367
Lima Old Fashioned (11 3/4 Oz.)
H: 3 1/4" T: 2 7/8"
B: 2 1/8" M: 3 1/2"
2 Dz.





Shown Broadway Double Rocks (12 ½ Oz.)



P4188
Brixton Rocks (10 ½ Oz.)
H: 4 T: 3 ¼" M: 3 ¼" B: 2 ¾"
1 Dz.
ALSO AVAILABLE IN:
NEW P9067 (12 ½ Oz.)



N0524 ●●
Urbane Double Old Fashioned (12 Oz.)
H: 4 ½" T: 3 ¾"
B: 2 ¾" M: 3 ¾"
1 Dz.
ALSO AVAILABLE IN:
N0531 (9 Oz.)



D0616
Islande Old Fashioned (7 Oz.)
H: 3 ¼" T: 2 ¾"
B: 2 ⅝" M: 2 ¾"
4 Dz.
ALSO AVAILABLE IN:
12652 (8 ½ Oz.), **V3469** (10 Oz.),
V3476 (12 ¾ Oz.)



FP321
Broadway Double Rocks (12 ½ Oz.)
H: 3 ¾" T: 3 ⅝"
M: 3 ⅝" B: 2 ⅞"
2 Dz.
ALSO AVAILABLE IN:
NEW FP320 (7 ½ Oz.), **L7254** (10 ½ Oz.)



P8500 ●
Precision Double Old Fashioned (10 ½ Oz.)
H: 4" T: 3 ¼"
B: 3" M: 3 ¼"
1 Dz.
ALSO AVAILABLE IN:
P8495 (14 Oz.)



N5995 ●
V. Juliette Double Old Fashioned (11 ¾ Oz.)
H: 3 ¼" T: 3"
B: 2 ¼" M: 3 ¾"
2 Dz.



ARMORIM
HIGH RIM RESISTANCE

ARMORIM
HIGH RIM RESISTANCE





V5794
Cabernet Cordial (2 ¼ Oz.)
H: 5 ¼" T: 1 ¾"
B: 2" M: 1 ¾"
2 Dz.
Old SKU: E5358



14798
Cabernet Port (4 Oz.)
H: 5 ¾" T: 1 ¾"
B: 2" M: 2 ½"
2 Dz.



N8212
Cordial (4 Oz.)
H: 7 ¾" T: 1 ½"
B: 2 ¾" M: 2"
2 Dz.



N6374
Spirit Taster (6 Oz.)
H: 5" T: 1 ¾"
B: 2 ½" M: 3"
2 Dz.



N8172
Brandy (24 Oz.)
H: 6 ¾" T: 2 ¾"
B: 3 ¼" M: 4 ½"
2 Dz.



U1032
Open Up Warm Tumbler (10 Oz.)
H: 3 ¾" T: 2 ¾"
B: 1 ¾" M: 3 ¾"
2 Dz.



Shown Open Up Warm Tumbler (10 Oz.)



42258
 Viticole (4 ¼ Oz.)
 H: 5 ½" T: 1 ¾"
 B: 2" M: 2 ½"
 2 Dz.



L6119
 Kenzie Taster (5 ¾ Oz.)
 H: 4" T: 2"
 B: 2 ½" M: 2 ¾"
 3 Dz.



71079 •
 Excalibur Brandy (12 Oz.)
 H: 5 ¼" T: 2"
 B: 2 ½" M: 2 ¾"
 2 Dz.



62664
 Cabernet Brandy (13 ¾ Oz.)
 H: 5 ½" T: 2 ½"
 B: 3 ¼" M: 3 ¾"
 24 Pcs.





BEER

The Right Glass For A Crafted Experience

Selecting the right craft beer glass is essential for unlocking the full potential of your drink, as different shapes and styles are designed to highlight specific aromas, flavors, and carbonation levels, elevating the overall tasting experience.

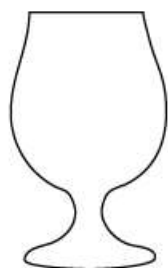

STEMWARE

Lambics
Saisons
Upscale Ales
Lagers

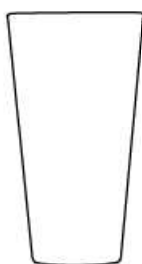

GENERAL

Macro Brews
All Purpose



PUB GLASSES

IPA
Pale Ales
Brown Ales
Stouts

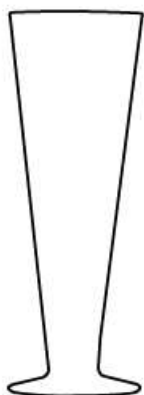

PILSNER

Pilsners
Pale Lagers



MUGS

Festbiers
Dark lagers
Lagers

Stemware

Tulip shaped stemware elevates the customer experience for high price point occasion beers.

Chef&Sommelier



P0089
Sequence Belgian Beer
(12 ½ Oz.)
H: 5 7/8" T: 2 ½"
B: 2 7/8" M: 3 ¼"
2 Dz.



N5368
Sublym Beer/All Purpose
(13 Oz.)
H: 7 ¼" T: 2 ¼"
B: 3" M: 3 ½"
2 Dz.



G3573
Cabernet Beer/All Purpose
(13 ½ Oz.)
H: 6 9/16" T: 2 7/8"
B: 3 1/16" M: 3 3/16"
2 Dz.



G3570
Cabernet Beer/Iced Tea
(16 Oz.)
H: 7 7/16" T: 2 3/8"
B: 3 1/16" M: 3 3/16"
2 Dz.



N9711
Sequence Beer/Iced Tea
(16 Oz.)
H: 7 ¼" T: 2 ¾"
B: 3" M: 3 ½"
2 Dz.



Shown Beer/Iced Tea (16 Oz.)





FL337*
Belgian Beer (13 Oz.)
H: 5 1/2" T: 2 3/8"
B: 3" M: 3 1/8"
2 Dz.



P8782 •
Romeo All Purpose/ Beer (16 Oz.)
H: 7" T: 2 7/8"
B: 3" M: 3 1/4"
1 Dz.



C3544
Schooner (18 Oz.)
H: 7 1/4" T: 4 7/16"
B: 3 1/2" M: 4 3/4"
1 Dz.



07134
Cervoise (10 1/2 Oz.)
H: 6 1/2" T: 2 3/8"
B: 2 5/16" M: 2 7/8"
2 Dz.



V3872
Cervoise (12 1/2 Oz.)
H: 7" T: 2 9/16"
B: 2 3/4" M: 3"
2 Dz.



V3873
Cervoise (16 1/2 Oz.)
H: 7 1/2" T: 2 3/4"
B: 2 15/16" M: 3 1/4"
2 Dz.

General



J8821
Party Mixing Glass (16 Oz.)
H: 4 7/8" T: 3 3/4"
B: 2 1/2" M: 3 3/4"
2 Dz.



E5458
Can Cooler (16 Oz.)
H: 5 1/4" T: 2 3/8"
B: 2 1/2" M: 3"
3 Dz.



L4865
Tall Can Cooler (16 Oz.)
H: 6 1/2" T: 2 1/4"
B: 2 1/2" M: 2 5/8"
2 Dz.



J4089 ●
Mixing Glass (14 Oz.)
H: 5 3/4" T: 3 1/2"
B: 2 3/8" M: 3 1/2"
2 Dz.



H3856 ● ●
Stack Up Beverage (14 Oz.)
H: 5 1/16" T: 3 1/4"
B: 2 1/4" M: 3 1/4"
1 Dz.



H3089 ● ●
Stack Up Cooler (16 Oz.)
H: 5 3/4" T: 3 7/16"
B: 2 3/8" M: 3 7/16"
1 Dz.



43100
Mixing Glass
Heavy Sham (14 Oz.)
H: 5 3/4" T: 3 1/2"
B: 2 3/8" M: 3 7/16"
2 Dz.



J4106 ●
Mixing Glass (16 Oz.)
H: 5 3/4" T: 3 1/2"
B: 2 3/8" M: 3 1/2"
2 Dz.



19343 ●
Mixing Glass (16 Oz.)
H: 5 3/4" T: 3 1/2"
B: 2 3/8" M: 3 1/2"
2 Dz.



G3960
Mixing Glass (16 Oz.)
H: 5 3/4" T: 3 1/2"
B: 2 3/8" M: 3 1/2"
2 Dz.



44273
Mixing Glass
Heavy Sham (18 Oz.)
H: 6 3/4" T: 3 1/16"
B: 2 3/8" M: 3 1/16"
2 Dz.



22032 ●
Mixing Glass (20 1/2 Oz.)
H: 6 3/4" T: 3 3/8"
B: 2 3/8" M: 3 5/8"
2 Dz.



L8970 ●
Mixing Glass (22 Oz.)
H: 7" T: 3 5/8"
B: 2 1/2" M: 3 5/8"
2 Dz.





Shown Nonic Tumbler (10 Oz.)

Pub Glasses

ARCOROC

Best for IPAs, Pale Ales, Brown Ales, and Stouts. Features a wide mouth to support the frothy head of traditional ales.



V9346 ●●
Nonic Tumbler (10 Oz.)
H: 4 1/2" T: 2 1/16"
B: 2 1/16" M: 2 7/8"
2 Dz.



E8792 ●●●
Nonic Tumbler (16 Oz.)
H: 5 3/8" T: 3 1/8"
B: 2 1/2" M: 3 3/16"
4 Dz.



V3471 ●●
Nonic Tumbler (20 Oz.)
H: 5 1/16" T: 3 3/8"
B: 2 5/8" M: 3 7/16"
2 Dz.

Old SKU: 43716



V7445
Willi Tumbler (13 1/2 Oz.)
H: 5 7/8" T: 2 3/8"
B: 2" M: 2 5/8"
1 Dz.



C5872
Willi Tumbler (16 Oz.)
H: 6 3/8" T: 2 1/16"
B: 2 1/4" M: 3 1/16"
1 Dz.



J0825 ●●
Tulip Tumbler (16 Oz.)
H: 5 3/4" T: 3 1/16"
B: 2 1/2" M: 3 5/16"
2 Dz.



52643 ●●●
Tulip Tumbler (16 Oz.)
H: 5 3/4" T: 3 1/16"
B: 2 1/2" M: 3 5/16"
2 Dz.



P3008 ●●
Tulip Tumbler (20 Oz.)
H: 6 3/8" T: 3 1/16"
B: 2 5/8" M: 3 5/16"
2 Dz.





Pilsners

The Pilsner glass showcases the beer's color, clarity and carbonation. The conical shape helps maintain the beer's head and allows aromas to reach your nose.



N2644
Classic Pilsner (14 Oz.)
H: 9" T: 3 1/8"
B: 3 1/4" M: 3 1/4"
1 Dz.



D0129
Occasion Pilsner (15 Oz.)
H: 8 3/8" T: 2 5/8"
B: 2 7/8" M: 2 7/8"
2 Dz.



04900
Martiques (16 Oz.)
H: 8 3/8" T: 3 1/4"
B: 2 1/2" M: 3 1/4"
2 Dz.



25263
Linz (13 ½ Oz.)
H: 8 ½" T: 2 ¾"
B: 2 1/16" M: 2 ¾"
2 Dz.



H9211
Linz (18 ½ Oz.)
H: 7 ½" T: 3 ½"
B: 3 ¼" M: 3 ¼"
2 Dz.



25275
Linz (23 Oz.)
H: 8 ½" T: 3 5/16"
B: 3 ¼" M: 3 5/16"
2 Dz.



21053
Grand Pilsner (16 Oz.)
H: 8 ¾" T: 2 7/8"
B: 2 ½" M: 2 7/8"
3 Dz.



19416
Grand Pilsner (20 Oz.)
H: 8 7/16" T: 3 ¼"
B: 2 ¾" M: 3 ¼"
2 Dz.



19415
Grand Pilsner (23 Oz.)
H: 9" T: 3 ¼"
B: 2 ¾" M: 3 ¼"
2 Dz.



36229
Pub Pilsner (23 Oz.)
H: 9" T: 3 ½"
B: 2 7/8" M: 3 3/8"
2 Dz.



E6141 •
Outdoor Perfect Pilsner (23 Oz.)
H: 10" T: 3 ¼"
B: 2 7/8" M: 3 ¼"
3 Dz.



Mugs



C0790
Dayton Mug (22 Oz.)
H: 8 5/8" T: 3"
B: 3 3/8" M: 3 3/8"
1 Dz.



53404
Sport Mug (25 Oz.)
H: 6 5/8" T: 3 3/8"
B: 4" M: 6"
1 Dz.



C1643
Mug (10 Oz.)
H: 5 7/8" T: 2 7/8"
B: 3 1/4" M: 4 7/8"
1 Dz.

Samplers



Shown Kenzie Taster (5 3/4 Oz.), Hollow Beer Paddle



D2443
Bell Taster (7 1/4 Oz.)
H: 4" T: 2 1/2"
B: 1 7/8" M: 2 5/8"
6 Dz.



L6119
Kenzie Taster (5 3/4 Oz.)
H: 4" T: 2"
B: 2 1/8" M: 2 5/8"
3 Dz.



FK856*
Hollow Beer Paddle
16" x 3 1/4" Hole Dimension: 2"
1 Dz.

*Hand Wash ONLY

Glassware Recommendations:
D2443, L6119, N0529, J4238, J4094

Room Tumblers

With a simple and functional design, the in-room tumbler is suitable for a variety of beverages, including water, juice, or other non-alcoholic drinks.



Shown Broadway Rocks (10 1/2 Oz.)



L7254
Broadway Rocks (10 1/2 Oz.)
H: 3 1/2" T: 3 3/8"
B: 3" M: 3 3/8"
2 Dz.

ALSO AVAILABLE IN:
NEW FP320 (7 1/2 Oz.)



43746
Room Tumbler (8 Oz.)
H: 3 3/8" T: 2 3/4"
B: 2 5/8" M: 2 3/4"
6 Dz.



29811
Room Tumbler (8 3/4 Oz.)
H: 3 3/8" T: 3"
B: 2 3/4" M: 3"
3 Dz.



E1908 •
Petale Hi Ball (8 3/4 Oz.)
H: 4 1/8" T: 3"
B: 2" M: 3"
4 Dz.



76495
Sterling Rocks (9 3/4 Oz.)
H: 3 3/8" T: 3 3/8"
B: 3 1/8" M: 3 3/8"
3 Dz.



43745
Room Tumbler (11 Oz.)
H: 3 1/2" T: 3 1/8"
B: 3" M: 3 1/8"
3 Dz.

BOTTOM OF GLASS



V8953
Imperator Old Fashioned (10 1/4 Oz.)
H: 3 3/8" T: 3 1/4"
B: 2 1/2" M: 3 1/4"
2 Dz.



V8954
Elysees Old Fashioned (10 1/2 Oz.)
H: 3 3/8" T: 3 1/8"
B: 2 3/4" M: 3 1/8"
2 Dz.



V8956
Quadrille Old Fashioned (10 1/4 Oz.)
H: 3 1/2" T: 3 1/4"
B: 2 3/8" M: 3 1/4"
2 Dz.



FP683
Luxe Rocks (10 1/2 Oz.)
H: 3 3/8" T: 3 1/4"
B: 3 1/8" M: 3 1/4"
2 Dz.



Decanters & Carafes

A decanter is an elegant vessel that exposes the wine to oxygen, allowing it to breathe and develop its flavors and aromas before being served.



D6653
Open Up Decanter (47 ¼ Oz.)
H: 12 ¾" M: 5 ¾"
2 Pcs.



R0020
Opening Decanter (30 ¼ Oz.)
H: 9 ¾" M: 8 ¾"
2 Pcs.



V9689
Millesime Carafe,
Magnum (67 ½ Oz. - 2 L)
H: 9 ½" T: 2 ¾"
B: 4 ¼" M: 8 ¼"
2 Pcs.



FL470
Carafe (10 Oz.)
H: 4 3/4" T: 2 5/8"
B: 3" M: 3"
2 Dz.
APPROXIMATE POUR LINE



D1C08365
Wave Carafe (8 1/4 Oz.)
(with blue wave pour line)
H: 5 1/4" T: 2 1/4"
B: 2 1/4" M: 3 1/8"
1 Dz.
APPROXIMATE POUR LINE

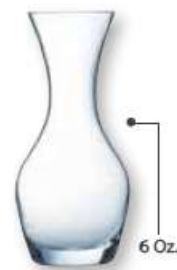

FE644*
By the Glass Carafe
H: 6" T: 2"
B: 1 7/8" M: 2 3/4"
2 Dz.

*DUE TO THE NATURE OF THE MOUTHBLOWN DESIGN CAPACITIES MAY VARY UP TO 0.5 OZ.



C0198
Carafe (8 1/4 Oz. - 1/4 L)
H: 5 1/4" T: 2 1/4"
B: 2 1/4" M: 3 1/8"
1 Dz.



33040
Carafe (17 Oz. - 1/2 L)
H: 6 1/2" T: 2 3/8"
B: 2 3/4" M: 3 7/8"
1 Dz.



10291
Carafe (33 3/4 Oz. - 1L)
H: 8" T: 3"
B: 3 3/8" M: 4 5/8"
6 Pcs.



53673
Carafe (17 Oz. - 1/2 L)
H: 7 3/4" T: 1 5/8"
B: 3 1/8" M: 3 1/8"
1 Dz.



53675
Carafe (33 3/4 Oz. - 1L)
H: 10" T: 2 1/8"
B: 3 3/4" M: 3 3/4"
6 Pcs.



FP331
Bystro Grand Carafe (33 3/4 Oz. - 1L)
H: 10 3/4" T: 3 1/4"
B: 3 1/2" M: 3 5/8"
1 Dz.



N4080
Carafe (33 3/4 Oz. - 1L)
H: 9 3/4" T: 2 3/4"
B: 3 1/2" M: 3 1/2"
6 Pcs.

Fluid Carafes

Capacity measurements are to the neck.



L4212
Fluid Carafe (8 1/4 Oz.)
H: 5 1/4" M: 2 3/4"
1 Dz.



L3963
Fluid Carafe (16 3/4 Oz.)
H: 7 1/2" M: 3 1/2"
6 Pcs.



Q4033*
Fluid Carafe Frost Blue (25 1/4 Oz.)
H: 8 1/4" M: 3 3/8"
6 Pcs.



Q4025*
Fluid Carafe Frost Green (25 1/4 Oz.)
H: 8 1/4" M: 3 3/8"
6 Pcs.



Q4026*
Fluid Carafe Frost (25 1/4 Oz.)
H: 8 1/4" M: 3 3/8"
6 Pcs.



L6247
Fluid Carafe (25 1/4 Oz.)
H: 8 1/4" M: 3 3/8"
6 Pcs.



L3965
Fluid Carafe (33 3/4 Oz.)
H: 10 3/8" M: 4 1/8"
6 Pcs.



L4257
Black Stopper
H: 1 1/2" M: 2 3/4"
2 Dz.
Fits: L3965, L6247, Q4033, Q4025, Q4026

Pitchers



E7255
Pitcher with Pour Lip (34 Oz.)
H: 8" T: 3 7/8"
B: 3 3/8" M: 5 3/4"
6 Pcs.



G3478
Pitcher with Pour Lip (16 Oz.)
H: 5 3/4" T: 3 7/8"
B: 3 3/8" M: 5"
12 Pcs.



E7254
Pitcher with Pour Lip (44 Oz.)
H: 8 1/2" T: 4"
B: 4" M: 8 3/8"
6 Pcs.



C0678
Pitcher with Pour Lip (60 Oz.)
H: 9" T: 5 3/4"
B: 4 1/2" M: 8 1/4"
6 Pcs.



E9298 •
Outdoor Perfect Pitcher
with Pour Lip (67 1/2 Oz.)
H: 10 1/4" T: 9"
B: 3 1/4" M: 9"
1 Dz.

Swing Top Bottle



FJ014
Swing Top Bottle (8 1/2 Oz.)
H: 7 7/8" T: 1 1/8"
B: 2 1/8" M: 2 1/2"
2 Dz.



FJ015
Swing Top Bottle (17 Oz.)
H: 10" T: 1 1/8"
B: 2 1/2" M: 2 3/4"
1 Dz.



FJ016
Swing Top Bottle (25 1/4 Oz.)
H: 11 1/4" T: 1 1/8"
B: 3" M: 3 1/4"
6 Pcs.



MIX

The Mix Collection, designed by world renowned mixologist, Chris Adams, was made to withstand the rigor of high volume restaurants and bars, while still focusing on the craft.



FP198
Ellis Adams Jigger
Bronze Copper
H: 3 1/4" T: 2"
B: 1 3/4" M: 2"
1 Pc.



MT051
Ellis Adams Jigger
Black Matte
H: 3 1/4" T: 2"
B: 1 3/4" M: 2"
1 Pc.



CAP32
Stainless Jigger
H: 3 1/4" T: 2"
B: 1 3/4" M: 2"
1 Pc.
*Inner Oz. Indicators



CAP51
Tall Stainless Jigger
H: 5 1/8" T: 2"
B: 1 7/8" M: 2"
1 Pc.
*Inner Oz. indicators



OL167
Bitters Bottle/
Dasher Top (5 Oz.)
H: 4 3/8" T: 1 1/16"
B: 2 3/8" M: 2 3/8"
2 Dz.



FP332
Broadway Beaker (24 Oz.)
H: 6" T: 4 3/8"
M: 4 3/8" B: 3 5/8"
6 Pcs.



FK596
Mixing Beaker (20 Oz.)
H: 6 1/4" T: 3 1/2"
B: 3 1/2" M: 3 1/2"
8 Pcs.



FP190
Bronze Copper Shaker Tin (28 Oz.)
H: 7" T: 3 5/8"
B: 2 3/8" M: 3 5/8"
1 Pc.



CAP28
Shaker Tin (28 Oz.)
H: 7" T: 3 5/8"
B: 2 3/8" M: 3 5/8"
1 Pc.



MT849
Black Matte Shaker Tin (28 Oz.)
H: 7" T: 3 5/8"
B: 2 3/8" M: 3 5/8"
1 Pc.



CAP18
Shaker Tin (18 Oz.)
H: 5 1/4" T: 3 7/16"
B: 2 3/8" M: 3 7/16"
1 Pc.



FP188
Bronze Copper Shaker Tin (20 Oz.)
H: 5 1/4" T: 3 7/16"
B: 2 3/8" M: 3 7/16"
1 Pc.



CAP20
Shaker Tin (20 Oz.)
H: 5 1/2" T: 3 1/2"
B: 2 3/8" M: 3 1/2"
1 Pc.



MT850
Black Matte Shaker Tin (20 Oz.)
H: 5 1/2" T: 3 1/2"
B: 2 3/8" M: 3 1/2"
1 Pc.



CAP05
Dual Sided Paddle
Bar Spoon
L: 15 ¾"
1 Pc.



MT011
Dual Sided Teardrop
Bar Spoon Black Matte
L: 15 ¾"
1 Pc.



FP197
Dual Sided Teardrop Bar
Spoon Bronze Copper
L: 15 ¾"
1 Pc.



CAP04
Fine Mesh Strainer
L: 8 ¾" W: 3 ½"
1 Pc.



MT004
Fine Mesh Strainer Black Matte
L: 8 ¾" W: 3 ½"
1 Pc.



FP193
Fine Mesh Strainer Bronze Copper
L: 8 ¾" W: 3 ½"
1 Pc.



HS001
Hawthorne Strainer Stainless
L: 6 ¼" W: 3 ¾"
1 Pc.



HS002
Hawthorne Strainer
Black Matte
L: 6 ¼" W: 3 ¾"
1 Pc.



FP196
Hawthorne Strainer
Bronze Copper
L: 6 ¼" W: 3 ¾"
1 Pc.



CAP02
Julep Strainer
L: 7 1/8" W: 3"
1 Pc.



MT002
Julep Strainer Black Matte
L: 7 1/8" W: 3"
1 Pc.

NEW



FP195
Julep Strainer Bronze Copper
L: 7 1/8" W: 3"
1 Pc.



CAP07
Ellis Bar Knife
L: 8 15/16"
1 Pc.



CAP01
Tweezers
L: 6 1/4"
1 Pc.



CAP09
Muddler
L: 9 1/2"
1 Pc.



OL166
Juice Bottle (16 Oz.)
H: 10 1/8" T: 1 1/8"
B: 2 3/8" M: 2 3/8"
6 Pcs.



Silicone Bands 1/2"
6 Pcs.
(Colors Sold Separately)

- RBP04** Purple
- RBB02** Blue
- RBV03** Yellow
- RBDG3** Green
- RBW06** White
- RBR09** Red
- RBB06** Black
- RBBR7** Brown





OUTDOOR PERFECT

Made from fully recyclable, BPA-Free S.A.N. plastic.
Tests have shown no deterioration in the material
up to 2,000 cycles in an industrial dishwasher.
In addition, pieces feature water vents on the
bottom to allow proper drainage.

For Cold Beverages ONLY



Shown Flute (5 ½ Oz.), Margarita (12 Oz.), Double Old Fashioned (14 ¾ Oz.)



E6125
Flute (5 ½ Oz.)
H: 8 ½" T: 2"
B: 2 ¾" M: 2 ¼"
3 Dz.



E6131
Wine (10 Oz.)
H: 7 ¾" T: 2 ½"
B: 3" M: 3"
3 Dz.



FM120
Stemless Wine (15 Oz.)
H: 4 ¾" T: 2 ½"
B: 1 ¾" M: 3 ¾"
3 Dz.



E6132
Cocktail (10 Oz.)
H: 7 ¾" T: 4 ¾"
B: 3 ¼" M: 4 ¾"
2 Dz.



E6127
Margarita (12 Oz.)
H: 6 ¾" T: 4 ¾"
B: 3 ¼" M: 4 ¾"
2 Dz.



E6128
Hurricane (14 ¾ Oz.)
H: 9 ½" T: 2 ½"
B: 3" M: 2 ¾"
3 Dz.

Outdoor Perfect



E6134
Rocks (10 Oz.)
H: 4 1/2" T: 3 1/4"
B: 2" M: 3 1/4"
3 Dz.



FN090*
Rocks (10 1/2 Oz.)
H: 3 3/8" T: 3 3/8"
B: 2 1/2" M: 3 3/8"
3 Dz.



FN091*
Double Old Fashioned (12 Oz.)
H: 3 7/8" T: 3 3/8"
B: 2 1/8" M: 3 3/8"
3 Dz.



E6137
Double Old Fashioned (14 3/4 Oz.)
H: 4 1/2" T: 3 3/4"
B: 2 5/8" M: 3 3/4"
3 Dz.



E6136
Hi Ball (12 3/4 Oz.)
H: 6 1/4" T: 3"
B: 1 7/8" M: 3 1/4"
3 Dz.



E6138
Hi Ball (16 Oz.)
H: 7" T: 3 1/8"
B: 2 1/8" M: 3 1/8"
3 Dz.



FN092*
Beverage (14 Oz.)
H: 5 1/8" T: 3 1/4"
B: 2 1/4" M: 3 1/4"
3 Dz.



FN093*
Cooler (16 Oz.)
H: 5 3/4" T: 3 7/8"
B: 2 3/8" M: 3 7/8"
3 Dz.



FM077
Cooler (19 3/4 Oz.)
H: 6 3/8" T: 3 3/4"
B: 2 3/8" M: 3 3/4"
3 Dz.



E6133
Rocks (3 Oz.)
H: 3 3/8" T: 2 1/8"
B: 1 1/8" M: 2"
3 Dz.



E6141
Pilsner (23 Oz.)
H: 10" T: 3 1/4"
B: 2 7/8" M: 3 1/4"
3 Dz.







Dinnerware



Shown Harvest Collection, Evo Origins Collection



Fully Glazed Foot

Fully vitrified high alumina ceramic bodies creates a "closed" structure and the result is a very strong and durable product.

Organic White	178
Evo Origins	180
Harvest	182
Harvest Mediterranean Moresque NEW	186
Harvest Norse White NEW	188
The Maker's Collection: Finca Limestone	190
The Maker's Collection: Porto Blue NEW	192
Eternity Plus	194



Made In England – Using the Dudson Finest Vitrified ceramic body.



Individuality Through Print – Printing creates individuality within each piece, as the light and dark color tones vary. Reactive prints create an individual texture and colors.



Handcrafted Collection – Each piece is individually glazed by hand leaving an original 'maker's mark', on the reverse, highlighting the hand crafted nature.



Fully Glazed Foot – Pin firing. Fully glazed foot prevents scratching and cross contamination when product is stacked.



Stackability – Product design specifically made for safe stacking.



Organic White

A collection of exclusive shapes. Organic White designs feature a subtle irregular edge and hand-thrown embossment. Manufactured in Dudson's Finest Vitrified body, the collection has the industrial toughness to stand up to every day use in a professional kitchen.





FN879
Coupe Plate 6 3/8"
1 Dz.



FN878
Coupe Plate 9"
1 Dz.



FN877
Coupe Plate 10 3/4"
1 Dz.



FN876
Coupe Plate 11 5/8"
1 Dz.



FN899
Flat Plate 12 1/2"
6 Pcs.



FN880
Coupe Bowl (10 1/2 Oz.)
6"
1 Dz.



FN898
Coupe Bowl (15 1/2 Oz.)
8 1/8"
1 Dz.



FN897
Coupe Bowl (28 Oz.)
9 3/4"
1 Dz.



FN884
Coupe Bowl (47 1/2 Oz.)
11"
1 Dz.



FN924
Coupe Wobbly Bowl (52 7/8 Oz.)
11 5/8"
6 Pcs.



FN883
Deep Bowl (16 1/2 Oz.)
6 7/8" x 5 3/4"
6 Pcs.



FN923
Deep Bowl (18 Oz.)
7 7/8" x 6 3/8"
6 Pcs.



FN882
Rectangular Tray
11 1/4" x 7 3/4"
6 Pcs.



FN922
Rectangular Tray
13 1/2" x 9 1/8"
6 Pcs.



FN881
Coupe Rectangular Tray
10 5/8" x 6 1/4"
1 Dz.



FN885
Coupe Rectangular Tray
13 3/4" x 6 1/4"
6 Pcs.

Evo Origins

Evo Origins has the look of real stone. Its textured semi matte finish will add a new layer of plating possibilities.

Mix it with Evo Pearl, Jet or Granite for a striking look.



Natural Grey

Black



Coupe Plate 6 1/2" ★
1 Dz.

EO165 Natural Grey
EB165 Black



Coupe Plate 8 3/8" ★
1 Dz.

EO217 Natural Grey
EB217 Black



Coupe Plate 10 1/4" ★
1 Dz.

EO260 Natural Grey
EB260 Black



Coupe Plate 11 1/4" ★
1 Dz.

EO288 Natural Grey
EB288 Black



Coupe Bowl 7 1/4" (15 Oz.) ★
1 Dz.

EO182 Natural Grey
EB182 Black



Coupe Bowl 9 3/8" (40 Oz.) ★
1 Dz.

EO248 Natural Grey
EB248 Black



Deep Coupe Plate 10" ★
1 Dz.

EO255 Natural Grey
EB255 Black



Deep Coupe Plate 11" ★
1 Dz.

EO281 Natural Grey
EB281 Black



Chefs' Oblong Plate
11 3/4" x 6"
1 Dz.

EO298 Natural Grey
EB298 Black



Chefs' Oblong Plate
13 7/8" x 7 3/8"
6 Pcs.

EO355 Natural Grey

Harvest

A handcrafted collection; each piece is individually glazed and features a hand finished sponge rim. Made in England and designed with industrial toughness.

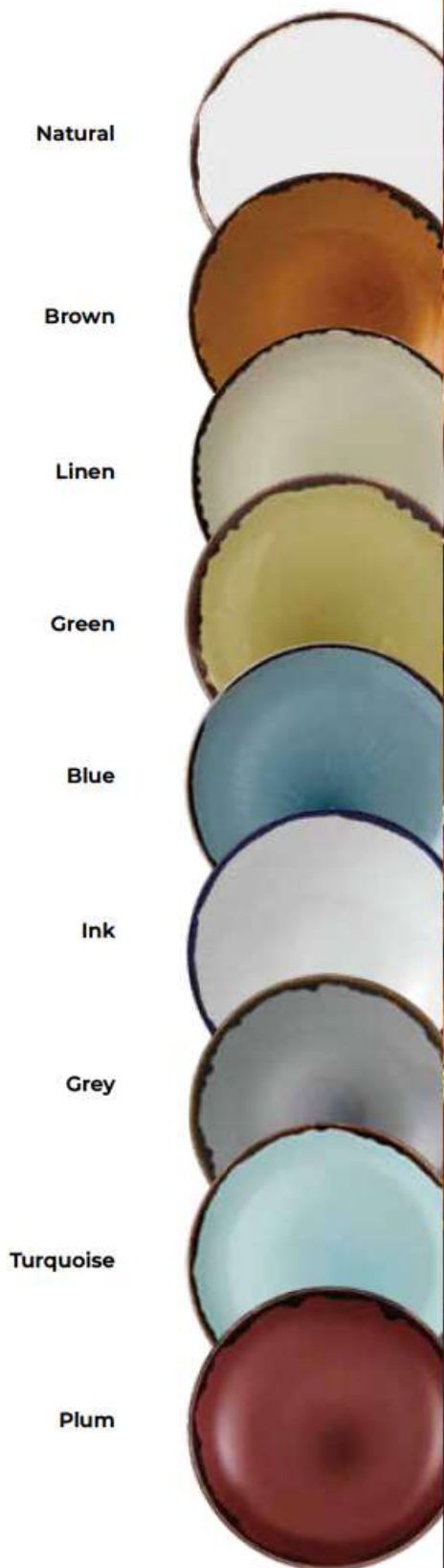



Coupe Plate 6 1/2" ★
1 Dz.

HN165 Natural
HB165 Brown
HL165 Linen
HG165 Green
HBL16 Blue
HI650 Ink
HG650 Grey
FN932 Turquoise
FP088 Plum



Coupe Plate 8 3/4" ★
1 Dz.

HN217 Natural
HB217 Brown
HL217 Linen
HG217 Green
HBL21 Blue
HI867 Ink
HG867 Grey
FN935 Turquoise
FP087 Plum



Coupe Plate 10 1/4" ★
1 Dz.

HN260 Natural
HB260 Brown
HL260 Linen
HG260 Green
HBL26 Blue
HI102 Ink
HG102 Grey
FN930 Turquoise
FP086 Plum



Coupe Plate 11 1/4" ★
1 Dz.

HN288 Natural
HB288 Brown
HL288 Linen
HG288 Green
HBL28 Blue
HI111 Ink
HG112 Grey
FN931 Turquoise
FP085 Plum



Flat Plate 12 1/2"
6 Pcs.

HN317 Natural



Coupe Plate 12 3/4" ★
6 Pcs.

HG324 Green
HB324 Blue



Deep Coupe Plate 10" ★
1 Dz.

HN255 Natural
HB255 Brown
HL255 Linen
HG255 Green
HBL25 Blue
HID10 Ink
HGD10 Grey



Deep Coupe Plate 11" ★
1 Dz.

HN281 Natural
HB281 Brown
HL281 Linen
HG281 Green
HBL11 Blue
HID11 Ink
HGD11 Grey



Coupe Bowl 7 1/4" (15 Oz.) ★
1 Dz.

HN182 Natural
HB182 Brown
HL182 Linen
HG182 Green
HBL18 Blue
HI725 Ink
HG725 Grey
FN928 Turquoise
FP090 Plum



Coupe Bowl 9 3/4" (40 Oz.) ★
1 Dz.

HN248 Natural
HB248 Brown
HL248 Linen
HG248 Green
HBL24 Blue
HI975 Ink
HG975 Grey
FN929 Turquoise
FP089 Plum



Organic Bowl 11 3/8" (52 7/10 Oz.)
6 Pcs.

HN113 Natural



Trace Organic Bowl 9 7/8" (38 Oz.)
1 Dz.

HN253 Natural
HB253 Brown
HL253 Linen
HG253 Green
HBL38 Blue
HI978 Ink
HG978 Grey





Shown Walled Plate 8 1/4" Ink



Organic Coupe Bowl 8 1/8" (15 Oz.)
1 Dz.
FN941 Turquoise



Organic Coupe Bowl 9 3/4" (28 Oz.)
1 Dz.
FN942 Turquoise



Organic Coupe Bowl 11" (47 1/2 Oz.)
1 Dz.
FN940 Turquoise



Walled Plate 8 1/4"
6 Pcs.
HNW86 Natural
HB867 Blue
FP111 Ink



Walled Plate 10 1/4"
6 Pcs.
HNW10 Natural
HB102 Blue
FP112 Ink



Deep Bowl (16 1/2 Oz.)
6 7/8" x 5 3/4"
6 Pcs.
HND63 Natural
HB634 Blue



Deep Bowl (18 Oz.)
7 7/8" x 6 5/8"
6 Pcs.
HND77 Natural
HB778 Blue



Sauce Dish (3 Oz.)
3 1/4" x 1 3/4"
1 Dz.
FM740 Natural
FN827 Ink **NEW**



Sugar Bowl/Bouillon (8 Oz.) ★
3 7/8" x 2 1/2"
1 Dz.
FM741 Natural
FN828 Ink **NEW**
(Fits: FM736, HI156, FP617)



Organic Rectangular Plate
10 5/8" x 6 1/4"
1 Dz.

FN943 Turquoise
FP091 Plum



Chef's Oblong Plate
11 3/4" x 6"
1 Dz.

HN298 Natural
HB298 Brown
HL298 Linen
HG298 Green
HBL29 Blue
HIC11 Ink
HGC11 Grey



Chef's Oblong Plate
13 7/8" x 7 3/8"
6 Pcs.

HN355 Natural
HB355 Brown
HL355 Linen
HG355 Green
HBL35 Blue
HIC13 Ink
HGC13 Grey



Small Rectangular Tray
11 1/4" x 7 1/2"
6 Pcs.

HN001 Natural
HB001 Brown
HL001 Linen
HG001 Green
HBL00 Blue
HIR11 Ink
HGR11 Grey



Organic Coupe Rectangular Platter
13 5/8" x 6 1/4"
6 Pcs.

FN946 Turquoise
FP092 Plum



Large Rectangular Tray
13 1/4" x 9"
6 Pcs.

HN002 Natural
HB002 Brown
HL002 Linen
HG002 Green
HBL01 Blue
HIR13 Ink
HGR13 Grey



Beverage Pot (13 1/2 Oz.)
4 Pcs.

FM729 Natural



Jug (5 1/2 Oz.)
4 Pcs.

FM730 Natural
HI145 Ink



Espresso Cup (3 1/2 Oz.) ★
1 Dz.

FM737 Natural
FP675 Ink **NEW**
(Fits: FM738, FP618)



Espresso Saucer 4 1/2" ★
1 Dz.

FM738 Natural



Mug (12 Oz.) ★
1 Dz.

FM739 Natural
HI113 Ink



Coffee/Tea Cup (8 Oz.) ★
1 Dz.

FM733 Natural
HI227 Ink
(Fits: FM736, HI156, FP617)



Cappuccino Cup (12 Oz.) ★
1 Dz.

FM732 Natural
(Fits: FM736)



Saucer 6 1/4" ★
1 Dz.

FM736 Natural
HI156 Ink



Harvest Mediterranean Moresque NEW

A great pairing collection to Harvest, Mediterranean Moresque adds a sophisticated touch.





FP614 ★
Coupe Plate 6 ½"
1 Dz.



FP616 ★
Coupe Bowl 7 ¼" (15 Oz.)
1 Dz.



FP615 ★
Coupe Bowl 9 ¾" (40 Oz.)
1 Dz.



FP685
Rectangular Plate
10 ⅝" x 6 ¼"
1 Dz.



FP686
Rectangular Plate
13 ⅝" x 6 ¼"
6 Pcs.



FP618 ★
Espresso Saucer 4 ½"
1 Dz.
(Fits: FP675)



FP617 ★
Saucer 6 ¼"
1 Dz.
(Fits: FN828, HI227)

SAUCERS MATCH WITH HARVEST INK ITEMS:



Fits **FP675 Ink NEW: ★**
Harvest Ink Espresso Cup
(3 ½ Oz.) 1 Dz.



Fits **HI227 Ink: ★**
Coffee/Tea Cup (8 Oz.)
1 Dz.



Fits **FN828 Ink NEW: ★**
Sugar Bowl/Bouillon (8 Oz.)
1 Dz.



Harvest NEW Norse White

Harvest Norse White is a design based on the simple rusticity and functionality of Nordic craftsmanship. The minimal radial lines have the appearance of hand-carved marks and are enhanced by hand glazing to create the rustic look and feel of crafted pottery. Norse White is finished in a semi-matte glaze.





FP182 ★
Narrow Rim Plate 6"
1 Dz.



FP181 ★
Narrow Rim Plate 7"
1 Dz.



FP180 ★
Narrow Rim Plate 9"
1 Dz.



FP179 ★
Narrow Rim Plate 10"
1 Dz.



FP184 ★
Coupe Bowl (15 Oz.) 7 ¼"
1 Dz.



FP183 ★
Coupe Bowl (40 Oz.) 9 ¾"
1 Dz.



FP189
Organic Rectangular Plate
10 ⅜" x 6 ¼"
1 Dz.



FP191
Organic Rectangular Plate
13 ⅜" x 6 ¼"
6 Pcs.



FP186 ★
Coffee/Teacup (8 Oz.)
T: 3 ¾" M: 4 ¾" H: 2 ¼"
1 Dz.



FP187 ★
Cappuccino (12 Oz.)
T: 4 ¼" M: 5 ½" H: 2 ¾"
1 Dz.



FP185 ★
Saucer 6 ¼"
1 Dz.



Finca Limestone

Finca is a multi-tonal print that mimics the worn textures of rustic interiors and architectural designs. Crafted and creative, Finca is finished in a semi-matte, hand dipped glaze, enhancing the character of the collection and leaving original 'makers marks' on the reverse of each piece.

Decorated in-glaze for industrial toughness, The Maker's Collection is designed for professional use.

THE
maker's
COLLECTION



Shown Narrow Rim Plate 6", Organic Coupe Plate 9"



FN502 ★
Narrow Rim Plate 6"
1 Dz.

FN501 ★
Narrow Rim Plate 8"
1 Dz.

FN500 ★
Narrow Rim Plate 9"
1 Dz.



FN499 ★
Narrow Rim Plate 10"
1 Dz.

FN498 ★
Narrow Rim Plate 11"
1 Dz.



Organic Coupe Plate 9" ★
1 Dz.

FN494 Limestone

Organic Coupe Plate 10 3/4"
1 Dz. ★

FN493 Limestone



FN495 ★
Organic Coupe Bowl 9 3/4" (28 Oz.)
1 Dz.



FN503 ★
Narrow Rim Bowl 8 1/4" (16 Oz.)
1 Dz.



FN496
Organic Rectangular Plate
10 3/8" x 6 1/4"
1 Dz.



FN497
Organic Rectangular Plate
13 3/8" x 6 1/4"
6 Pc.



FN504 ★
Cappuccino Cup (12 Oz.)
T: 4 1/4" M: 5 1/2" H: 2 3/4"
1 Dz.



FN505 ★
Coffee/Tea Cup (8 Oz.)
T: 3 3/4" M: 4 3/4" H: 2 1/4"
1 Dz.



FN506 ★
Saucer 6 1/4"
1 Dz.
(Fits: FN504, FN505)



FN507 ★
Espresso Cup (3 1/2 Oz.)
T: 2 1/2" M: 3 3/8" H: 2 1/4"
1 Dz.



FN508 ★
Espresso Saucer 4 1/2"
1 Dz.
(Fits: FN507)

Porto Blue NEW

The Maker's Collection Porto is inspired by the historical, hand-painted tiles featured within Portuguese architecture. Distinctive and decorative, Porto resembles a mosaic design, capturing the essence of hand-crafted and artisan Portuguese azulejos.

THE
maker's
COLLECTION





FP174 ★
Coupe Plate 6 1/2"
1 Dz.



FP173 ★
Coupe Plate 8 2/3"
1 Dz.



FP172 ★
Coupe Plate 10 1/4"
1 Dz.



FP171 ★
Coupe Plate 11 1/4"
1 Dz.



FP176 ★
Coupe Bowl 7 1/4" (15 Oz.)
1 Dz.



FP175 ★
Coupe Bowl 9 3/4" (40 Oz.)
1 Dz.



FP177
Rectangular Plate
10 3/8" x 6 1/4"
1 Dz.



FP178
Rectangular Plate
13 3/8" x 6 1/4"
6 Pc.

Eternity Plus

The classic style of Eternity Plus and its long-lasting durability complements tables at the finest restaurants and hotels.





FM566
Side Plate 5 3/4"
3 Dz.

FM538
B&B Plate 6 3/8"
3 Dz.



FM536
Dessert Plate 7"
3 Dz.

FM548
Salad Plate 8"
2 Dz.

FM558
Brunch Plate 9"
1 Dz.



FM542
Lunch Plate 9 1/2"
2 Dz.

FM547
Large Dessert/Salad Plate 10"
2 Dz.

FM569
Dinner Plate 10 5/8"
1 Dz.



FM888
Buffet Plate 11"
1 Dz.

FM544
Banquet Plate 11 1/2"
1 Dz.

FM545
Service Plate 12 1/2"
1 Dz.



FM568
Coupe Plate 6 5/8"
3 Dz.

FM553
Coupe Plate 8 7/8"
1 Dz.

FM570
Coupe Plate 10 1/2"
1 Dz.



FM560
Coupe Oval Plate 9 1/2" x 8 1/4"
2 Dz.

FM554
Coupe Oval Plate 12" x 10 1/2"
1 Dz.



FM549
Pizza Coupe Plate 12 1/4"
1 Dz.



FM556
Oval Platter 8 1/2" x 6 3/4"
2 Dz.

FM551
Oval Platter 10 1/2" x 8 1/4"
2 Dz.



FM564
Oval Platter 11 1/2" x 9 1/4"
1 Dz.

FM539
Oval Platter 12 1/2" x 10 1/4"
1 Dz.



Eternity Plus *cont'd.*



FM550
Soup Plate 8 1/2" (11 Oz.)
T: 8 1/2" H: 1 1/2"
1 Dz.

FM562
Soup Plate 9 1/2" (12 Oz.)
T: 9 1/2" H: 1 1/2"
1 Dz.



FM552
Soup/Pasta Plate 11 3/8" (18 Oz.)
T: 11 3/8" H: 1 5/8"
1 Dz.



EP777
Deep Oval Bowl 6 1/2" (16 Oz.)
L: 6 1/2" W: 5" H: 2"
1 Dz.



FM557
Chefs' Bowl 8" (30 Oz.)
T: 8" H: 2 1/4"
1 Dz.

FM561
Chefs' Bowl 10 1/2" (52 Oz.)
T: 10 1/2" H: 2 1/4"
3 Pcs.



FN097 •
Soup Bowl (9 1/2 Oz.)
T: 3 3/4" H: 2 1/4"
3 Dz.



FM567 •
Continental Bowl (12 Oz.)
T: 4 5/8" H: 2 1/4"
3 Dz.



FM537
Bouillon/Sugar (7 3/4 Oz.)
T: 4" H: 2 1/4"
3 Dz. (Fits: FM903)



FM555
Fruit Dish 4 7/8" (5 3/4 Oz.)
T: 4 7/8" H: 1 1/8"
3 Dz.



FN808
Teapot With Lid (13 Oz.)
L: 7" W: 4 1/2" H: 4 3/4"
8 Pcs.



FN809
Creamer No Handle (4 1/2 Oz.)
T: 3" H: 2 3/4" M: 3"
1 Dz.



FM713
Teacup (5 ½ Oz.)
T: 3 ¼" H: 2 ¼" M: 4 ¼"
3 Dz.
(Fits: FM540)



FM541 ●
Teacup (8 Oz.)
T: 3 ½" H: 2 ¾" M: 4"
3 Dz.
(Fits: FM540)



FM563 ●
Mug (9 ½ Oz.)
T: 3 ½" H: 3 ½" M: 4 ¼"
3 Dz.
(Fits: FM540)



FM543 ●
Hudson Mug (11 ½ Oz.)
T: 3 ½" H: 3 ¾" M: 4 ½"
3 Dz.
(Fits: FM540)



FM559
Apex Mug (12 Oz.)
T: 3 ½" H: 4 ½" M: 5"
18 Pcs.
(Fits: FM540)



FM546
Kone Mug (12 Oz.)
T: 3 ¾" H: 4" M: 4 ¾"
18 Pcs.
(Fits: FM540)



FM540
Teasaucer Avalon 5 ½"
3 Dz.



FM902
Teacup (7 ½ Oz.)
T: 3 ¾" H: 2 ¼" M: 4 ¾"
3 Dz.
(Fits: FM903)



FM904
Coffee Cup (11 oz.)
T: 4 ¼" H: 2 ½" M: 5 ½"
3 Dz.
(Fits: FM903)



FM903
Teasaucer 5 ¾"
3 Dz.



FM900
AD Cup (3 ½ Oz.)
T: 2 ½" H: 2 ½" M: 3 ½"
3 Dz.
(Fits: FM901)



FM901
AD Saucer 4 ¾"
3 Dz.







BONE CHINA

Brilliant translucence developed with bone ash for maximum strength in ceramic.

Infinity	200
Infinity Coupes	202



Stackability – Product design specifically made for safe stacking.

Infinity

Beautifully translucent and lightweight, yet strong. A favorite of upscale hotels and banquets.



FN006
B&B Plate 6 3/8"
2 Dz.

FN004
Salad/Dessert Plate 8 1/4"
2 Dz.

FN003
Salad/Banquet Plate 9 5/8"
2 Dz.

FN002
Dinner Plate 11"
1 Dz.

FN001
Service Plate 11 7/8"
1 Dz.



FN008
Rim Soup/Pasta Bowl 9" (13 Oz.)
1 Dz.



FN011
Pasta Bowl 12" (20 Oz.)
1 Dz.



FN063
Oval Platter 11 ¼" x 8 ½"
1 Dz.



FN051
Bowl (7 Oz.)
D: 5" H: 1 ½"
2 Dz.



FN034 ●
Salad/Cereal Bowl (20 Oz.)
D: 5 ½" H: 2"
2 Dz.



FN030 ●
Bouillon (8 ½ Oz.)
D: 3 ½" H: 3 ½"
2 Dz.
(Fits: FN033)



FN039
Egg Cup (1 Egg)
H: 2 ¾" M: 1 ⅞"
2 Dz.



FN019
Covered Teapot (13 ½ Oz.)
T: 3 ½" M: 6 ¾" H: 4"
1 Dz.



FN022
Covered Coffee Pot (20 ¼ Oz.)
T: 3 ¾" M: 6 ½" H: 5 ½"
1 Dz.



FN017
Creamer (3 ½ Oz.)
T: 2 ¼" M: 4" H: 2 ½"
2 Dz.



FN018
Creamer (6 ¾ Oz.)
T: 2 ½" M: 4 ¼" H: 3"
1 Dz.



FN026 ●
AD Cup (3 ½ Oz.)
T: 2" M: 3 ¾" H: 2"
2 Dz.

FN031
AD Saucer 4 ½"
2 Dz.



FN038 ●
Coffee/Teacup (8 ½ Oz.)
T: 3 ½" M: 4 ½" H: 2 ½"
2 Dz.



FN028
Coffee Cup (9 Oz.)
T: 3 ½" M: 4 ½" H: 3 ¼"
2 Dz.



FN033
Double Well Saucer 6"
2 Dz.
(Fits: FN028, FN030, FN038)



Infinity Coupes

Our Infinity design takes a new turn. The same elegant and durable Bone China now comes in a rimless coupe shape for a more contemporary appeal.





FN513
Coupe B&B Plate 6 1/4"
2 Dz.



FN512
Coupe Salad/Dessert Plate 8 1/4"
2 Dz.



FN511
Coupe Salad/Banquet Plate 9 1/2"
2 Dz.



FN514
Coupe Deep Plate 10 3/4" (35 Oz.)
1 Dz.



FN510
Coupe Dinner Plate 10 3/8"
1 Dz.



FN509
Coupe Service Plate 12"
1 Dz.



FN516
Coupe Oval Platter 10 3/4" x 8"
1 Dz.







ALUMINITE

With over 100 SKUs, the same body in multiple collections.
Developed with added alumina for superior strength for professional use.

Rondo	206
Horizon	208
Athena NEW	210
Candour Azure	212
Candour Cirrus	214
Candour Coupes	216
Candour	218
Vintage	220
Universal NEW	222



Stackability – Product design specifically made for safe stacking.

Rondo

Wide rims and deep coupe plates feature soft concentric rings.





S1506
B&B/Side Plate 6 3/4"
3 Dz.

S1504
Salad/Dessert Plate 8 5/8"
3 Dz.



S1503
Brunch Plate 9 7/8"
3 Dz.

S1502
Dinner Plate 11"
2 Dz.

S1501
Service Plate 12"
1 Dz.



S1509
Coupe Deep Plate 12"
1 Dz.



S1550
Fruit/Side Dish (4 Oz.)
4 3/4"
3 Dz.



S1508
Coupe Bowl (14 Oz.) 7"
3 Dz.

S1512
Coupe Bowl (30 Oz.) 9"
3 Dz.



S1507
Rim Soup/Pasta Bowl (8 Oz.)
9 1/4"
2 Dz.



S1534
Grapefruit/Cereal Bowl
H: 2 5/8" M: 4 3/8" (17 Oz.)
3 Dz.



S1517
Small Creamer (4 1/2 Oz.)
H: 3 1/8" T: 2" M: 4 3/8"
2 Dz.



S1518
Large Creamer (8 1/2 Oz.)
H: 3 3/8" T: 2 1/2" M: 5 1/8"
1 Dz.



S1521
Teapot with Cover (20 Oz.)
6 3/4"
1 Dz.



S1530 •
Bouillon Cup (11 Oz.)
H: 2 5/8" M: 3 3/4"
2 Dz.
(Fits: S1533)



S1535 •
Coffee Mug (10 Oz.)
H: 3 1/2" T: 3 1/8" M: 4 3/8"
1 Dz.



S1538 •
Coffee/Teacup (8 Oz.)
H: 2 1/2" T: 3 1/2" M: 4 3/8"
2 Dz.

S1533
Saucer/Bouillon Saucer 6 3/4"
2 Dz.
(Fits: S1530)



S1528
Tall Coffee/Teacup (8 Oz.)
H: 3 1/4" T: 3 1/2" M: 4 3/8"
2 Dz.

S1533
Saucer/Bouillon Saucer 6 3/4"
2 Dz.
(Fits: S1530)



Horizon

Horizon features beautifully embossed rays that bring a touch of brightness to any table. Its vibrant design and lasting strength make it both elegant and practical for everyday dining.





S0606
B&B/Side Plate 6 1/2"
3 Dz.

S0604
Salad/Dessert Plate 8 1/4"
3 Dz.



S0603
Brunch Plate 9 1/4"
2 Dz.

S0602
Dinner Plate 11"
2 Dz.



S0628
Coffee/Teacup (7 Oz.)
H: 4 1/2" T: 3 1/4" M: 4 1/2"
2 Dz.

S0633
Saucer/Bouillon Saucer 6"
2 Dz.
(Fits: S0630)



S0638 •
Coffee/Teacup (8 Oz.)
H: 2 1/2" T: 3 1/4" M: 4 1/2"
2 Dz.

S0633
Saucer/Bouillon Saucer 6"
2 Dz.
(Fits: S0630)



S0630 •
Bouillon Cup/Open Sugar (9 Oz.)
H: 3 3/4" M: 3 3/4"
2 Dz.
(Fits: S0633)



S1916
Sugar Caddy
H: 2 1/8" L: 3 5/8" W: 2 3/8"
1 Dz.





Athena NEW

Athena is a collection that combines soft, elegant lines with superior strength.



FP308
B&B Plate 6 ¼"
2 Dz.



FP307
Salad/Dessert Plate 8 ½"
2 Dz.



FP306
Banquet Plate 10"
2 Dz.



FP305
Dinner Plate 11 ¼"
1 Dz.



FP309
Rim Soup (9 ½ Oz.)
9 ½"
2 Dz.



FP313
Cup (8 Oz.)
H: 2 ¾" T: 3 ⅝" M: 4 ½"
2 Dz.



FP314
Saucer 6 ½"
2 Dz.



FP312
Oval Platter
10 ¼" x 7 ¾"
1 Dz.



FP311
Oval Platter
13" x 9 ¾"
1 Dz.



FP310
Oval Platter
14 ½" x 11"
1 Dz.



Candour Azure

Create a unique color impact with blue and white pattern combinations. Complement the line as an accent piece with any pattern in the Aluminite body.





FK643
Coupe B&B Plate 6 1/2"
2 Dz.



FK640
Coupe Salad/Dessert Plate 8 1/8"
2 Dz.



FK641
Coupe Brunch Plate 9"
2 Dz.



FK639
Coupe Dinner/Banquet Plate 10 3/4"
2 Dz.



FK642
Coupe Deep Soup Plate (24 1/2 Oz.)
8 1/8"
2 Dz.



FK644
Coupe Oval Platter 10 3/8" x 7 3/8"
1 Dz.



FK645
Coupe Oval Platter 12 1/4" x 8 3/8"
1 Dz.



FK646
Coupe Oval Platter 14 1/4" x 10"
1 Dz.

Candour Cirrus

Eye-catching swept embossment designs create the perfect harmony between refined beauty and long lasting resistance for high volume operations.





FK769
B&B Plate 6 1/4"
2 Dz.



FK768
Side Plate 7 3/8"
2 Dz.



FK767
Salad Plate 8 1/2"
2 Dz.



FK766
Brunch Plate 10"
2 Dz.



FK765
Banquet Plate 10 1/2"
1 Dz.



FK764
Dinner Plate 11 1/2"
1 Dz.



FK763
Service Plate 12"
1 Dz.



FK774
Pasta Bowl (18 1/2 Oz.)
11 3/4"
1 Dz.



FK770
Soup Bowl (12 Oz.)
8 3/4"
1 Dz.



FK777 ●
Cup (9 3/4 Oz.)
H: 2 1/4" W: 3 3/4"
2 Dz.

FK775
Saucer 6 1/2"
2 Dz.



Candour Coupes

Simply Smart. With the strength of Aluminite, Candour is a go-to favorite with customers for its long lasting resistance. Now with a rimless design, elegance has never seemed so simple.





FH288
Coupe B&B Plate 6 1/2"
2 Dz.

FH286
Coupe Salad/Dessert Plate 8 1/8"
2 Dz.

FH285
Coupe Dinner/Banquet Plate 10 3/4"
2 Dz.

FM382
Coupe Plate 11 1/2"
1 Dz.



FH621
Coupe Deep Soup Plate (24 1/2 Oz.)
8 1/8"
2 Dz.



FH608
Coupe Brunch Plate 9"
2 Dz.



FH287
Coupe Bowl (20 Oz.)
6 1/8"
2 Dz.



FH289
Coupe Bowl (101 1/2 Oz./3 L)
9 1/4"
6 Pcs.



FH609
Coupe Oval Platter 10 3/8" x 7 3/8"
1 Dz.

FH610
Coupe Oval Platter 12 1/4" x 8 7/8"
1 Dz.

FH611
Coupe Oval Platter 14 1/4" x 10"
1 Dz.



FH614
Mug (10 1/2 Oz.)
H: 3 3/8" T: 3 1/8" M: 4 3/8"
2 Dz.



FH615
Mug (14 Oz.)
H: 4 1/8" T: 3 3/8" M: 4 1/2"
2 Dz.

Candour

Wide rims, flat profiles and space-saving stackability. Matches all collections in the Aluminite body.



Shown Side Plate 7 3/8"



R0806
B&B Plate 6 1/4"
2 Dz.

R0805
Side Plate 7 3/8"
2 Dz.



R0804
Salad Plate 8 1/2"
2 Dz.

R0803
Brunch Plate 10"
2 Dz.



R0802
Banquet Plate 10 1/2"
1 Dz.

R0801
Dinner Plate 11 1/2"
1 Dz.

R0811
Service Plate 12"
1 Dz.



FP359
Rim Plate 10 1/4"
1 Dz.



FM381
Pizza Plate 12 1/2"
1 Dz.



R0809
Pasta Bowl 11 3/4" (18 1/2 Oz.)
1 Dz.



R0807
Soup Plate 8 ¾" (12 Oz.)
1 Dz.



R0840 ●
Soup Bowl 3 ¾" (9 Oz.)
2 Dz.
(Fits: R0833)



R0830 ●
Soup Bowl 4 ½" (12 ½ Oz.)
2 Dz.



R0852 ●
Bowl 2 ¾" (2 ¼ Oz.)
2 Dz.



NEW **FP620** ●
Bowl 4 ⅞" (12 Oz.)
2 Dz.

R0851 ●
Bowl 4" (8 Oz.)
2 Dz.

R0850 ●
Bowl 5 ⅞" (16 ¾ Oz.)
2 Dz.



R0839 ●
Cup (9 ¾ Oz.)
H: 2 ¼" W: 3 ¾"
2 Dz.



R0835 ●
Mug (11 Oz.)
H: 3" W: 3 ½"
2 Dz.



NEW

FP619
Double Well Saucer 6 ½"
2 Dz.
(Fits: FP620, R0839, R0840, R0830)

R0833
Saucer 6 ½"
2 Dz.
(Fits: R0840, R0830)



R0817 ●
Creamer (3 ½ Oz.)
H: 2 ¾" W: 2 ½"
16 Pcs.



R0819
Teapot (15 Oz.)
H: 4 ¼" W: 3 ½"
8 Pcs.



R0882
Vase (6 ¼ Oz.)
H: 5 ½" W: 3"
16 Pcs.



Vintage

Scooped rims and deep-welled platters create timeless appeal.



R0906
B&B Plate 6 3/4"
2 Dz.

R0905
Side Plate 7 1/4"
2 Dz.

R0904
Salad Plate 8"
2 Dz.

R0903
Brunch Plate 9 3/4"
2 Dz.

R0902
Dinner Plate 10 1/2"
1 Dz.

R0901
Service Plate 12 1/4"
1 Dz.



R0907
Soup Plate (10 Oz.)
9 1/2"
1 Dz.



R0950
Square Bowl (12 ½ Oz.)
4 ½"
2 Dz.



R0908
Soup/Cereal Bowl (16 ¾ Oz.)
7"
2 Dz.



R0947
Bowl (69 Oz.)
8 ¾"
16 Pcs.



R0960
Rectangular Dish
L: 13" W: 7 ¼"
8 Pcs.



R0968
Rectangular Dish
L: 11" W: 9 ¼"
1 Dz.



R0919
Teapot (12 Oz.)
H: 4 ¼" W: 4 ½"
8 Pcs.

R0959
Rectangular Dish
L: 14 ½" W: 7 ½"
8 Pcs.



R0917
Creamer (4 Oz.)
H: 4 ½" W: 2 ½"
16 Pcs.



R0918
Jug (12 ½ Oz.)
H: 6 ¾" W: 3 ½"
8 Pcs.



R0926
Cup (3 Oz.)
H: 2" W: 2 ½"
2 Dz.



R0928
Cup (8 Oz.)
H: 2 ½" W: 3 ½"
2 Dz.



R0929
Cup (11 ¾ Oz.)
H: 2 ¾" W: 4"
2 Dz.

R0931
Saucer 4 ¾"
2 Dz.

R0932
Saucer 5 ¾"
2 Dz.

R0933
Saucer 7"
2 Dz.

Universal

NEW

A collection of accessories in the Aluminite body to complement all of the Aluminite collections.





FP361
Universal Rectangle Platter
12 ½" x 6"
1 Dz.



FP366
Rim Oval Platter
10" x 7"
1 Dz.



FP367
Rim Oval Platter
12" x 8 ⅝"
1 Dz.



FP368
Rim Oval Platter
14 ¼" x 10 ¼"
8 Pcs.



FP362
French Onion Soup (12 Oz.)
6" x 5 ¼" x 2 ¼"
2 Dz.
(Can go in a conventional oven
392°F/200°C) 2 hours



FP363
Oval Baker (11 Oz.)
6 ⅞" x 4 ¼" x 1 ¾"
1 Dz.
(Can go in a conventional oven
392°F/200°C) 2 hours



FP370
Sauce Pot (1 ½ Oz.)
H: 1 ½" D: 2"
2 Dz.



S1916
Sugar Caddy
H: 2 ⅞" L: 3 ⅞" W: 2 ⅞"
1 Dz.



FP369
Butter/Sauce Dish (2 Oz.)
4 ¼" x 3"
2 Dz.



FP364
Salt Shaker
H: 3 ½" T: 1" B: 1 ¾"
16 Pcs.



FP365
Pepper Shaker
H: 3 ½" T: 1" B: 1 ¾"
16 Pcs.



R0882
Vase (6 ¼ Oz.)
H: 5 ½" W: 3"
16 Pcs.





Vitrified Stoneware

Vitrified stoneware made from clay and fired at high temperatures combining artisanal design with industrial strength.

Geode	226
Evo	228
Evo Azure <i>NEW</i>	232
Terra <i>NEW</i>	234
Reflections <i>NEW</i>	236
Reflections Blue Band <i>NEW</i>	238
Valentina <i>NEW</i>	240
Accessories	242
Acacia Wood*	231



Stackability – Product design specifically made for safe stacking.

*Not Stoneware.

Geode

Inspired by the Greek Geode definition, the "shape of the earth" designs feature clean and simple shapes with slight handmade touches.

NEW
Charcoal



White





Plate 4" •
2 Dz.
FK788 White



B&B/Side Plate 6" •
1 Dz.
FL645 White
FP132 Charcoal



Salad/Dessert Plate 8 1/2" •
1 Dz.
FL644 White
FP134 Charcoal



Dinner Plate 10 3/4" •
1 Dz.
FL643 White
FP131 Charcoal



Bowl •
D: 4 3/4" H: 2 3/8" (12 Oz.)
2 Dz.
FK789 White
FP130 Charcoal



Bowl •
D: 6" H: 2 1/2" (24 Oz.)
1 Dz.
FL647 White



Bowl •
D: 8 1/2" H: 1 3/4" (32 Oz.)
1 Dz.
FL646 White
FP135 Charcoal



Ramekin •
D: 2 1/2" H: 1 1/4" (1 1/4 Oz.)
2 Dz.
FL648 White
FP133 Charcoal



Espresso/Sauce Cup
H: 2 3/4" T: 2 1/4" B: 1 5/8" M: 2 1/4" (4 Oz.)
2 Dz.
FK790 White

Evo

Evo has been designed with the appearance of hand-thrown pottery, and its homely charm adds a touch of warmth to any tabletop.

Granite



Jet



Pearl





Coupe Plate 6 3/8" ★
2 Dz.

EG162 Granite
EJ162 Jet
EP162 Pearl



Coupe Plate 8" ★
2 Dz.

EG205 Granite
EJ205 Jet
EP205 Pearl



Coupe Plate 9" ★
2 Dz.

EG229 Granite
EJ229 Jet
EP229 Pearl



Coupe Plate 10 3/4" ★
1 Dz.

EG273 Granite
EJ273 Jet
EP273 Pearl



Coupe Plate 11 5/8" ★
1 Dz.

EG295 Granite
EJ295 Jet
EP295 Pearl



Flat Plate 10"
1 Dz.

EG254 Granite
EJ254 Jet
EP254 Pearl



Flat Plate 12 1/2"
8 Pcs.

EV318 Granite
EJ318 Jet
EP318 Pearl



Deep Plate 9 1/2" ★
1 Dz.

EG243 Granite
EJ243 Jet
EP243 Pearl



Deep Plate 11 1/2" ★
8 Pcs.

EG292 Granite
EJ292 Jet
EP292 Pearl



Deep Oval Bowl (16 Oz.)
6 1/2" x 4 3/4"
2 Dz.

FM913 Granite
FM914 Jet
FM915 Pearl



Deep Oval Bowl (35 Oz.)
8 1/2" x 6 1/2"
2 Dz.

EG216 Granite
EJ216 Jet
EP216 Pearl



Deep Oval Bowl (38 3/4 Oz.)
10 1/2" x 7 5/8"
1 Dz.

EG267 Granite
EJ267 Jet
EP267 Pearl



Chefs' Rectangular Tray
10 5/8" x 4 3/4"
1 Dz.

EG271 Granite
EJ271 Jet
EP271 Pearl



Chefs' Rectangular Tray
14" x 6 1/2"
8 Pcs.

EG356 Granite
EJ356 Jet
EP356 Pearl

Evo cont'd.



Rice Bowl (7 Oz.) ★
4 1/8" x 2"
2 Dz.
EG105 Granite
EJ105 Jet
EP105 Pearl
(Fits: Saucer 6 3/8")



Rice Bowl (30 Oz.) ★
7" x 2 1/4"
2 Dz.
EG178 Granite
EJ178 Jet
EP178 Pearl



Dip Pot/Taster Cup (2 1/2 Oz.)
1 1/2" x 2"
4 Dz.
FM759 Granite
FM751 Jet
FM743 Pearl



Olive/Tapas Dish (5 Oz.)
4 5/8" x 1 1/4"
4 Dz.
FM764 Granite
FM756 Jet
FM748 Pearl



Olive/Tapas Dish (10 Oz.)
6 1/4" x 1 1/4"
2 Dz.
FM765 Granite
FM757 Jet
FM749 Pearl



Teapot (28 Oz.)
T: 3 1/4" M: 7 7/8" H: 5 1/4" B: 5 1/4"
6 Pcs.
FN454 Granite



Creamer (2 Oz.)
T: 2 1/2" M: 2 1/2" H: 2"
3 Dz.
FM763 Granite
FM755 Jet
FM747 Pearl



Sugar Bouillon (8 Oz.)
3 3/4" x 2 1/4"
6 Pcs.
FN455 Granite



Mug (11 1/4 Oz.)
T: 3 3/4" M: 5" H: 3 3/8"
2 Dz.
FM760 Granite
FM752 Jet
FM744 Pearl
(Fits: Saucer 6 3/8")



Café Au Lait Cup (10 Oz.)
T: 3 3/4" M: 4 7/8" H: 2 3/4"
3 Dz.
FM761 Granite
FM753 Jet
FM745 Pearl
(Fits: Saucer 6 3/8")



Tea Cup (8 Oz.)
T: 3 3/4" M: 4 7/8" H: 2 1/8"
3 Dz.
FM758 Granite
FM750 Jet
FM742 Pearl
(Fits: Saucer 6 3/8")



Saucer 6 3/8"
2 Dz.
FM762 Granite
FM754 Jet
FM746 Pearl



Acacia Wood

Wood serveware, exclusively designed to complement the dinnerware portfolio. The Acacia Wood items feature a subtle surface texture to create a rustic effect.

Double sided designs to allow for flexibility and multiple uses. Food safe and specifically designed for the hospitality industry, Dudson Wood is also sustainable and comes from a 100% renewable source.



FN283*
Acacia Wood LG Rectangle Handled Board
L: 21 ½" W: 5 ½"
4 Pcs.



FN282*
Acacia Wood MD Rectangle Handled Board
L: 18 ¼" W: 4 ¾"
4 Pcs.



FN284*
Acacia Wood Square Handled Board
L: 14 ¾" W: 10"
4 Pcs.

Pairs well with:
Dudson Evo Collection, Harvest Collection
For a full pairing guide visit: Page 372

Evo Azure NEW

The lightness of sky blue meets the strength of granite in Evo Azure to create vessels that stimulate the senses and inspire creativity.

Evo Azure was designed to complement the timeless colors of Evo Pearl, Jet and Granite.





FP444 ★
Coupe Plate 6 $\frac{3}{8}$ "
6 Pcs.



FP445 ★
Coupe Plate 8"
6 Pcs.



FP446 ★
Coupe Plate 9"
6 Pcs.



FP447 ★
Coupe Plate 10 $\frac{3}{4}$ "
6 Pcs.



FP448 ★
Coupe Plate 11 $\frac{5}{8}$ "
6 Pcs.



FP439 ★
Deep Plate 9 $\frac{1}{2}$ "
6 Pcs.



FP440 ★
Deep Plate 11 $\frac{1}{2}$ "
4 Pcs.



FP449 ★
Rice Bowl (7 Oz.)
4 $\frac{1}{8}$ "
6 Pcs.



FP450 ★
Rice Bowl (30 Oz.)
7"
6 Pcs.



FP452
Rectangular Tray
10 $\frac{3}{8}$ " x 4 $\frac{3}{4}$ "
6 Pcs.



FP453
Rectangular Tray
14" x 6 $\frac{1}{2}$ "
4 Pcs.



FP458
Olive/ Tapas Dish (5 Oz.)
4 $\frac{3}{8}$ " x 1 $\frac{1}{4}$ "
1 Dz.



FP459
Olive/ Tapas Dish (10 Oz.)
6 $\frac{1}{4}$ " x 1 $\frac{1}{4}$ "
6 Pcs.

Terra NEW

Terra draws inspiration from the company's origins; organic, earthy shapes that look like hand-thrown ceramic. Variations in color add to the uniqueness of each piece with a touch of charming rusticity, while the twice fired stoneware body makes it perfect for professional environments.

Due to the unique design of this product, careful handling is recommended.

Green

Sienna

Grey





Dinner Plate 11 1/2"
4 Pcs.

- FP384** Green
- FP399** Sienna
- FP414** Grey



Salad Plate 9 1/2"
6 Pcs.

- FP385** Green
- FP400** Sienna
- FP415** Grey



Dessert Plate 7 1/2"
6 Pcs.

- FP386** Green
- FP401** Sienna
- FP416** Grey



Large Bowl (40 Oz.)
D: 7 7/8" H: 2 1/4"
6 Pcs.

- FP387** Green
- FP402** Sienna
- FP417** Grey



Small Bowl (15 Oz.)
D: 5 5/8" H: 1 3/4"
6 Pcs.

- FP388** Green
- FP403** Sienna
- FP418** Grey



Au Gratin (5 Oz.)
L: 5 1/8" W: 3 1/8" H: 1 3/4"
2 Pcs.

- FP393** Green
- FP408** Sienna
- FP423** Grey



Au Gratin (30 Oz.)
D: 6 1/2" H: 3"
2 Pcs.

- FP394** Green
- FP409** Sienna
- FP424** Grey



Small Casserole With Lid (17 Oz.)
D: 5 1/2" H: 3 3/4"
2 Pcs.

- FP395** Green
- FP410** Sienna
- FP425** Grey



Oval Baker (22 Oz.)
L: 8 1/8" W: 5 1/8" H: 1 3/4"
1 Pc.

- FP756** Sienna



Oval Baker (40 Oz.)
L: 11 3/8" W: 6 3/8" H: 2 1/8"
1 Pc.

- FP398** Green
- FP413** Sienna
- FP428** Grey



Oval Tray
L: 7 1/2" W: 5 1/4"
4 Pcs.

- FP750** Green
- FP753** Sienna
- FP757** Grey



Oval Tray
L: 9 1/2" W: 6 1/2"
4 Pcs.

- FP751** Green
- FP754** Sienna
- FP758** Grey



Oval Tray
L: 11 1/2" W: 7 1/2"
4 Pcs.

- FP752** Green
- FP755** Sienna
- FP759** Grey



*Oven Safe: 428°F (220°C) approx. 1 hour. When taking product out of the oven It is important to put it on neutral temperature surface & to use oven mitts.



Shown Slate Gourmet Plate 11 ¼", Stllo Collection



Glacier

Slate

Onyx

Reflections **NEW**

Reflections, A Canvas for Chefs is a collection perfectly adaptable to a variety of cuisines like Asian, Latin American, and Mediterranean to name a few. The possibilities are defined by the Chef's imagination.



Side Plate 7 1/2" ★
1 Dz.

FP237 Onyx
FP250 Glacier
FP263 Slate



Salad/Dessert Plate 9" ★
1 Dz.

FP236 Onyx
FP249 Glacier
FP262 Slate



Dinner Plate 11" ★
1 Dz.

FP235 Onyx
FP248 Glacier
FP261 Slate



Gourmet Plate 7"
1 Dz.

FP247 Onyx
FP260 Glacier
FP273 Slate



Gourmet Plate 7 7/8"
1 Dz.

FP246 Onyx
FP259 Glacier
FP272 Slate



Gourmet Plate 9 1/2"
1 Dz.

FP245 Onyx
FP258 Glacier
FP271 Slate



Gourmet Plate 10 1/2"
1 Dz.

FP244 Onyx
FP257 Glacier
FP270 Slate



Gourmet Plate 11 1/4"
6 Pcs.

FP286 Onyx
FP287 Glacier
FP288 Slate



Saucepan with Handles
T: 8 1/2" M: 9" H: 1 1/2"
6 Pcs.

FP240 Onyx
FP253 Glacier
FP266 Slate



Round Bowl (12 Oz.)
D: 4 7/8" H: 2 1/8"
3 Dz.

FP242 Onyx
FP255 Glacier
FP268 Slate



Round Bowl (17 Oz.)
D: 5 3/8" H: 2 1/2"
2 Dz.

FP239 Onyx
FP252 Glacier
FP265 Slate



Flair Bowl (13 Oz.)
D: 4 7/8" H: 2 3/8"
6 Pcs.

FP241 Onyx
FP254 Glacier
FP267 Slate



Bouillon (7 1/2 Oz.)
D: 3 7/8" H: 2 3/8"
6 Pcs.

FP243 Onyx
FP256 Glacier
FP269 Slate



Mug (10 1/2 Oz.)
T: 3 1/4" M: 4 3/4" H: 4"
1 Dz.

FP238 Onyx
FP251 Glacier
FP264 Slate



*Oven Safe: 356°F (180°C) approx. 30 minutes.
When taking product out of the oven it is important to put it on neutral temperature surface & to use oven mitts.



Reflections Blue Band

NEW



The light touch of a blue band will bring focus to any menu by framing the ingredients with delicate sophistication. Mix with Reflections Glacier to bring more versatility to any tabletop.



FP466 ★
Side Plate 7 1/2"
1 Dz.



FP465 ★
Salad/Dessert Plate 9"
1 Dz.



FP464 ★
Dinner Plate 11"
1 Dz.



FP470
Gourmet Plate 7"
1 Dz.



FP469
Gourmet Plate 7 7/8"
1 Dz.



FP468
Gourmet Plate 9 1/2"
1 Dz.



FP467
Gourmet Plate 10 1/2"
1 Dz.



*Oven Safe: 356°F (180°C) approx. 30 minutes. When taking product out of the oven it is important to put it on neutral temperature surface & to use oven mitts.



Forest Green

Sand

Valentina NEW

Drawing from Mexican traditions, Valentina combines a botanical look with an artisanal touch to create a unique background for any menu.



Side Plate 7 1/2" ★
1 Dz.

FP768 Forest Green
FP772 Sand



Dinner Plate 11" ★
1 Dz.

FP767 Forest Green
FP771 Sand



Gourmet Plate 7" ★
1 Dz.

FP766 Forest Green
FP770 Sand



Gourmet Plate 10 1/2" ★
1 Dz.

FP765 Forest Green
FP769 Sand



*Oven Safe: 356°F (180°C) approx. 30 minutes. When taking product out of the oven it is important to put it on neutral temperature surface & to use oven mitts.

Accessories

NEW

Mix wood and metal accessories to serve up delicious appetizers or entrées.





FP315
Taco Holder ⅔ Black PVD
H: 2" L: 8 ½" W: 4"
2 Dz.



FP316
French Fry Holder Black PVD
H: 4" L: 4 ½" W: 5 ¼"
2 Dz.



FP317*
Wood Tray 3 Double Wells
14 ½" x 4 ¾"
6 Pcs.
(Fits: FP316, FP243, FP256, FP269, FP315)



FP318*
Wood Soup/Salad/Sandwich Board
14" x 8"
6 Pcs.
(Fits: FP318, FP242, FP255, FP268, FP239,
FP252, FP265, FP241, FP254, FP267)



Shown: FP315, FP316, FP317





Developed for professional use; superior mechanical resistance.

Square Up	246
Appetizer	247
Daring	247



Stackability – Product design specifically made for safe stacking.



Square Up

Popular square shapes get a boost from flared sides.



FF192
Side Plate 6 1/2"
3 Dz.

FF193
Side/Share Plate 7 1/2"
2 Dz.

FF194
Brunch/Salad Plate 9"
1 Dz.

FF195
Dinner Plate 11"
6 Pcs.



FF196
Rectangular Platter
12 1/2" x 8"
1 Dz.



FF198
Flared Bowl (4 1/2 Oz.)
L: 3 3/4" W: 3 3/4" H: 1 3/4"
3 Dz.



FF201
Flared Bowl (2 Oz.)
L: 3" W: 3" H: 1 1/8"
3 Dz.

FF200
Flared Bowl (4 Oz.)
L: 4" W: 4" H: 1 1/2"
3 Dz.

FF199
Flared Bowl (14 Oz.)
L: 5" W: 5" H: 2 3/8"
3 Dz.



FF202
Bowl (1 1/2 Oz.)
L: 3" W: 2 1/2" H: 3/8"
3 Dz.

Appetizer

Accessory pieces that fit everything from hors d'oeuvres to condiments.



R0738
Spoon 4 1/8" (1/2 oz.)
2 Dz.



R0735
Deep Square Bowl
3 3/8" (4 1/2 Oz.)
2 Dz.



R0741
Deep Bowl 3 3/4" (5 Oz.)
2 Dz.



R0736
Rectangular Plate
5 5/8" x 2 3/4"
2 Dz.

Daring

Extra Strong Porcelain accessory pieces designed to complement our Intensity White and Restaurant White lines.



G3765 •
Bouillon (8 Oz.)
H: 2 1/8" M: 4"
2 Dz.



G3745 •
Coffee/Teacup (7 1/4 Oz.)
H: 2 3/8" M: 4 1/4"
2 Dz.

G3751
Double Well Saucer 6"
2 Dz.



G3752
Mug (10 Oz.)
H: 3 1/2" M: 4 1/4"
2 Dz.







Preferred by high volume establishments for strength, stackability, bacteria resistance, style and value.

Brush Blue Jean	250
Restaurant White	252
Intensity White	254
Evolutions	256



Fully Tempered – Preferred by high volume establishments for strength, style and value.



0% Bacteria – Opal® material is non-porous and resistant to bacteria.



Stackability – Product design specifically made for safe stacking.



Brush Blue Fean

Brush is ideal for serving menus with dietary restrictions.





H3609
B&B Plate 6"
2 Dz.



H3608
Side Plate 7 1/2"
2 Dz.



H3607
Lunch Plate 9 1/4"
2 Dz.



P3946
Dinner Plate 10"
1 Dz.



H3610
Soup Plate (23 Oz.)
9"
2 Dz.



H3611
Fruit Bowl (3 1/2 Oz.)
4 3/8"
3 Dz.



H3615 •
Bowl (10 1/2 Oz.)
4 3/8"
3 Dz.



H3612 •
Square Dish (8 Oz.)
4 1/4"
2 Dz.



Restaurant White

Elegant and clean, Restaurant White pairs well with all Opal Dinnerware products.



58621
Narrow Rim B&B Plate 6"
2 Dz.

57974
Narrow Rim Side Plate 7 1/2"
2 Dz.

57975
Narrow Rim Lunch Plate 9 1/4"
2 Dz.

N6393
Narrow Rim Dinner Plate 10 1/4"
1 Dz.



22506
Wide Rim B&B Plate 6"
2 Dz.

22530
Wide Rim Side Plate 7 1/2"
2 Dz.

22522
Wide Rim Lunch Plate 9 3/8"
2 Dz.

P3972
Wide Rim Dinner Plate 10"
2 Dz.
(Old SKU: 24742)



29337
Hospital Heat System Plate 8 3/4"
2 Dz.



L6850
Deep Plate 9 3/4"
1 Dz.



P3967
Oval Platter 11 1/2"
1 Dz.



22514
Rim Soup (23 Oz.) 9"
2 Dz.



25285
Fruit Bowl (3 1/2 Oz.) 4 3/4"
3 Dz.



28891 ●
Double Handled Bowl (10 1/2 Oz.)
H: 2 1/4" M: 4"
2 Dz.



25293
Grapefruit Bowl (7 Oz.) 6 1/4"
3 Dz.



43319 ●
Bowl (10 1/2 Oz.)
4 3/4"
3 Dz.



50061
Multi-Usage Bowl (15 Oz.)
6 1/4"
2 Dz.



25269 ●
Tall Cup (7 1/2 Oz.)
H: 2 7/8" M: 3"
4 Dz.

22712
Saucer 5 7/8"
3 Dz.



14611 ●
Cup (8 Oz.)
H: 2 3/4" M: 3 1/4"
3 Dz.

22712
Saucer 5 7/8"
3 Dz.



36140 ●
Mug (8 Oz.)
H: 3 1/2" T: 2 3/4" B: 2 1/2" M: 4"
3 Dz.



64733 ●
Mug (10 Oz.)
H: 3 1/2" M: 4 3/8"
3 Dz.



Intensity White

Elegant and clean, Intensity White pairs well with all Opal® Dinnerware products.





V1540
B&B Plate 6 ¼"
2 Dz.



V1539
Salad Plate 8"
2 Dz.

V1537
Plate 9 ½"
2 Dz.



V1536
Banquet Plate 10"
1 Dz.



V1653
Dinner Plate 10 ¾"
1 Dz.



V1538
Rim Soup/Pasta Bowl (11 ¾ Oz.)
8 ½"
2 Dz.

Evolutions

Casual dining to buffets, Evolutions offers the complete solution with a mix of plates, platters and serving pieces for every cuisine.



Shown Coupe Plate 10", Bowl (13 ½ Oz.)



N9362
Coupe Dessert Plate 7 ¼"
2 Dz.



N9361
Coupe Plate 10"
2 Dz.



P1122
Granite Coupe Dinner Plate 10 ⅝"
2 Dz.

N9360
Coupe Plate 10 ⅝"
2 Dz.



N9411
Coupe Soup (26 ¼ Oz.)
7 ¾"
2 Dz.



L2805
Pasta Plate (18 ½ Oz.)
11 ⅞"
1 Dz.

P0447
Deep Plate (40 ½ Oz.)
10 ⅞"
2 Dz.



L2810
Pizza Plate 12 ½"
1 Dz.



P1139
Black Pizza Plate 12 ½"
1 Dz.



V2159
Bowl (13 ½ Oz.) 4 ⅝"
3 Dz.

N9395
Bowl (25 ¼ Oz.) 5 ⅝"
2 Dz.

N9365
Bowl (33 ¾ Oz.) 7"
1 Dz.

D7410
Bowl (71 ¼ Oz.) 8 ¼"
1 Dz.



P9773 ●
Bowl (20 ¼ Oz.) 6 ⅞"
1 Dz.

P9772 ●
Bowl (32 Oz.) 8 ¼"
1 Dz.

P9771 ●
Bowl (47 Oz.) 9 ⅞"
1 Dz.



N9364
Oval Platter
13" x 9 ¾"
1 Dz.



L2808
Rectangular Plate 8 ¼" x 7 ¼"
2 Dz.

L2804
Rectangular Plate 11" x 9"
2 Dz.

E8007
Rectangular Plate 13 ¾" x 9 ¼"
6 Pcs.



***P0310**
Smart Cuisine Crème Brulee Dish (9 ½ Oz.)
L: 5 ⅞" W: 5 ½" H: 1 ¼"
1 Dz.



***P0887**
Smart Cuisine Oval Dish (17 Oz.)
L: 8 ¼" W: 5 ⅞" H: 1 ½"
6 Pcs.







Preferred by high volume establishments for strength, style and value.

Arcade	260
Fleur	260
ROC	260
Stack Bowls	260
Non-Tempered	
Dessert	261



Stackability – Product design specifically made for safe stacking.



Glass Dinnerware

From vintage to classic, Arcoroc glass dinnerware is perfect for banquets and buffets everywhere.



J0232
Fleur Dessert Plate 7 1/2"
3 Dz.

J0856
Fleur Dinner Plate 9"
3 Dz.



J0226
Fleur Soup/Deep Salad Bowl (15 Oz.)
8"
3 Dz.



01141
ROC Dinner Plate 9 1/8"
3 Dz.



01166
ROC Dessert Plate 6"
3 Dz.

01158
ROC Salad Plate 7 1/2"
3 Dz.



00556
Arcade Bowl (11 Oz.) 5"
12 Dz.

M0090
Arcade Bowl (22 Oz.) 6"
2 Dz.



N7945
Arcade Bowl (38 Oz.) 7"
1 Dz.

N2608
Arcade Bowl (72 Oz.) 9"
1 Dz.



E9155*
Stack Bowl (1 1/4 Oz.) 2 1/2"
3 Dz.

E9156*
Stack Bowl (2 3/4 Oz.) 3"
3 Dz.

E9157*
Stack Bowl (5 Oz.) 3 1/2"
3 Dz.



E9158*
Stack Bowl (7 1/2 Oz.) 4 1/8"
3 Dz.

E9159*
Stack Bowl (12 Oz.) 4 3/8"
3 Dz.



G2712*
Stack Bowl (39 Oz.) 6 3/8"
3 Dz.



V7655*
Stack Bowl (144 Oz.)
10 1/4"
6 Pcs.



Dessert*

Showcase your sweet creations with sophistication and style.

**Non-tempered*



L6689
Maeva Diamant Dessert Bowl (6 ¾ Oz.)
H: 2 ¾" T: 4" B: 2" M: 4"
2 Dz.



58010
Palmier Dessert (7 Oz.)
H: 3 ⅝" T: 4 ⅞"
B: 2 ¾" M: 4 ⅞"
2 Dz.



58012
Palmier Dessert (12 ½ Oz.)
H: 7 ⅞" T: 4 ¾"
B: 3 ¼" M: 4 ¾"
2 Dz.



V7429
Swirl Optic Dessert (7 Oz.)
H: 3 ⅞" T: 3 ⅞"
B: 2 ¾" M: 3 ⅞"
2 Dz.



V7431
Swirl Optic Dessert (12 Oz.)
H: 3 ¾" T: 4 ⅞"
B: 3 ¼" M: 4 ⅞"
2 Dz.

Flatware



Shown Ezzo Collection



Crafted Excellence

Crafted from the highest quality stainless steel which is an alloy of steel with chromium and/or added elements resistant to rust and corrosion.

What is Stainless Steel?

Stainless steel is a durable and affordable metal that is used for a wide variety of purposes. It's strong, making it perfect for flatware and it's resistant to corrosion, so it can last a long time without being replaced.

Chromium

Chromium is an essential element used in stainless steel for its durability and rust/stain resistant properties.

Nickel

Nickel is an element added to bring strength to the flatware as well as a soft luster similar to silver, producing a bright and polished look and also gives added resistance to corrosion.

Chromium / Nickel

1st Number / 2nd Number

18/10 Stainless Steel *(304 Stainless)*

Contains 18% chromium and 10% nickel. 18/10 is the highest quality stainless steel. This stainless is non-magnetic therefore it will not work in flatware retrievers.

18/0 Stainless Steel *(420 Stainless)*

Contains 18% chromium and 0% nickel. 18/0 has an economic value which is usually seen at casual and high volume restaurants. This stainless steel is magnetic, therefore, it will work in flatware retrievers.

13/0 Stainless Steel *(410 Stainless)*

Contains 13% chromium and 0% nickel. This steel is used to make knives due to the softer properties. This stainless steel is magnetic, therefore, it will work in flatware retrievers.

Medium Weight

Medium weight flatware are patterns that are more economical and tend to be trendy and transitional. These patterns are ideal in casual, high-paced establishments as well as mid-level restaurants.

Heavy Weight

Heavy weight flatware are upscale patterns that can be found in high-end restaurants, upscale casual and fine dining and in hotels. They tend to be more modern in design.



Modern

Modern flatware is sleek, minimalist designs with clean lines. A blend of functionality with contemporary aesthetics.



Classic

Classic flatware designs feature balanced proportions and timeless elegance that is not ornate or embellished.



Updated Traditional

Updated traditional flatware blends timeless motifs with contemporary touches, featuring refined details and modernized shapes for a chic yet classic appeal.



Transitional

Transitional flatware bridges modern and casual styles, offering a harmonious blend of traditional elegance and modern simplicity.





Modern

The modern selection of flatware features sleek, minimalist designs with clean lines. Modern flatware offers a blend of functionality with contemporary aesthetics.



Kya	268
Kya Sand	268
Diaz	269
Ezzo	269
Knox	270
Living Satin	270
Living Mirror	271
Black Oak	271
Black Oak Satin NEW	272
Lazzo	272
Neo NEW	273
Stilo NEW	273
Blake NEW	275
Greenwich	275



Contains 18% chromium and 10% nickel. 18/10 is the highest quality stainless steel. This stainless is non-magnetic therefore it will not work in flatware retrievers.



Contains 18% chromium and 0% nickel. 18/0 has an economic value which is usually seen at casual and high volume restaurants. This stainless steel is magnetic, therefore, it will work in flatware retrievers



Kya

BY Chef&Sommelier

Subtle curves create understated elegance.

- | | |
|---|--|
| T5401
Dinner Fork 8 1/8" 3 Dz. | T5409
Soup Spoon 7" 3 Dz. |
| T5402
Dinner Spoon 8 3/8" 3 Dz. | T5411
Demitasse Spoon 4 1/2" 3 Dz. |
| T5404
Dinner Knife (SH) 9 3/8" 3 Dz. | T5427
Butter Spreader 6 3/8" 3 Dz. |
| T5405
Dessert Fork 7 3/8" 3 Dz. | T5428
US Teaspoon 6 1/8" 3 Dz. |
| T5406
Dessert Spoon 7 3/8" 3 Dz. | T5429
Salad Fork 7 1/2" 3 Dz. |
| T5408
Dessert Knife (SH) 8 1/4" 3 Dz. | |



Kya Sand

BY Chef&Sommelier

A unique two-tone extension to our popular Kya collection featuring a mirror finish top and subtle sand handle for exceptional elegance and style.

- | | |
|--|--|
| FJ701
Dinner Fork 8 1/8" 3 Dz. | FJ708
US Teaspoon 6 1/8" 3 Dz. |
| FJ704
Dinner Knife (SH) 9 3/8" 3 Dz. | FJ709
Salad Fork 7 1/2" 3 Dz. |
| FJ706
Dessert Spoon 7 3/8" 3 Dz. | FG727
Butter Spreader 6 1/2" 3 Dz. |





Diaz

BY Chef&Sommelier

Flared handles are classic yet contemporary.

T5101
Dinner Fork 8 ¼" 3 Dz.

T5102
Dinner Spoon 8 ¼" 3 Dz.

T5104
Dinner Knife (SH) 9 ¾" 3 Dz.

T5105
Dessert Fork 7 ¼" 3 Dz.

T5106
Dessert Spoon 7 ¼" 3 Dz.

T5109
Soup Spoon 7" 3 Dz.

T5111
Demitasse Spoon 4 ½" 3 Dz.

T5121
Cocktail/Oyster Fork 5 ⅝" 3 Dz.

T5127
Butter Spreader 6 ⅝" 3 Dz.

T5128
US Teaspoon 6 ⅞" 3 Dz.

T5129
Salad Fork 7 ¼" 3 Dz.



Exzo

BY Chef&Sommelier

Angled handles add a fresh hint of jazz.

T5201
Dinner Fork 8 ¼" 3 Dz.

T5204
Dinner Knife (SH) 9 ¾" 3 Dz.

T5206
Dessert Spoon 7 ¼" 3 Dz.

T5209
Soup Spoon 7" 3 Dz.

T5221
Cocktail/Oyster Fork 5 ⅝" 3 Dz.

T5227
Butter Spreader 6 ⅝" 3 Dz.

T5228
US Teaspoon 6 ⅞" 3 Dz.

T5229
Salad Fork 7 ¼" 3 Dz.





Knox

BY Chef&Sommelier

Rounded heads with a hearty, hammered texture embellish the handles and discreetly hides fingerprints.

FK801
Dinner Fork 8 1/2" 3 Dz.

FK802
Dinner Spoon 8 5/8" 3 Dz.

FK804
Dinner Knife (SH) 9 1/2" 3 Dz.

FK806
Dessert Spoon 7 7/8" 3 Dz.

FK809
Soup Spoon 7 1/4" 3 Dz.

FK828
US Teaspoon 7 3/8" 3 Dz.

FK829
Salad/Dessert Fork 7 1/2" 3 Dz.



Living Satin

BY **Sola**

Classic satin touch to the contemporary mirror adds flair to the modern shape.

MB324
Table Knife (SH) 9" 1 Dz.

MB323
Table Fork 8 1/8" 1 Dz.

MB322
Tablespoon 8 1/8" 1 Dz.

MB327
Dessert Fork 7 3/8" 1 Dz.

MB326
Dessert Spoon 7 3/8" 1 Dz.

MB337
Soup Spoon 7 1/8" 1 Dz.

MB341
American Teaspoon 6 1/2" 1 Dz.

MB329
Coffee Spoon 4 3/8" 1 Dz.

MB331
Fish Knife 8 1/8" 1 Dz.





Living Mirror

BY **Sola**

Sleek contemporary handles make a dramatic statement for a variety of table settings.

MB298
Table Knife (SH) 9" 1 Dz.

MB297
Table Fork 8 1/8" 1 Dz.

MB296
Tablespoon 8 1/8" 1 Dz.

MB300
Dessert Fork 7 3/8" 1 Dz.

MB299
Dessert Spoon 7 3/8" 1 Dz.

MB321
American Teaspoon 6 1/2" 1 Dz.

MB302
Teaspoon 5 1/2" 1 Dz.

MB303
Coffee Spoon 4 3/8" 1 Dz.



Black Oak

BY **Chef&Sommelier**

Dark, bark-like handles that beautifully curve to meet refined heads.

FL901
Dinner Fork 8 1/4" 3 Dz.

FL902
Dinner Spoon 8 3/8" 3 Dz.

FL904
Dinner Knife (SH) 9" 3 Dz.

FL906
Dessert Spoon 7 7/8" 3 Dz.

FL909
Soup Spoon 7" 3 Dz.

FL928
US Teaspoon 6 7/8" 3 Dz.

FL929
Salad/Dessert Fork 7 1/4" 3 Dz.

FMO05
Dessert Fork 7 1/4" 3 Dz.

FMO08
Dessert Knife 8 1/2" 3 Dz.

FMO26
Steak Knife 9 1/2" 3 Dz.

FMO12
Fish Fork 7 1/4" 3 Dz.

FL913
Fish Knife 8 1/8" 3 Dz.

FL940
Demitasse Spoon 4 1/2" 3 Dz.

FL927
Butter Spreader 6 5/8" 3 Dz.





Black Oak Satin

NEW

BY Chef&Sommelier

The sleek satin look of this bark like design brings a modern twist to the trendy natural aesthetic.

FN995

Dinner Fork 8 ¼" 3 Dz.

FN996

Dinner Knife (SH) 9" 3 Dz.

FN997

Dessert Spoon 7 ⅞" 3 Dz.

FN998

Salad/Dessert Fork 7 ¼" 3 Dz.

FP001

US Teaspoon 6 ⅞" 3 Dz.



Lasso

BY Chef&Sommelier

Gentle curves. Graceful tapers.
Essential and timeless.

T4701

Dinner Fork 8 ¼" 3 Dz.

T4702

Dinner Spoon 8 ¼" 3 Dz.

T4704

Dinner Knife (SH) 9 ½" 3 Dz.

T4706

Dessert Spoon 7 ¼" 3 Dz.

T4709

Soup Spoon 6 ⅞" 3 Dz.

T4711

Demitasse Spoon 4 ½" 3 Dz.

T4728

US Teaspoon 6" 3 Dz.

T4729

Salad Fork 7 ¼" 3 Dz.

T0426

Steak Knife (SH) 9 ½" 3 Dz.

T4727

Butter Spreader 6 ½" 3 Dz.

T0418

Iced Tea Spoon 7 ⅞" 3 Dz.





Neo NEW

BY **abert**

Wide and straight handles make a bold statement.

FP565
Dinner Fork 8 1/8" 1 Dz.

FP566
Dinner Knife (SH) 9 1/8" 1 Dz.

FP567
Dessert Spoon 7 1/2" 1 Dz.

FP568
Salad/Dessert Fork 7 1/2" 1 Dz.

FP569
Teaspoon 5 13/16" 1 Dz.

FP570
Dinner Spoon 8 1/4" 1 Dz.

FP658
Soup Spoon 7 1/8" 1 Dz.

FP659
Mocca Spoon 4 1/2" 1 Dz.

FP660
Butter Knife 6 7/8" 1 Dz.



Stilo NEW

BY **abert**

A strong personality; tapered and rounded handles with a lance shaped knife blade. An unconventional pattern with great style.

FP551
Dinner Fork 7 7/8" 1 Dz.

FP552
Dinner Knife (SH) 9 3/8" 1 Dz.

FP553
Dessert Spoon 7 1/8" 1 Dz.

FP554
Salad/Dessert Fork 7 1/8" 1 Dz.

FP555
Teaspoon 5 1/2" 1 Dz.

FP556
Dinner Spoon 7 13/16" 1 Dz.

FP557
Soup Spoon 7" 1 Dz.

FP672
Mocca Spoon 4 1/8" 1 Dz.

FP673
Butter Spreader 6 1/2" 1 Dz.



Shown Blake Collection



Blake NEW

BY ARCOROC

Exuding a contemporary and elegant aura, this forged Black PVD finish is poised to enhance both the ambiance and dining experience within any restaurant setting.



FP322
Dinner Fork 7 7/16" 1 Dz.

FP324
Dessert Spoon 7 5/8" 1 Dz.

FP323
Dinner Knife (SH) 8 13/16" 1 Dz.

FP325
Salad/Dessert Fork 6 7/8" 1 Dz.

FP326
Teaspoon 6 1/8" 1 Dz.



Greenwich

BY ARCOROC

Sleek softly curved heads with squared ends and narrow handles in a polished, modernly casual design.



FL501
Dinner Fork 7 7/8" 1 Dz.

FL509
Soup Spoon 6 1/2" 1 Dz.

FL502
Dinner Spoon 8" 1 Dz.

FL528
US Teaspoon 6 3/4" 1 Dz.

FL504
Dinner Knife (SH) 9" 1 Dz.

FL529
Salad/Dessert Fork 6 7/8" 1 Dz.

FL506
Dessert Spoon 7 1/2" 1 Dz.





Classic

Classic flatware designs feature balanced proportions and timeless elegance that is not ornate or embellished.



Matisse NEW	278
Matisse Vintage NEW	278
Matisse Vintage Gold NEW	279
Latham	279
Latham Sand	280
Burlington	280
Elegant NEW	281
Milord NEW	281
Vesca	282
Matiz	283
Satineo	283



Contains 18% chromium and 10% nickel. 18/10 is the highest quality stainless steel. This stainless is non-magnetic therefore it will not work in flatware retrievers.



Contains 18% chromium and 0% nickel. 18/0 has an economic value which is usually seen at casual and high volume restaurants. This stainless steel is magnetic, therefore, it will work in flatware retrievers



Matisse

NEW

BY **abert**

A cutlery model with simple and soft features, for a fashionable and elegant table setting.

FP474

Dinner Fork 8 1/8" 1 Dz.

FP475

Dinner Knife (SH) 9 3/8" 1 Dz.

FP477

Dessert Spoon 7" 1 Dz.

FP478

Salad/Dessert Fork 7" 1 Dz.

FP479

Teaspoon 5 3/8" 1 Dz.

FP480

Soup Spoon 6 1/8" 1 Dz.

FP642

Mocca Spoon 4 1/2" 1 Dz.

FP643

Fish Fork 8" 1 Dz.

FP644

Fish Knife 8 1/4" 1 Dz.

FP645

Iced Tea Spoon 8 1/4" 1 Dz.

FP646

Butter Spreader 7" 1 Dz.



Matisse Vintage

NEW

BY **abert**

A cutlery model with simple and soft features in an antique finish for a fashionable and elegant table setting.

FP481

Dinner Fork 8 1/8" 1 Dz.

FP482

Dinner Knife (SH) 9 3/8" 1 Dz.

FP483

Dessert Spoon 7" 1 Dz.

FP484

Salad/Dessert Fork 7" 1 Dz.

FP485

Teaspoon 5 3/8" 1 Dz.

FP486

Soup Spoon 6 1/8" 1 Dz.

FP647

Mocca Spoon 4 1/2" 1 Dz.

FP648

Butter Spreader 7" 1 Dz.





Matisse Vintage Gold

NEW

BY **abert**

A cutlery model with simple and soft features in an elegant gold antique finish for a fashionable and trendy table setting.

FP701
Dinner Fork 8 1/8" 1 Dz.

FP702
Dinner Knife (SH) 9 3/8" 1 Dz.

FP703
Dessert Spoon 7" 1 Dz.

FP704
Salad/Dessert Fork 7" 1 Dz.

FP705
Teaspoon 5 3/8" 1 Dz.

FP706
Soup Spoon 6 13/16" 1 Dz.



Latham

BY **ARCOROC**

These arcs get high marks for comfort and style.

T3601
Dinner Fork 8 1/4" 1 Dz.

T3602
Dinner Spoon 8 1/4" 1 Dz.

T3604
Dinner Knife (SH) 9 1/4" 1 Dz.

T3606
Dessert Spoon 7" 1 Dz.

T3611
Demitasse Spoon 4 3/8" 1 Dz.

T3621
Oyster/Cocktail Fork 6" 1 Dz.

T3627
Butter Spreader 7" 1 Dz.

T3628
US Teaspoon 6" 1 Dz.

T3629
Salad Fork 7" 1 Dz.





Latham Sand

BY ARCOROC

These arcs get high marks for comfort and style with a two tone finish.

FJ801
Dinner Fork 8 1/4" 1 Dz.

FJ804
Dinner Knife (SH) 9 1/4" 1 Dz.

FJ806
Dessert Spoon 7" 1 Dz.

FJ909
Butter Spreader 7" 1 Dz.

FJ911
Demitasse Spoon 4 3/8" 4 Dz.

FJ828
US Teaspoon 6" 1 Dz.

FJ829
Salad Fork 7" 1 Dz.



Burlington

BY Chef&Sommelier

Sophisticated, trendy, versatile Burlington creates a striking presentation for any table-scape.



Amuse/Tasting Spoon

EQ293
Table Knife (SH) 9 1/4" 1 Dz.

EQ290
Table Fork 8 1/4" 1 Dz.

EQ289
Table/Serving Spoon 8 1/8" 1 Dz.

EQ291
Salad/Dessert Fork 7" 1 Dz.

EQ284
Dessert/Oval Bowl Soup Spoon
6 13/16" 1 Dz.

EQ285
Round Bowl Soup Spoon 6 3/8" 1 Dz.

EQ283
American Teaspoon 6" 1 Dz.

EQ287
Coffee Spoon 5 3/8" 1 Dz.

EQ286
Iced Teaspoon 8" 1 Dz.

EQ292
Cocktail Fork 6" 1 Dz.

EQ294
Butter Knife 6 3/4" 1 Dz.

EQ295
Steak Knife (SH) 9" 1 Dz.

EQ288
Amuse/Tasting Spoon 5 1/4" 1 Dz.





Elegant NEW

BY **abert**

Geometric and harmonious lines for elegant and refined cutlery, appropriate for all occasions.

FP494
Dinner Fork 8 3/8" 1 Dz.

FP502
Teaspoon 5 1/2" 1 Dz.

FP495
Dinner Knife (SH) 9 1/2" 1 Dz.

FP504
Soup Spoon 7 1/4" 1 Dz.

FP499
Dessert Spoon 7 1/4" 1 Dz.

FP652
Mocca Spoon 4 1/2" 1 Dz.

FP501
Salad/Dessert Fork 7 1/4" 1 Dz.

FP653
Butter Knife 7" 1 Dz.



Milord NEW

BY **abert**

Simple and smooth lines complement most decors.

FP558
Dinner Fork 7 7/8" 1 Dz.

FP564
Soup Spoon 6 3/4" 1 Dz.

FP559
Dinner Knife (SH) 9 1/8" 1 Dz.

FP563
Dinner Spoon 7 7/8" 1 Dz.

FP560
Dessert Spoon 7" 1 Dz.

FP666
Mocca Spoon 4 1/8" 1 Dz.

FP561
Salad/Dessert Fork 7" 1 Dz.

FP667
Iced Tea Spoon 7 3/8" 1 Dz.

FP562
Teaspoon 5 1/4" 1 Dz.

FP668
Butter Spreader 6 1/2" 1 Dz.





Vesca

BY ARCOROC

Simple and straightforward has never seemed so fresh.

! Also has serving accessories! See Page 307.

T1801
Dinner Fork 8" 1 Dz.

T1802
Dinner Spoon 8" 1 Dz.

T1804
Dinner Knife (SH) 9 1/4" 1 Dz.

T1805
Dessert Fork 7 1/8" 1 Dz.

T1806
Dessert Spoon 7 1/8" 1 Dz.

T1808
Dessert Knife (SH) 8 1/8" 1 Dz.

T1809
Soup Spoon 6 7/8" 1 Dz.

T1811
Demitasse Spoon 4 3/8" 1 Dz.

T1828
US Teaspoon 6" 1 Dz.

T1829
Salad Fork 7" 1 Dz.





Matiz

BY ARCOROC

Rounded ends bring dining full circle.

T1901
Dinner Fork 8" 1 Dz.

T1902
Dinner Spoon 8" 1 Dz.

T1904
Dinner Knife (SH) 9 1/4" 1 Dz.

T1906
Dessert Spoon 7 1/2" 1 Dz.

T1911
Demitasse Spoon 4 3/8" 1 Dz.

T1928
US Teaspoon 6" 1 Dz.

T1929
Salad Fork 7" 1 Dz.



Satineo

BY ARCOROC

Smooth lines in a subtle satin finish.



T7801
Dinner Fork 8 1/4" 4 Dz.

T7802
Dinner Spoon 8 1/4" 4 Dz.

T7804
Dinner Knife (SH) 9 3/8" 4 Dz.

T7806
Dessert Spoon 7 1/4" 4 Dz.

T7828
US Teaspoon 5 7/8" 4 Dz.

T7829
Salad Fork 7 1/8" 4 Dz.





Updated Traditional

Updated traditional flatware blends timeless motifs with contemporary touches, featuring refined details and modernized shapes for a chic yet traditional appeal.



Baguette Black	286
Baguette Vintage Stone Wash	286
Fluted	287
Orzon	287
Orzon Patina	288
Renzo	288
Renzo Patina	289
Rada NEW	289
Enrico VIII NEW	290
Victory NEW	290
Capitale	291
Harrison	291



Contains 18% chromium and 10% nickel. 18/10 is the highest quality stainless steel. This stainless is non-magnetic therefore it will not work in flatware retrievers.



Contains 18% chromium and 0% nickel. 18/0 has an economic value which is usually seen at casual and high volume restaurants. This stainless steel is magnetic, therefore, it will work in flatware retrievers

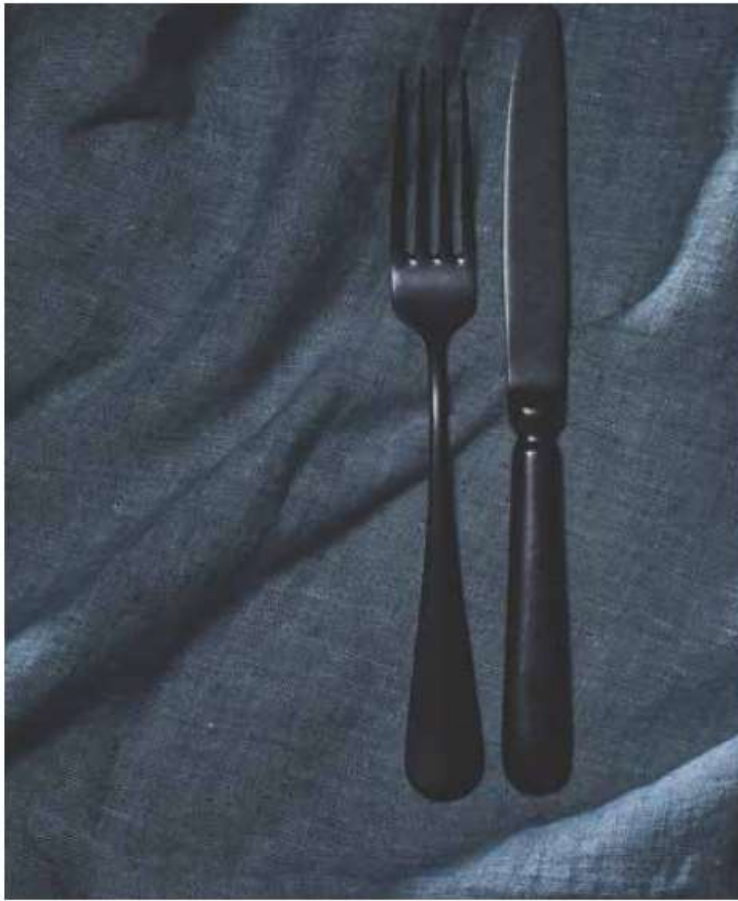

Baguette Black

BY  Sola

There's nothing traditional about this Baguette pattern. Black offers a bold statement for any table.

MB247
Table Knife (SH) 9" 1 Dz.

MB246
Table Fork 8 1/8" 1 Dz.

MB251
Dessert Knife 8" 1 Dz.

MB250
Dessert Fork 7 3/8" 1 Dz.

MB249
Dessert Spoon 7 3/8" 1 Dz.

MB253
American Teaspoon 6" 1 Dz.

MB248
Teaspoon 5 3/4" 1 Dz.

MB252
Coffee Spoon 4 1/2" 1 Dz.

MB254
Cake Fork 5 3/4" 1 Dz.



Baguette Vintage Stone Wash

BY  Sola

There is nothing traditional about this Baguette pattern. Rustic is this pattern's middle name. Ideal for a hand crafted look and feel.

FL941
Table Knife (SH) 9" 1 Dz.

FL942
Table Fork 8 1/8" 1 Dz.

FL946
Tablespoon 8 1/8" 1 Dz.

FL948
Dessert Fork 7 3/8" 1 Dz.

FL951
Dessert Spoon 7 3/8" 1 Dz.

FL953
American Teaspoon 6" 1 Dz.

FL952
Teaspoon 5 3/4" 1 Dz.





Fluted

BY Chef&Sommelier

Fluted handles separated by bands at the bottom and neck create a traditional poised look.

FL201
Dinner Fork 8 1/8" 3 Dz.

FL202
Dinner Spoon 8 3/8" 3 Dz.

FL204
Dinner Knife (SH) 8 7/8" 3 Dz.

FL206
Dessert Spoon 7 7/8" 3 Dz.

FL209
Soup Spoon 7" 3 Dz.

FL211
Demitasse Spoon 4 1/2" 3 Dz.

FL218
Iced Teaspoon 7" 3 Dz.

FL221
Cocktail/Oyster Fork 5 3/4" 3 Dz.

FL227
Butter Spreader 6 1/2" 3 Dz.

FL228
US Teaspoon 6 3/8" 3 Dz.

FL229
Salad Fork 7 1/8" 3 Dz.



Orson

BY Chef&Sommelier

A twist on traditional with reeded trim and curved details.

T4801
Dinner Fork 8 1/8" 3 Dz.

T4804
Dinner Knife (SH) 9 3/8" 3 Dz.

T4806
Dessert Spoon 7 1/8" 3 Dz.

T4809
Soup Spoon 6 7/8" 3 Dz.

T4828
US Teaspoon 6" 3 Dz.

T4829
Salad Fork 7 1/4" 3 Dz.





Orzon Patina

BY Chef&Sommelier

The soft, grey, lustrous finish of Orzon Patina is created from a highly distressed tumbled process for a complete vintage look from blade to handle.

FK401
Dinner Fork 8 1/8" 3 Dz.

FK404
Dinner Knife (SH) 9 5/8" 3 Dz.

FK406
Dessert Spoon 7 1/8" 3 Dz.

FK428
US Teaspoon 6" 3 Dz.

FK429
Salad Fork 7 1/4" 3 Dz.



Renzo

BY Chef&Sommelier

Gentle ridges create perfect style and balance.

T4901
Dinner Fork 8 1/8" 3 Dz.

T4902
Dinner Spoon 8 1/4" 3 Dz.

T4904
Dinner Knife (SH) 9 5/8" 3 Dz.

T4905
Dessert Fork 7 1/4" 3 Dz.

T4906
Dessert Spoon 7 1/4" 3 Dz.

T4908
Dessert Knife (SH) 8 3/8" 3 Dz.

T4909
Soup Spoon 6 7/8" 3 Dz.

T4911
Demitasse Spoon 4 1/2" 3 Dz.

T4927
Butter Spreader 6 1/2" 3 Dz.

T4928
US Teaspoon 6" 3 Dz.

T4929
Salad Fork 7 1/4" 3 Dz.





Renzo Patina

BY Chef&Sommelier

Vintage inspired, our Renzo Patina collection features a rumbled, antique distressed appearance from a tumbled process that brings traditional charm to the table. A soft, rich and warm finish brings this unique artisan collection to life.

FK501
Dinner Fork 8 1/8" 3 Dz.

FK504
Dinner Knife (SH) 9 5/8" 3 Dz.

FK506
Dessert Spoon 7 1/4" 3 Dz.

FM711
Demitasse Spoon 4 1/2" 3 Dz.

FM721
Cocktail Fork 5 7/8" 3 Dz.

FK528
US Teaspoon 6" 3 Dz.

FK529
Salad/Dessert Fork 7 1/4" 3 Dz.



Rada NEW

BY **abert**

Refined shapes with soft geometric decorations recall traditional values.

FP523
Dinner Fork 8 1/8" 1 Dz.

FP524
Dinner Knife (SH) 9 1/8" 1 Dz.

FP526
Dessert Spoon 5 13/16" 1 Dz.

FP528
Salad/Dessert Fork 7 3/8" 1 Dz.

FP529
Teaspoon 5 1/2" 1 Dz.

FP531
Dinner Spoon 8 3/16" 1 Dz.

FP532
Soup Spoon 5 13/16" 1 Dz.

FP533
Mocca Spoon 4 3/8" 1 Dz.

FP534
Butter Spreader 6 7/8" 1 Dz.

FP661
Fish Fork 7 1/4" 1 Dz.

FP662
Fish Knife 8" 1 Dz.

FP663
Iced Tea Spoon 5 1/2" 1 Dz.





Enrico VIII NEW

BY **abert**

The refined decoration of the edge makes it the right pattern for elegant tables that rely on accessories to enhance their own aesthetic.

FP535
Dinner Fork 8" 1 Dz.

FP536
Dinner Knife (SH) 9 ¼" 1 Dz.

FP537
Dessert Spoon 7 ¾" 1 Dz.

FP538
Salad/Dessert Fork 7 ¼" 1 Dz.

FP539
Teaspoon 5 ¾" 1 Dz.

FP540
Dinner Spoon 8" 1 Dz.

FP541
Soup Spoon 6 ¾" 1 Dz.

FP542
Mocca Spoon 4 ¾" 1 Dz.

FP664
Fish Fork 7 ¼" 1 Dz.

FP665
Fish Knife 7 ½" 1 Dz.



Victory NEW

BY **abert**

An indisputable timeless pattern for any decor.

FP506
Dinner Fork 8 ½" 1 Dz.

FP507
Dinner Knife (SH) 9 ½" 1 Dz.

FP508
Dessert Spoon 7" 1 Dz.

FP509
Salad/Dessert Fork 7 ½" 1 Dz.

FP576
Dessert Knife 8 3/16" 1 Dz.

FP510
Teaspoon 5 ¾" 1 Dz.

FP511
Dinner Spoon 8 ½" 1 Dz.

FP516
Soup Spoon 6 ¾" 1 Dz.

FP517
Mocca Spoon 4 ¾" 1 Dz.

FP519
Butter Spreader 6 ½" 1 Dz.

FP654
Fish Fork 8" 1 Dz.

FP655
Fish Knife 8 ¼" 1 Dz.

FP656
Iced Tea Spoon 8 ½" 1 Dz.





Capitale

BY ARCOROC

Basic, essential and complete. The most common shapes and sizes at a value price point.

FG701
Dinner Fork 8 ¼" 3 Dz.

FG704
Dinner Knife (SH) 9 ¾" 3 Dz.

FG706
Dessert Spoon 7 ½" 3 Dz.

FG709
Soup Spoon 6 ¼" 3 Dz.

FG726
Steak Knife (SH) 9 ¼" 1 Dz.

FG728
US Teaspoon 6 ⅞" 3 Dz.

FG729
Salad/Dessert Fork 7 ½" 3 Dz.



Harrison

BY ARCOROC

Simple yet classic rim pattern is ideal for any casual environment. Coordinates with a multitude of decors and withstands the rigors of fast paced establishments.



FM501
Dinner Fork 7 ⅞" 1 Dz.

FM502
Dinner Spoon 8 ⅞" 1 Dz.

FM504
Dinner Knife (SH) 9 ⅞" 1 Dz.

FM506
Dessert Spoon 7 ⅞" 1 Dz.

FM509
Soup Spoon 6 ⅞" 1 Dz.

FM529
Salad/Dessert Fork 7 ⅞" 1 Dz.

FM505
US Salad Fork 7 ⅞" 1 Dz.

FM528
US Teaspoon 6 ⅞" 1 Dz.

FM518
Iced Teaspoon 7 ½" 1 Dz.

FM530
Euro Dinner Fork 8 ⅞" 1 Dz.





Transitional

Transitional flatware bridges modern and casual styles, offering a harmonious blend of traditional elegance and modern simplicity.



Waterfall NEW	294
Miracle	294
Alessandria	295
Liv	295
Liv Gunmetal	296
Liv II	296
Monaco Satin NEW	297
Harper	297
Harper Satin	298
Luxus Sand	298
Splendido NEW	299
Rinascimento NEW	299
Stone	300
Stone Satin	300
Amber	301
Mikayla	301
Imperial Chopsticks	302



Contains 18% chromium and 10% nickel. 18/10 is the highest quality stainless steel. This stainless is non-magnetic therefore it will not work in flatware retrievers.



Contains 18% chromium and 0% nickel. 18/0 has an economic value which is usually seen at casual and high volume restaurants. This stainless steel is magnetic, therefore, it will work in flatware retrievers



Waterfall

NEW

BY Sola

The textured style is a unique design on this stylish pattern.

FP732
Table Fork 8 ¼" 1 Dz.

FP733
Table Knife (SH) 9 ¾" 1 Dz.

FP739
Tablespoon 8 ¾" 1 Dz.

FP738
Dessert Knife 8 ¾" 1 Dz.

FP735
Dessert/Salad Fork 7 ½" 1 Dz.

FP734
Dessert Spoon 7 ¾" 1 Dz.

FP736
American Teaspoon Spoon 6 ¾" 1 Dz.

FP737
Coffee Spoon 5 ¾" 1 Dz.



Miracle

BY Sola

The honeycomb design hides all imperfections but not the perfect style of this pattern.

SOM04
Table Knife (SH) 9 ¾" 1 Dz.

SOM01
Table Fork 8 ¾" 1 Dz.

SOM02
Tablespoon 8" 1 Dz.

SOM05
Dessert Fork 7 ¼" 1 Dz.

SOM06
Dessert Spoon 7 ¾" 1 Dz.

SOM28
American Teaspoon 6 ¾" 1 Dz.

SOM10
Teaspoon 5 ½" 1 Dz.





Alessandria

BY  Sola

A classic beveled pattern with square handles are complementary to the trendy colors of today's table settings.

MB202
Table Knife (SH) 9 1/4" 1 Dz.

MB203
Dessert Spoon 7 3/8" 1 Dz.

MB201
Table Fork 8" 1 Dz.

MB220
American Teaspoon 6 1/8" 1 Dz.

MB204
Dessert/Salad Fork 7 3/8" 1 Dz.



Liv

BY ARCOROC

A sharp square, straight line tapered handle in a classic design.



FL401
Dinner Fork 8" 1 Dz.

FL409
Soup Spoon 7" 1 Dz.

FL402
Dinner Spoon 8" 1 Dz.

FL418
Iced Teaspoon 6 7/8" 1 Dz.

FL404
Dinner Knife (SH) 9 1/2" 1 Dz.

FL428
US Teaspoon 6 1/2" 1 Dz.

FL406
Dessert Spoon 7 7/8" 1 Dz.

FL429
Salad/Dessert Fork 6 7/8" 1 Dz.



Liv II NEW

BY Chef&Sommelier

This classic square tapered design offers a timeless look to the most eclectic designs and atmospheres.



FP117
Dinner Fork 8" 1 Dz.

FP119
Dinner Knife (SH) 9 ½" 1 Dz.

FP120
Dessert Spoon 7 ¾" 1 Dz.

FP121
Butter Knife 6 ½" 1 Dz.

FP122
Dessert/Salad Fork 6 ¾" 1 Dz.

FP124
Teaspoon 6 ½" 1 Dz.



Liv Gunmetal NEW

BY ARCOROC

Updating our popular Liv pattern in a smokey modern gunmetal finish will bring a classic look with a modern flair to the table.



FP277
Dinner Fork 8" 1 Dz.

FP278
Dinner Knife (SH) 9 ½" 1 Dz.

FP279
Dessert Spoon 7 ¾" 1 Dz.

FP281
Teaspoon 6 ½" 1 Dz.

FP280
Salad/Dessert Fork 6 ¾" 1 Dz.





Monaco Satin NEW

BY **Sola**

Sleek brushed contemporary handles make a dramatic statement for a variety of table settings.

FP725
Table Knife (SH) 9 5/8" 1 Dz.

FP724
Table Fork 8 1/4" 1 Dz.

FP731
Tablespoon 8 1/4" 1 Dz.

FP730
Dessert Knife 7 3/8" 1 Dz.

FP727
Dessert/Salad Fork 7 7/8" 1 Dz.

FP726
Dessert Spoon 7 3/8" 1 Dz.

FP728
American Teaspoon 6 3/8" 1 Dz.

FP729
Coffee Spoon 5 1/2" 1 Dz.



Harper

BY **Chef&Sommelier**

Squared and flared. Subtle impressions give handles a natural appeal.

FL701
Dinner Fork 8 1/8" 3 Dz.

FL702
Dinner Spoon 8 1/2" 3 Dz.

FL704
Dinner Knife (SH) 9 1/2" 3 Dz.

FL706
Dessert Spoon 7 1/2" 3 Dz.

FL709
Soup Spoon 7 1/8" 3 Dz.

FL718
Iced Teaspoon 7 1/4" 3 Dz.

FL711
Demitasse Spoon 4 3/4" 3 Dz.

FL721
Cocktail/Oyster Fork 5 5/8" 3 Dz.

FL727
Butter Spreader 6 3/8" 3 Dz.

FL728
US Teaspoon 6 3/4" 3 Dz.

FL729
Salad Fork 7 3/8" 3 Dz.





Harper Satin

BY Chef&Sommelier

Satin adds a touch of elegance to this squared pattern. Harper is an ideal pattern for hotels as well as trendy upscale restaurants.

FN688
Dinner Fork 8 ½" 3 Dz.

FN689
Dinner Knife (SH) 9 ½" 3 Dz.

FN690
Dinner Spoon 8 ½" 3 Dz.

FN692
Salad Fork 7 ¾" 3 Dz.

FN695
US Teaspoon 6 ¾" 3 Dz.

FN694
Soup Spoon 7 ½" 3 Dz.

FN681
Butter Spreader 6 ¾" 3 Dz.

FN686
Demitasse Spoon 4 ¾" 3 Dz.

FN687
Dessert Spoon 7 ½" 3 Dz.



Luxus Sand

BY Sola

The elegant sand touch at the bottom of the handle is a unique design on this stylish pattern.

SOL04
Table Knife (SH) 9 ½" 1 Dz.

SOL01
Table Fork 8 ¾" 1 Dz.

SOL02
Tablespoon 8 ¾" 1 Dz.

SOL08
Dessert Knife 8" 1 Dz.

SOL05
Dessert Fork 7 ¾" 1 Dz.

SOL06
Dessert Spoon 7 ¾" 1 Dz.

SOL28
American Teaspoon 5 ¼" 1 Dz.

SOL10
Teaspoon 5 ½" 1 Dz.

SOL11
Coffee Spoon 4 ¾" 1 Dz.

SOL20
Cake Fork 6 ¾" 1 Dz.

SOL13
Fish Knife 8 ½" 1 Dz.





Splendido

NEW

BY **abert**

Traditional with a slight transitional flair is the ideal complement for any establishment.

FP543
Dinner Fork 7 7/8" 1 Dz.

FP544
Dinner Knife (SH) 9 5/8" 1 Dz.

FP545
Dessert Spoon 7 1/8" 1 Dz.

FP546
Salad/Dessert Fork 7 1/8" 1 Dz.

FP547
Teaspoon 5 1/2" 1 Dz.

FP548
Dinner Spoon 7 13/16" 1 Dz.

FP549
Soup Spoon 7" 1 Dz.

FP550
Mocca Spoon 4 3/8" 1 Dz.

FP669
Fish Fork 7 7/8" 1 Dz.

FP670
Fish Knife 8 1/2" 1 Dz.

FP671
Butter Spreader 6 3/4" 1 Dz.



Rinascimento

NEW

BY **abert**

This classic hammered pattern glistens and lights up the table bringing life to any setting.

FP487
Dinner Fork 7 7/8" 1 Dz.

FP488
Dinner Knife (SH) 9 1/4" 1 Dz.

FP489
Dessert Spoon 6 13/16" 1 Dz.

FP490
Salad/Dessert Fork 7 1/8" 1 Dz.

FP491
Mocca Spoon 4 1/4" 1 Dz.

FP492
Teaspoon 5 1/4" 1 Dz.

FP493
Soup Spoon 6 11/16" 1 Dz.

FP649
Fish Fork 7 1/2" 1 Dz.

FP650
Fish Knife 8 1/4" 1 Dz.

FP651
Butter Spreader 6 3/4" 1 Dz.



Stone

BY ARCOROC

The hammered texture, medium weight and feel is the perfect complement to dress up your tabletop.

T8001
Dinner Fork 8" 1 Dz.

T8002
Dinner Spoon 8 ½" 1 Dz.

T8004
Dinner Knife (SH) 9 ½" 1 Dz.

T8006
Dessert Spoon 7" 1 Dz.

T8008
Dessert Knife (SH) 8 ¾" 1 Dz.

T8009
Soup Spoon 6 ¾" 1 Dz.

T8011
Demitasse Spoon 4 ¾" 1 Dz.

T8028
US Teaspoon 6" 1 Dz.

T8029
Salad Fork 6 ¾" 1 Dz.



Stone Satin

BY ARCOROC

Our Stone flatware, with a satin finish. Ideal choice for everyday use with lustrous designs.

FM601
Dinner Fork 8" 1 Dz.

FM604
Dinner Knife (SH) 9 ½" 1 Dz.

FM606
Dessert Spoon 7" 1 Dz.

FM609
Soup Spoon 6 ¾" 1 Dz.

FM611
Demitasse Spoon 4 ¾" 1 Dz.

FM627
Butter Spreader 6" 1 Dz.

FM628
US Teaspoon 6" 1 Dz.

FM629
Salad Fork 6 ¾" 1 Dz.





Amber

BY ARCOROC

Sleek outlines surround sanded teardrop handles to create a chic, versatile look that hides fingerprints.

FL601
Dinner Fork 7 7/8" 1 Dz.

FL604
Dinner Knife (SH) 9" 1 Dz.

FL606
Dessert Spoon 7 3/4" 1 Dz.

FL609
Soup Spoon 7 1/8" 1 Dz.

FL628
US Teaspoon 6 3/4" 1 Dz.

FL629
Salad/Dessert Fork 7 1/8" 1 Dz.



Mikayla

BY ARCOROC

Contemporary pieces of art that have bold yet discreet etched handles that mask fingerprint smudges.

FL101
Dinner Fork 8 1/4" 1 Dz.

FL104
Dinner Knife (SH) 9" 1 Dz.

FL106
Dessert Spoon 7 7/8" 1 Dz.

FL109
Soup Spoon 6 7/8" 1 Dz.

FL128
US Teaspoon 6 7/8" 1 Dz.

FL129
Salad/Dessert Fork 7 1/8" 1 Dz.





Imperial Chopsticks

BY  Sola

These sleek chop sticks are the perfect accompaniment for any Asian flair cuisine. The square handles make handling easy.

SCP99

Imperial Chop Sticks 8 ¾" 1 Dz.

SCR98

Universal Chop Stick/ Knife Rest 2 ¾" 1 Dz.



STEAK KNIVES



PAKKAWOOD

An engineered wood/plastic composite material. It creates a genuine wood grain look with better durability and no warping or splitting which is common in real wood.



ACRYLIC

A transparent thermoplastic homopolymer that is dishwasher safe and great for high abrasion resistance.



POM

An engineered thermoplastic material for steak knife handles. A typical application for injection-molded designs.

Steak Knives

BY Chef&Sommelier

IMPERIAL

NEW



FP228
Marble Imperial Steak Knife
Acrylic
9 5/8" 1 Dz.



FJ516
Solid Black Imperial Steak Knife
Acrylic
9 5/8" 1 Dz.



FJ517
Solid Red Imperial Steak Knife
Acrylic
9 5/8" 1 Dz.



FJ507
Brown/Black Imperial Steak Knife
Pakkawood
9 5/8" 1 Dz.



FJ506
Grey Imperial Steak Knife
Pakkawood
9 5/8" 1 Dz.

MARBLE

NEW



FP167
Marble Black Steak Knife
Serrated, Acrylic
9 1/4" 1 Dz.

NEW



FP168
Marble Black Steak Knife
Non-Serrated, Acrylic
9 1/4" 1 Dz.



FMO06
Marble Steak Knife
Serrated, Acrylic
9 1/4" 1 Dz.



FN727
Marble Steak Knife
Non-Serrated, Acrylic
9 1/4" 1 Dz.

REGAL



FJ611
Regal Steak Knife
Rounded Tip, Pakkawood
9 3/8" 1 Dz.



FJ612
Regal Steak Knife
Pointed Tip, Pakkawood
9 3/8" 1 Dz.



FK603
Regal Grey Steak Knife
Pointed Tip, Pakkawood
9 3/8" 1 Dz.



FK307
Elite Steak Knife
Rounded Tip, Pakkawood
10 7/8" 1 Dz.



FJ508
Cherry Royale Steak Knife
Pakkawood
9" 1 Dz.



ESK01
Chelsea Steak Knife
POM
10" 6 Pcs.



FMO26
Black Oak Steak Knife
9 1/2" 3 Dz.



Full collection available on page 271.



T0426
Universal (Lazzo) Steak Knife (SH)
9 1/2" 3 Dz.



Full collection available on page 272.



EQ295
Burlington Steak Knife (SH)
9" 1 Dz.



Full collection available on page 280.

Steak Knives NEW

BY **abert**



FP572
Texas Steak Knife
Razor Edge, Pakkawood
9 ¼" 6 Pcs.



FP571
Angus Steak Knife
Riveted, POM
9" 6 Pcs.



FP575
Modern Steak Knife
Serrated, ABS
9" 1 Dz.



FP574
Fiorentina Stainless Steak Knife
9" 6 Pcs.



FP573
Paleo Pizza Steak Knife
9 ¼" 6 Pcs.

Steak Knives

BY **ARCOROC**



Shown Beverly Steak Knife



ELG01
Beverly Steak Knife
POM
9" 6 Pcs.



FG726
Capitale Steak Knife (HH)
9" 6 Pcs.



Full collection available on page 291.



T1826
Vesca Steak Knife (SH)
9 ¾" 1 Dz.



Full collection available on page 282.

SERVING ACCESSORIES



Lazzo

BY Chef&Sommelier

Essential pieces feature Lazzo's timeless curves and tapered ends.

! Full collection available on page 272.



T0421
Oyster Fork 5 5/8" 3 Dz.



T0422
Sauce Spoon 7 1/4" 1 Dz.



T0418
Iced Tea Spoon 7 1/8" 3 Dz.



T4727
Butter Spreader 6 1/2" 3 Dz.



Living Mirror

BY  Sola

Sleek, specialty items that will complement any collection.

 Full collection available on page 271.



MB304
Cake Fork 6 1/2" 1 Dz.



MB305
Iced Teaspoon 8 1/8" 1 Dz.



MB320
Large Spaghetti Spoon 14 3/4" 1 Dz.



MB309
Cake Server 10 1/8" 1 Dz.



Vesca

BY ARCOROC

Essential serving pieces feature Vesca's simple straightforward design.

 Full collection available on page 282.



T1819
Escargot Fork 5 7/8" 1 Dz.



T1821
Oyster/Cocktail Fork 5 3/8" 1 Dz.



T1816
Serving Fork 10 1/8" 1 Dz.



T1822
Sauce Spoon 7 1/8" 1 Dz.



T1818
Iced Teaspoon 7" 1 Dz.



T1817
Serving Spoon 10 1/8" 1 Dz.



T1824
Sauce Ladle 6 7/8" (1 Oz.) 6 Pcs.



T1825
Soup Ladle 10 7/8" (5 Oz.) 6 Pcs.



T1813
Fish Knife 7 7/8" 1 Dz.







Buffetware







Domino	312
Domino Wood	314
Domino Accessories	316
Mix & Play	318
Cosmo NEW	320
Cosmo Dispensers	322
Cosmo Imperfetto	323
Cosmo On Stage	324
Arcoroc Accessories	324
Serving NEW	325

Domino

Manufactured from powder coated steel which protects from rust and scratches, podiums add different height elevations to the buffet. Available in 3 colors: black, white and copper.

Perfectly matches the Domino Wood frames. See tile options on page 314.





Domino Podium
L: 15 3/4" W: 7 7/8" H: 3 1/2"
1 Pc.

FP034 White
FP032 Black
FP033 Copper

Fits: 2 Tiles



Domino Podium
L: 15 3/4" W: 7 7/8" H: 7 7/8"
1 Pc.

FP037 White
FP035 Black
FP036 Copper

Fits: 2 Tiles



Domino Podium
L: 23 5/8" W: 7 7/8" H: 3 1/2"
1 Pc.

FP040 White
FP038 Black
FP039 Copper

Fits: 3 Tiles



Domino Podium
L: 23 5/8" W: 7 7/8" H: 7 7/8"
1 Pc.

FP043 White
FP041 Black
FP042 Copper

Fits: 3 Tiles



Domino Podium
L: 15 3/4" W: 15 3/4" H: 3 1/2"
1 Pc.

FP046 White
FP044 Black
FP045 Copper

Fits: 4 Tiles



Domino Podium
L: 23 5/8" W: 15 3/4" H: 3 1/2"
1 Pc.

FP049 White
FP047 Black
FP048 Copper

Fits: 6 Tiles



Domino Wood

Domino frames are made in Ash wood, known for being a dense and durable wood featuring meandering grain patterns.

Each frame is stackable which is perfect for doubling up to add elevation on the buffet and for easy storage.

Perfectly matches the Domino Steel frames. See tile options on page 317.





Domino Frame
L: 15 3/4" W: 7 7/8" H: 2"
1 Pc.

FP021 White
FP022 Black

Fits: 2 Tiles or 3-Pitcher Stand



Domino Frame
L: 23 5/8" W: 7 7/8" H: 2"
1 Pc.

FP023 White
FP024 Black

Fits: 3 Tiles, 1 Tile & 3-Pitcher Stand,
or Ice Pack Holder & Cover



Domino Frame
L: 15 3/4" W: 15 3/4" H: 2"
1 Pc.

FP025 White
FP026 Black

Fits: 4 Tiles or Combo of Tiles
& 3-Pitcher Stand



Domino Frame
L: 23 5/8" W: 15 3/4" H: 2"
1 Pc.

FP027 White
FP028 Black

Fits: 6 Tiles or Combo of Tiles
& Ice Pack Holder & Cover or
3-Pitcher Stand





Shown 3 Pitcher Stand, Fluid Carafes, Domino Frame Black, Cosmo On Stage, Dudson Evo Collection

Domino Accessories



FP063
Domino Rectangular Ice Pack
1 Pc.



FP061
3 Pitcher Stand
L: 15 3/4" W: 7 1/8"
1 Pc.
Fits: Domino Wood Frames



FP060
Ice-Pack / Crumb Holder
L: 23 3/8" W: 6 1/4"
1 Pc.
Fits: FP023, FP024, FP027, FP028
Fits: 6 Ice packs



FP058
Ice-Pack Cover Per Thermal Set
L: 22" W: 6 1/4"
1 Pc.



Domino Tiles

Tiles from the Domino collection are made in vitrified porcelain; a material strong, resistant to wear and tear, light and water, oil and grease proof. Mix the various pattern tiles with Domino frames and Domino podiums to create a unique buffet.



FP019
Domino Dark Grey Tile
L: 7 7/8" W: 7 7/8"
25 Pcs.

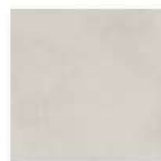

FP018
Domino Light Grey Tile
L: 7 7/8" W: 7 7/8"
25 Pcs.



FP012*
Domino Grey Mix Tile
L: 7 7/8" W: 7 7/8"
25 Pcs.



FP017*
Domino Blue Mix Tile
L: 7 7/8" W: 7 7/8"
25 Pcs.



FP020*
Domino Tan Mix Tile
L: 7 7/8" W: 7 7/8"
25 Pcs.



FP016*
Domino Copper Mix Tile
L: 7 7/8" W: 7 7/8"
25 Pcs.

*Tiles shown are an example of a set. Orders will be a mix of 25 tiles. Designs vary per color. To view more styles visit: ArcCardinal.com



Mix & Play

Mix & Play ready-to-use sets are made from wood with a matte finish aluminum stand. The 3 different structures can be combined together to offer an even larger buffet set.





FP064
 Revolution Set A
 L: 20 5/8" W: 27 1/2" H: 9 1/2"
 1 Pc.



FP065
 Revolution Set B
 L: 20 5/8" W: 27 1/2" H: 8 7/8"
 1 Pc.



FP066
 Revolution Set C
 L: 20 5/8" W: 27 1/2" H: 8 7/8"
 1 Pc.



FP723
 Divider Box - Set B
 L: 13 3/4" W: 7" H: 3 1/4"
 1 Pc.



Cosmo

Modern style 18/10 stainless steel chafing dish that will perfectly match with the rest of the collections. Includes a durable black powder coated steel stand and a removable pan. Can be heated by chafing fuel or the electronic unit included.

With a fixed hinge top and an innovative evaporation system the chafing dish has a thin slot in the lid allowing steam to exit.



FP057
Chafing Dish $\frac{2}{3}$ GN with Black Support
L: 16 $\frac{1}{4}$ " W: 16" H: 10 $\frac{1}{4}$ "
1 Pc.



FP715
Food Pan $\frac{2}{3}$ GN
L: 13 $\frac{1}{2}$ " W: 12 $\frac{1}{2}$ " H: 2 $\frac{1}{2}$ "
1 Pc.



Cosmo Induction NEW

This round 18/10 stainless steel chafing dish will elevate and enhance the buffet presentation at your hotel, restaurant, or catered event. Perfect for keeping vegetables to entrees at ideal serving temperatures. It features a clear glass window that allows guests to see what's inside without having to open the lid. Compatible with induction heating elements, its induction bottom creates an excellent heating surface.



FP381
Steel Round Chafing Dish 5 Qt. (160 Oz.)
L: 13" H: 10"
1 Pc.



FP382
Copper Round Chafing Dish 5 Qt. (160 Oz.)
L: 13" H: 10"
1 Pc.



FP383
Black Round Chafing Dish 5 Qt. (160 Oz.)
L: 13" H: 10"
1 Pc.



FP693
Cosmo Round Food Pan 1/2 Dish
L: 11 3/4" W: 4 3/4" H: 3 1/4"
1 Pc.



FP694
Cosmo Round Food Pan
D: 11 3/4" H: 3 1/4"
1 Pc.

Cosmo Dispensers

Unique by design and functionality, simple clean lines and effortless dispensing will complement any buffet.



FP054
Juice Dispenser (8 L.)
22"
1 Pc.

Juice dispenser made in durable acrylic that offers an exceptional clarity and it can be use with or without the included ice pack to keep drinks cold.



FP055
Coffee Urn (10 L.)
20 1/2"
1 Pc.

Heated by chafing fuel, the coffee urn made in stainless steel is easy to transport due to the two nobs on each side.



FP056
Individual Cereal
Dispenser (3 L.)
20 7/8"
1 Pc.

This cereal dispenser has a rubber paddle which dispenses a controlled portion of cereal or snacks.



FP067
Jam/Honey Dispenser
Base: 13 3/8" x 5" Max: 22 7/8"
1 Pc.

The jam/honey dispenser can be use with the Jambee Nozzle (FP068 - sold separately) to infuse jam or honey into a croissant or muffin and has a disk inside the tube that cleans the walls of the dispenser.



FP068
Jambee Nozzle 18/10
L: 4 1/4"
1 Pc.

Nozzle to be used with Jam & Honey Dispenser (FP067)



FP062
Drip Tray W/ Grill 18/10
L: 6 1/4" W: 6 1/4"
1 Pc.

Optional magnetic drip tray sold separately can be use for the coffee urn and the juice dispenser.

Cosmo Imperfetto

Platters that brings design to the buffet and allows a nice presentation of the food.



FP051
Centerpiece Wood 18/10
D: 12 1/4" H: 2 3/4"
1 Pc.



FP050
Centerpiece Wood 18/10
D: 14 1/8" H: 1 5/8"
1 Pc.



FP052
Centerpiece Wood 18/10
D: 14 1/8" H: 2 3/4"
1 Pc.



FP053
Centerpiece Wood 18/10
D: 16 1/2" H: 2 3/4"
1 Pc.

Cosmo On Stage

On Stage stands made in powder coated stainless steel add elevation to the buffet. The stand can be used with the wood base or replace it with a salad bowl.



FP029
Buffet Stand
L: 11" W: 11" H: 7 7/8"
1 Pc.



FP030
Buffet Stand
L: 11" W: 11" H: 9 7/8"
1 Pc.



FP031
Buffet Stand
L: 11" W: 11" H: 11 3/4"
1 Pc.



FP059
Base Round, Matte Black
W: 7 1/4"
1 Pc.

Arc Cardinal items that fit:
FH289 (Candour)
R0947 (Vintage)
N9362 (Evolutions)



PAIR WITH:

Arcoroc Accessories

Made in 18/10 stainless steel, this bowl is light, resistant and easy to clean. Elevate your buffet display by pairing the bowl with the Cosmo On Stage Stand or serve cold salads on the Domino cooling riser.

ARCOROC



FP274
Stainless Steel Serving Bowl
(3 3/4 Qt. / 110 Oz.) 9 1/2"
1 Pc.



FP275
Stainless Steel Serving Bowl
(5 1/4 Qt. / 174 Oz.) 11"
1 Pc.



Serving NEW

Experience sophistication in your buffet spread with our collection of serving utensils made from high-quality stainless steel. Elevate your presentation with these sleek and durable tools, meticulously designed to bring both style and longevity to your dining buffet. Modern look and versatility will effortlessly enhance your serving experience.



FP496
Pastry Scissor Tongs
18/10 Stainless Steel
8 1/4"
1 Dz.



FP497
Roast Scissor Tongs
18/10 Stainless Steel
9"
1 Dz.



FP498
Roast Tongs
9"
20 Pcs.



FP500
Cake Tongs
9"
20 Pcs.



FP503
Ice Tongs
7 7/8"
2 Dz.



FP505
Salad Tongs
10 1/2"
20 Pcs.





alfi® is a German brand that has been dedicated to making premium carafes for over 100 years. Add a perfect blend of function and elegance to any room.

alfi's European style sits perfectly with our Chef & Sommelier and Dudson designs.

Albergo	328
Gusto Top Therm	330
Hotello	332
Lightweight Carafe	334

Albergo

Classical motif and modern technology;
utilitarian and decorative design that
demonstrates how seemingly contrasting
elements can interact perfectly together.





FN345/ AS2710SS2*
Albergo Top Therm 1.5 L (50 Oz.)
L: 5 3/8" W: 7 3/8" H: 9 1/2"
2 Pcs.



24 HOURS COLD



12 HOURS HOT



SPOUT SYSTEM
CHROME PLATED PLASTIC

TOPTHERM VACUUM STAINLESS STEEL BODY

DURABLE STAINLESS STEEL
INTERIOR AND EXTERIOR

Gusto Top Therm

Gusto TT has an ultra-modern body that is seamlessly integrated within its ultra classic design. With its aesthetics and ergonomics in product design, Gusto has a new comfortable pouring system for easy pouring. Brush finish adds a touch of elegance and prevents finger-print markings.





FN353/ AS2000SS2*
Gusto Top Therm 0.6 L (20 Oz.)
L: 6 1/2" W: 4 1/2" H: 7 1/2"
2 Pcs.



FN352/ AS2010SS2*
Gusto Top Therm 1 L (34 Oz.)
L: 4 9/16" W: 6 1/2" H: 8 19/32"
2 Pcs.



FN351/ AS2020SS2*
Gusto Top Therm 1.5 L (50 Oz.)
L: 5 7/16" W: 6 3/8" H: 10 3/8"
2 Pcs.



FN354/ AS2020SS2COF*
Gusto Top Therm "COFFEE" Imprint
1.5 L (50 Oz.)
L: 5 7/16" W: 6 3/8" H: 10 3/8"
2 Pcs.



FN355/ AS2020SS2DEC*
Gusto Top Therm "DECAF" Imprint
1.5 L (50 Oz.)
L: 5 7/16" W: 6 3/8" H: 10 3/8"
2 Pcs.



FN356/ AS2020SS2HW*
Gusto Top Therm "HOT WATER" Imprint
1.5 L (50 Oz.)
L: 5 7/16" W: 6 3/8" H: 10 3/8"
2 Pcs.



DISHWASHER SAFE



24 HOURS COLD



12 HOURS HOT



SPOUT SYSTEM
CHROME PLATED PLASTIC

TOP THERM VACUUM STAINLESS STEEL BODY

DURABLE STAINLESS STEEL
INTERIOR AND EXTERIOR

Hotello

The first of its kind to be designed specifically for the Hospitality industry.

Hotello was designed with a completely unique sealing system that has no plastic or silicone parts.





FN348/ AS2620SS2*
 Hotello 1 L (34 Oz.)
 L: 4 9/16" W: 5 1/2" H: 8 7/16"
 2 Pcs.



16 HOURS COLD



8 HOURS HOT



DISHWASHER SAFE



— SPECIALLY DEVELOPED HINGED LID
 WITH ONE HAND OPERATION

— TOPTHERM VACUUM STAINLESS STEEL BODY

— DURABLE STAINLESS STEEL
 INTERIOR AND EXTERIOR

Lightweight Carafe

Premium vacuum carafe in a sleek frosted black design adds elegance to beverage service.





COMFORTABLE SPOUT SYSTEM
WITH ONE HAND OPERATION

ALFIDUR VACUUM HARD
GLASS LINER

HIGH QUALITY PLASTIC
WITH FROSTED SURFACE

FN350/ AG2800BK2*
Plastic Black Frosted Surface,
Vacuum Glass Insert 1 L (34 Oz.)
L: 5 3/5" W: 6 1/2" H: 10 4/5"
2 Pcs.



TECHNOLOGY

5 Layers For Improved Insulation:
Alfi 5 layer insulation technology that has silvering on both sides of its space between the glass layers and is equipped with a lasting vacuum. Therefore the carafe maintains the beverage temperature for longer.



24 HOURS COLD



12 HOURS HOT

*alfi SKU, Use for Reference ONLY

ALFI is a registered trademark owned by Alfi GmbH Isoliergefäße, Metall- und Haushaltswaren in the U.S. and other countries.



THERMOS.



PERFORMANCE YOU CAN TRUST
Thermos products deliver what matters everytime.

Brew In Carafe	338
Carafe With Gauge	340
Carafe With Lever	342
Twist And Pour	344
Accessories	346



NSF Certified - Meets Strict NSF Food and Product Safety Standards



Products are dishwasher safe.

Brew In Carafe

Thermos professional Brew In Carafe
with vacuum insulation technology
for maximum temperature retention.



THERMOS.



— DIRECT BREW-IN STOPPER;
FITS UNDER MOST BREWERS

— THERMOS™ VACUUM INSULATION
TECHNOLOGY FOR MAXIMUM
TEMPERATURE RETENTION

— DURABLE TYPE 304 STAINLESS STEEL
INTERIOR AND EXTERIOR

FN371/TGU1900SC6*
NSF Cert. S.S. Brew In Vac. Carafe
1.9 L (64 Oz.)
L: 5" W: 5 3/16" H: 11 3/25"
6 Pcs.

REPLACEMENT ACCESSORIES

 **FN441/ RTGSDC25***
Push Button Decaf Lid for
FN371, FN370, FN357, FN369, FN372
6 Pcs.

 **FN444/ RTGUDC25***
Brew-In Decaf Lid for
FN371, FN372, FN370, FN357, FN369
6 Pcs.

 **FN442/ RTGSG25***
Push Button Tea Lid for
FN371, FN370, FN357, FN369, FN372
6 Pcs.

 **FN445/ RTGUG25***
Brew-In Tea Lid for
FN371, FN372, FN370, FN357, FN369
6 Pcs.

 **FN443/ RTGSL25***
Push Button Coffee/ Hot Water Lid for
FN371, FN370, FN357, FN369, FN372
6 Pcs.

 **FN446/ RTGUL25***
Brew-In Coffee/ Hot Water Lid for
FN371, FN372, FN370, FN357, FN369
6 Pcs.



*Thermos SKU, Use for Reference ONLY

THERMOS is a registered trademark in over 115 countries.

Carafe With Gauge

Brewer carafe with fresh zone stopper and gauge fits under most brewers. Thermos vacuum insulation technology for maximum temperature retention.



FN372/ THF19SCLG4MD*
NSF Cert. S.S. Vac. Carafe with Gauge
1.9 L (64 Oz.)
L: 7" W: 8 1/2" H: 7 1/2"
4 Pcs.

REPLACEMENT ACCESSORIES



FN441/ RTGSDC25*
Push Button Decaf Lid for
FN370, FN357, FN369, FN372
6 Pcs.



FN444/ RTGUDC25*
Brew-In Decaf Lid for
FN371, FN372, FN370, FN357, FN369
6 Pcs.



FN442/ RTGSG25*
Push Button Tea Lid for
FN370, FN357, FN369, FN372
6 Pcs.



FN445/ RTGUG25*
Brew-In Tea Lid for
FN371, FN372, FN370, FN357, FN369
6 Pcs.



FN443/ RTGSL25*
Push Button Coffee/ Hot Water Lid for
FN370, FN357, FN369, FN372
6 Pcs.



FN446/ RTGUL25*
Brew-In Coffee/ Hot Water Lid for
FN371, FN372, FN370, FN357, FN369
6 Pcs.



FN373/ THF0208*
Fresh Zone Stopper with Gauge
with Care and Use and Brush for FN372
10 Pcs.



DIRECT BREW-IN FRESH ZONE STOPPER; FITS UNDER MOST BREWERS

THE STOPPER FEATURES A CONVENIENT DIAL TO MARK THE BREWING TIME AND A VALVE TO TELL HOW FULL IS THE CARAFE

THERMOS™ VACUUM INSULATION TECHNOLOGY FOR MAXIMUM TEMPERATURE RETENTION

ERGONOMICALLY DESIGNED "OPEN HANDLE" FOR MANY POURING POSITIONS

LIGHTWEIGHT AND EASY TO CARRY

EXTERIOR STAYS COOL TO THE TOUCH WITH HOT CONTENTS AND SWEAT-PROOF WITH COLD

DURABLE TYPE 304 STAINLESS STEEL INTERIOR AND EXTERIOR



*Thermos SKU, Use for Reference ONLY

THERMOS is a registered trademark in over 115 countries.

Carafe With Lever

Designed for professional everyday use. Features a lever-operated stopper and a double wall stainless steel body to help keep coffee or tea at the perfect temperature.



- LEVER OPERATED ONE- PUSH STOPPER
- THERMOS™ VACUUM INSULATION TECHNOLOGY FOR MAXIMUM TEMPERATURE RETENTION
- FINGER PRINT RESISTANT CLEAR EXTERIOR FINISH
- DURABLE TYPE 304 STAINLESS STEEL INTERIOR AND EXTERIOR



FN370/ TGS155C*
NSF Cert. S.S. Push Button Vac. Carafe
1.5 L (50 Oz.)
L: 5" W: 6 3/8" H: 10"
6 Pcs.

 
20 HOURS HOT 24 HOURS COLD



FN357/ TGS105C*
NSF Cert. S.S. Push Button Vac. Carafe
1 L (34 Oz.)
L: 5" W: 6 3/8" H: 7 9/16"
6 Pcs.

 
14 HOURS HOT 24 HOURS COLD



FN369/ TGS065C*
NSF Cert. S.S. Push Button Vac. Carafe
0.6 L (20 Oz.)
L: 5" W: 6 3/8" H: 6 1/2"
6 Pcs.

 
9 HOURS HOT 22 HOURS COLD

REPLACEMENT ACCESSORIES



FN441/ RTGSDC25*
Push Button Decaf Lid for
FN370, FN357, FN369, FN372
6 Pcs.



FN444/ RTGUDC25*
Brew-In Decaf Lid for
FN371, FN372, FN370, FN357, FN369
6 Pcs.



FN442/ RTGSG25*
Push Button Tea Lid for
FN370, FN357, FN369, FN372
6 Pcs.



FN445/ RTGUG25*
Brew-In Tea Lid for
FN371, FN372, FN370, FN357, FN369
6 Pcs.



FN443/ RTGSL25*
Push Button Coffee/ Hot Water Lid for
FN370, FN357, FN369, FN372
6 Pcs.



FN446/ RTGUL25*
Brew-In Coffee/ Hot Water Lid for
FN371, FN372, FN370, FN357, FN369
6 Pcs.



* Thermos SKU, Use for Reference ONLY

THERMOS is a registered trademark in over 115 countries.

Twist And Pour

Allows for cold storage of dairy products* and hot drinks by the coffee station. Sturdy ergonomic and lightweight designed handle for easy pouring. Double silicone gasket on lid minimizes spills and helps with temperature retention.

*See Care & Use for Details



LID HAS DOUBLE SILICONE GASKET TO MINIMIZE SPILLS AND ASSISTS IN TEMPERATURE RETENTION

THERMOS™ VACUUM INSULATION TECHNOLOGY FOR MAXIMUM TEMPERATURE RETENTION

DURABLE TYPE 304 STAINLESS STEEL INTERIOR AND EXTERIOR



FN361/TGB065C*
NSF Cert. S.S. Vac. Carafe Twist/Pour
0.6 L (20 Oz.)
L: 4" W: 5 1/2" H: 8 3/8"
6 Pcs.

 16 HOURS HOT
 24 HOURS COLD



FN368/TGM105C*
NSF Cert. S.S. Vac. Carafe Twist/Pour
1 L (34 Oz.)
L: 4 1/2" W: 6 3/8" H: 10 3/8"
6 Pcs.

 22 HOURS HOT
 24 HOURS COLD



FN362/TGB105C*
NSF Cert. S.S. Vac. Carafe Twist/Pour
0.9 L (32 Oz.)
L: 4 1/2" W: 5 1/2" H: 11 3/8"
6 Pcs.

 24 HOURS HOT
 24 HOURS COLD



FN363/ TGB10SCHH6*
NSF Cert. S.S. Vac. Carafe Twist/Pour
"HALF & HALF" Imprint
0.9 L (32 Oz.)
L: 4 ½" W: 5 ½" H: 11 ¾"
6 Pcs.



FN364/ TGB10SCCR6*
NSF Cert. S.S. Vac. Carafe Twist/Pour
"CREAM" Imprint
0.9 L (32 Oz.)
L: 4 ½" W: 5 ½" H: 11 ¾"
6 Pcs.



FN365/ TGB10SCLF6*
NSF Cert. S.S. Vac. Carafe Twist/Pour
"LOW FAT" Imprint
0.9 L (32 Oz.)
L: 4 ½" W: 5 ½" H: 11 ¾"
6 Pcs.



FN366/ TGB10SCML6*
NSF Cert. S.S. Vac. Carafe Twist/Pour
"MILK" Imprint
0.9 L (32 Oz.)
L: 4 ½" W: 5 ½" H: 11 ¾"
6 Pcs.



FN367/ TGB10SCSK6*
NSF Cert. S.S. Vac. Carafe Twist/Pour
"SKIM" Imprint
0.9 L (32 Oz.)
L: 4 ½" W: 5 ½" H: 11 ¾"
6 Pcs.



FP763
NSF Cert. S.S. Vac. Carafe Twist/Pour
"OAT" Imprint
0.9 L (32 Oz.)
L: 4 ½" W: 5 ½" H: 11 ¾"
6 Pcs.



FP762
NSF Cert. S.S. Vac. Carafe Twist/Pour
"SOY" Imprint
0.9 L (32 Oz.)
L: 4 ½" W: 5 ½" H: 11 ¾"
6 Pcs.



FP764
NSF Cert. S.S. Vac. Carafe Twist/Pour
"ALMOND" Imprint
0.9 L (32 Oz.)
L: 4 ½" W: 5 ½" H: 11 ¾"
6 Pcs.



* Thermos SKU, Use for Reference ONLY
THERMOS is a registered trademark in over 115 countries.





FN441/ RTGSDC25*
Push Button Decaf Lid for
FN370, FN357, FN369, FN372
6 Pcs.



FN442/ RTGSG25*
Push Button Tea Lid for
FN370, FN357, FN369, FN372
6 Pcs.



FN443/ RTGSL25*
Push Button Coffee/ Hot Water Lid
for FN370, FN357, FN369, FN372
6 Pcs.



FN444/ RTGUDC25*
Brew-In Decaf Lid for
FN371, FN372, FN370, FN357, FN369
6 Pcs.



FN445/ RTGUG25*
Brew-In Tea Lid for
FN371, FN372, FN370, FN357, FN369
6 Pcs.



FN446/ RTGUL25*
Brew-In Coffee/ Hot Water Lid for
FN371, FN372, FN370, FN357, FN369
6 Pcs.



FN447/ TGB900525*
Replacement TGB Stopper for
FN361, FN363, FN364, FN365,
FN366, FN367, FN362
6 Pcs.



FN448/ TGM1005125*
Replacement Stopper for FN368
6 Pcs.



FN373/ THF0208*
Fresh Zone Stopper with Gauge
Care and Use and Brush for FN372
10 Pcs.





The Chasseur brand has obtained the "Guaranteed Made in France" certification; the only certification that guarantees that a product has been made in France.

Round & Oval Casserole	350
Round & Oval Low Casserole	352
Terrine Rectangle Gratin	354
Round & Oval Dish	356
Trivets	357

COMPATIBLE WITH ALL HEAT SOURCES



*If using induction, heat slow. Do not use hot boost.



Round & Oval Casserole

Cast iron is compatible with all heat sources including induction which makes the perfect presentation for any buffet. It makes a dramatic statement with its stylish look and trendy colors as well as retaining its heat while serving up favorite buffet items.





Mini Round Casserole
0.37 Q (12 Oz.) 3 1/4" (10 cm)
1 Pc.

FN421 Matte Black
FN422 Red



Mini Round Casserole
0.63 Q (20 Oz.) 4 3/4" (12 cm)
1 Pc.

FN423 Matte Black
FN424 Red



Round Casserole
4.23 Q (135 Oz.) 9 1/2" (24 cm)
1 Pc.

FN425 Matte Black
FN426 Red



Round Casserole
6.44 Q (206 Oz.) 11" (28 cm)
1 Pc.

FN427 Matte Black
FN428 Red



 Chasseur on your buffet: Lid can be propped up using the side handle.





Round & Oval Low Casserole



The round and oval low casseroles are the ultimate multi-use pan. The stylish lidded casserole is perfect for creating one dish meals and the perfect vessels for sides such as risotto and roasted vegetables.



FN437
Round Serving Matte Black Casserole
1.8 Q (57.6 Oz.) 9 1/2" (24 cm)
1 Pc.



FN438
Round Serving Ruby Casserole
1.8 Q (57.6 Oz.) 9 1/2" (24 cm)
1 Pc.



FN432
Oval Matte Black Casserole
4.23 Q (135.25 Oz.) 10 5/8" (27 cm)
1 Pc.



FN433
Oval Ruby Casserole
4.23 Q (135.25 Oz.) 10 5/8" (27 cm)
1 Pc.



FN431
Oval Matte Black Casserole
6.34 Q (202.88 Oz.) 12 1/4" (31 cm)
1 Pc.

Terrine, Rectangle & Gratin

The rectangular and gratin dishes make perfect casseroles and lasagnas. This multi-use item can serve as trendy vessels to serve desserts in like creme bruleé. The two terrine sizes are not only essential for slowly cooking pâtés but make great pans for meatloafs and small casseroles.





FN429
 Rectangular Matte Black Terrine
 1.06 Q (34 Oz.)
 In: 9 7/8" x 3 3/8" (25 cm)
 Out: 12 1/4" x 4 3/8"
 1 Pc.



FN430
 Rectangular Matte Black Terrine
 1.25 Q (40.5 Oz.)
 In: 11 3/8" x 3 3/8" (27 cm)
 Out: 13 7/8" x 4 1/4"
 1 Pc.



FN435
 Rectangular Matte Black Baking Dish
 0.75 Q (23.66 Oz.)
 In: 8 7/8" x 5 1/8" (22 1/2 cm)
 Out: 10 3/4" x 5 1/2"
 1 Pc.



FN436
 Gratin Matte Black Baking Dish
 2.12 Q (68 Oz.)
 In: 11 1/2" x 8" (29 cm)
 Out: 12 13/16" x 8 1/4"
 1 Pc.



FN434
 Gratin Matte Black Baking Dish
 0.95 Q (30.5 Oz.)
 In: 7 1/2" x 4 11/16" (18 1/2 cm)
 Out: 9 1/8" x 4 13/16"
 1 Pc.



Round & Oval Dish

Enameled cast iron is perfect for sautéing, roasting and stewing – it warms gradually, heats evenly and retains heat for a long time.





FN417
Round Matte Black Dish (17 Oz.)
In: 5 7/8" (15 cm) Out: 7 3/8"
1 Pc.



FN418
Round Matte Black Dish (24 Oz.)
In: 6 3/4" (18 cm) Out: 8 1/2"
1 Pc.



FN419
Oval Matte Black Dish (17 Oz.)
In: 7 7/8" x 5 3/4" (20 cm)
Out: 10" x 5 7/8"
1 Pc.



FN420
Oval Matte Black Dish (12 Oz.)
In: 11" x 7 7/8" (28 cm)
Out: 13 3/8" x 8 1/8"
1 Pc.



PAIR WITH: *Trivets* **NEW**

See Page 378 for more products that fit Trivets



FN976
Round Trivet 8 1/2"
6 Pcs.
Fits: FN421, FN422,
FN423, FN424



FN977
Oval Trivet
L: 10 1/2" W: 8"
6 Pcs.
Fits: FN417, FN418



FN978
Oval Trivet
L: 11 3/4" W: 7"
6 Pcs.
Fits: FN419

ARCOROC





Shown Tempo Lamp White



Accessories



Shown Tempo Mini Sage

NEW

Tempo Lamps	362
Tempo Mini Lamps	364
Saturno Lamps	365
Lamp Charging	365
Art & Table	366
Serving	367
Wine & Bar	368
ARCOROC	
Ash Trays & Votive	370



Tempo NEW

Tempo is a rechargeable LED lamp that features a warm light, capable of creating refined atmospheres in each environment, from the lounge to the restaurant.

The design combines elegance and simplicity. It is a high-quality lamp, made of durable and recyclable materials: die-cast aluminum and extruded aluminum.

The lamp features a touch-sensitive button that not only turns it on and off but also allows you to effortlessly adjust the brightness of the light.





FP349
Tempo Lamp Charcoal
4" x 4" x 11"
1 Pc.



FP350
Tempo Lamp Copper
4" x 4" x 11"
1 Pc.



FP351
Tempo Lamp White
4" x 4" x 11"
1 Pc.



Tempo Mini NEW

The best of the Tempo lamp now in a mini version. Perfect for smaller spaces or an elegant cozy touch to your space.



Shown Tempo Mini Sage



FP431
Tempo Lamp Mini Charcoal
4" x 4" x 7 7/8"
1 Pc.



FP432
Tempo Lamp Mini Copper
4" x 4" x 7 7/8"
1 Pc.



FP433
Tempo Lamp Mini White
4" x 4" x 7 7/8"
1 Pc.



FP461
Tempo Lamp Mini Sand
4" x 4" x 7 7/8"
1 Pc.



FP460
Tempo Lamp Mini Sage
4" x 4" x 7 7/8"
1 Pc.



Shown Saturno White

abert

Saturno NEW

Featuring a warm and cool light option Saturno is the cousin to the Tempo Lamp. Saturno offers sleek vertical lines for a modern and contemporary look.



FP462
Lamp White
4 3/8" x 4 3/8" x 11 1/2"
1 Pc.



FP463
Lamp Black
4 3/8" x 4 3/8" x 11 1/2"
1 Pc.



Lamp Charging NEW

Charge 6 lamps at a time. The base comes with 4 poles to be able to stack another charging base (second base sold separately). Fits: Tempo, Tempo Mini and Saturno lamps



FP430
6 Lamp Charger Tray
21 5/8" x 14 1/8" x 1 3/4"
1 Pc.



(2) FP430 trays can be stacked to create more charging space.
**Second base sold separately.*

Art & Table NEW

Explore our selection of 18/10 stainless steel table accessories for an elevated dining experience. These durable and elegant additions are designed to complement your style and enhance your table presentations.



Shown Bread Basket with Faux Leather Handle (45 Oz.)



FP512
Supreme Outside Base Cup 18/10
5 1/8" x 5 1/8" x 3"
1 Dz.



FP513
Supreme Cup 18/10
5 1/8" x 5 1/8" x 3 3/8"
1 Dz.



FP514
Multipurpose Tray 18/10
9 1/2" x 3 3/4"
6 Pcs.



FP471
3 Tier Petit Four Stand 18/10
8 3/8" x 8 3/8" x 12 1/4"
1 Pc.



FP472
Bread Basket
with Faux Leather Handle 18/10
(28 Oz.)
7" x 7" x 1 1/2"
1 Pc.



FP699
Bread Basket
with Faux Leather Handle 18/10
(45 Oz.)
9" x 9" x 2"
1 Pc.



Shown Oval Platter (19 3/4" x 13 3/4")

Serving NEW

Discover our professional-grade stainless steel platters and trays, perfect for elevating the dining experience in hotels and restaurants. Designed for durability and style, these versatile pieces enhance presentations, ensuring a sophisticated touch for your establishment.



Oval Platter without Rim 18/10

FP515
15 3/4" x 10 5/8"
6 Pcs.

FP518
17 3/4" x 12 1/4"
6 Pcs.

FP520
19 3/4" x 13 3/4"
6 Pcs.



FP527
Buffet/Bar Tray 18/10
13 3/4" x 4"
1 Dz.



FP530
Pastry/Bar Tray 18/10
9 7/8" x 7 7/8"
1 Dz.



FP522
Large Pastry/Bar Tray 18/10
23 5/8" x 4"
1 Dz.



FP525
Large Buffet/Bar Tray 18/10
23 5/8" x 7 7/8"
1 Dz.



Wine & Bar NEW

Discover sophistication and functionality with our 18/10 stainless steel ice buckets and stands collection. Take your hosting experience to another level with these sleek and durable essentials, crafted to keep your beverages perfectly chilled.



FP521
Modern Champagne Bucket
9 1/2" x 9 1/2" x 8 3/8" (6.5 Qt. / 210 Oz.)
6 Pcs.



FP473
Modern Champagne Bucket
Round Stand
10 1/4" x 10 1/4" x 22 1/2"
1 Pc.



FP700
Champagne Bucket
with Faux Leather Handle (5 Qt.)
7 1/2" x 7 1/4"
1 Pc.



FP476
Stainless Steel Ice Bucket
with Lid
5 3/8" x 5 3/8" x 7 1/8"
1 Pc.

Ash Trays & Votive

Complete your bar top experience with a votive candle holder that creates tailored experience. Also, provide your customers with a convenient ashtray, keeping your grounds clean.



C1320 •
Clear
H: 1 3/8" T: 4 1/4"
B: 3 1/2" M: 4 1/4"
2 Dz.



51257 •
Clear
H: 1 1/4" T: 3 1/4"
B: 2 7/8" M: 3 1/4"
2 Dz.



00187 •
Black
H: 1 3/8" T: 4 1/4"
B: 3 1/2" M: 4 1/4"
2 Dz.



55878 •
Black
H: 1 1/4" T: 3 1/4"
B: 2 7/8" M: 3 1/4"
2 Dz.



J3811
Votive (3 Oz.)
H: 2 1/2" T: 1 1/16"
B: 2" M: 2"
3 Dz.



Custom Decorated Glassware

Custom Decorated Glassware is a great way to increase the perceived value of a visit to your establishment—and to stand out from the competition.

Decorated glass draws attention to your beverage selections. If combined with a take home program, it is an especially effective marketing method.

It is the perfect way to control the pour*, which translates to significant cost savings.

*Pour lines are approximate and should not be used as an exact measurement.

Contact your Arc Cardinal Consultant to find out how to customize your glassware.



Take Advantage of our Stocked Decorated Items



D1CM5312
Excalibur Vin with pour line (12 Oz.)
H: 7 1/2" T: 3" B: 3" M: 3 3/8"
2 Dz.

Approximate Pour Lines:
(6 Oz.) Bottom of Vin
(8 Oz.) Top of Vin



L0571
Cabernet Tall Wine with pour line (16 Oz.)
H: 8 3/8" T: 2 3/4" B: 3" M: 3 1/2"
2 Dz.

Approximate Pour Lines:
(6 Oz.) Bottom of Grapes
(9 Oz.) Top of Grapes



Q1069
Sequence Corkscrew Universal (16 Oz.)
H: 9" T: 2 3/8" B: 3 1/4" M: 3 3/8"
1 Dz.

Approximate Pour Lines:
(6 Oz.) Bottom of Corkscrew
(9 Oz.) Top of Corkscrew

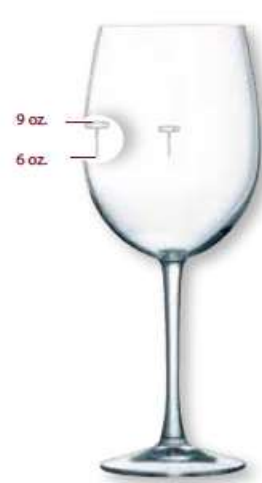

V2128
Romeo Corkscrew Wine (16 Oz.)
H: 8 3/8" T: 2 7/8" B: 3" M: 3 3/8"
1 Dz.

Approximate Pour Lines:
(6 Oz.) Bottom of Corkscrew
(9 Oz.) Top of Corkscrew

Custom Decorated Dinnerware

All of our white ceramic dinnerware patterns can be decorated. With wide options, including but not limited to, banding (shown), logos can also be applied in the well or around the rim. The choices are endless!

Minimum Order Quantity 12 Dz. All pieces are custom and made to order. For more information on customizing your dinnerware, contact your Arc Cardinal Consultant.



GOLD RIM

SILVER RIM



GREEN RIM

RED RIM

Laser Decoration & Etching

Laser etching is great option for a variety of products to showcase your brand in a subtle and sophisticated way. From drinkware, barware, dinnerware and flatware there is wide variety of pieces to choose from.

Minimum Order Quantity 24 Dz. All pieces are custom and made to order. For more information contact your Arc Cardinal Consultant.

FLATWARE AND STEAK KNIFE*

Not all flatware patterns can be decorated due to surface and/or handle, please inquire about specific patterns. Mirror flatware patterns are available for handle sand or satin finishing.



LASER INTO THE BLADE

LASER W/ BLACK FILL

DRINKWARE, BARWARE, & DINNERWARE

Not all flatware patterns can be decorated due to surface and/or handle, please inquire about specific patterns. Mirror flatware patterns are available for handle sand or satin finishing.



ETCHED DECORATION

LASER DECORATION

Acacia Wood Reference



*HAND WASH ONLY



FN282*
Acacia Wood MD Rectangle Handled Board
L: 18 1/4" W: 4 3/4"
4 Pcs.



FN283*
Acacia Wood LG Rectangle Handled Board
L: 21 1/2" W: 5 1/2"
4 Pcs.



FN284*
Acacia Wood Square Handled Board
L: 14 7/8" W: 10"
4 Pcs.

COMPATIBLE GLASSWARE & DINNERWARE

with Acacia Wood boards:

INNER CIRCLE 2" - 2 1/8"

G3658 Cabernet Hi Ball (7 3/4 Oz.)

U1032 Open Up Warm Tumbler (10 Oz.)

G3322 Primary DOF (12 Oz.)

G3368 Lima Hi Ball (12 3/4 Oz.)

N0834 Macaron Rocks (13 1/2 Oz.)

G3323 Primary Beverage (14 3/4 Oz.)

FM559 Eternity Plus Apex Mug (12 Oz.)

FM537 Eternity Plus Bouillion/ Sugar (7 3/4 Oz.)

V5927 Shetland Hi Ball (12 Oz.)

C8303 Perfection Tumbler (15 Oz.)

J4094 Gotham Rocks (4 1/2 Oz.)

P6284 Perfection Tumbler (12 Oz.)

FM120 Outdoor Perfect Stemless Wine (15 Oz.)

R0741 Appetizer Deep Bowl (5 Oz.)

Chef&Sommelier

ARCOROC

OUTER CIRCLE 3 5/8" **

L3963 Fluid Carafe (16 3/4 Oz.)

L5636** Sequence Burgundy (20 1/2 Oz.)

L5637** Sequence Bordeaux (26 Oz.)

FJ035** Cabernet Bordeaux (21 1/4 Oz.)

**For Added Stability, Place Glass Once On Table

Chef&Sommelier

Glassware Care & Handling

Elegant dinnerware, shining cutlery, fresh linens and sparkling glassware make an impression on your customers that is almost as important as what is on your menu. As such, high-quality tableware is a big investment — protecting and maintaining this investment is essential to the success of your operation.

Thermal shock (sudden temperature change causing stress and often resulting in breakage) and mechanical shock (impact causing chipping, cracking, or breakage) are the primary factors affecting the life cycle of glassware.

Food service glassware absorbs thermal and mechanical shocks on a daily basis. Eventually, it will give in to the buildup of these shocks, and breakage will occur. If your glassware shows the wear and tear of rigorous use, it should be retired — before it can break in-service or otherwise affect your customers' opinion of your operation.

GLASSWARE DO'S

ALWAYS separate glassware, dinnerware and flatware bus tubs.



ALWAYS use an ice scoop to fill glasses with ice



ALWAYS stack items specially marked as stackable



ALWAYS allow freshly washed glasses to return to room temperature before going back into service



ALWAYS preheat glasses used for warm drinks with warm water.



ALWAYS remove chipped or cracked glassware from service for safety reasons.



ALWAYS load glassware into a plastic storage rack.



ALWAYS use the proper racks for each glass.

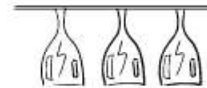

ALWAYS remove ice and beverage before placing glass in bus tub to allow the glass to return to room temperature before dishwashing (to avoid thermal shock).



ALWAYS keep the proper amount of par levels for the operation.

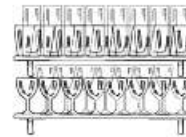

GLASSWARE DONT'S

NEVER mix glassware, dinnerware and flatware in the same bus tub.



NEVER scoop ice with glasses.



NEVER stack glasses that are not marked stackable.



NEVER use dishwasher warm glass for serving cold beverages

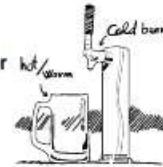

NEVER have glass to glass contact—avoid picking more than 1 glass up at once.



NEVER put flatware into glasses.



NEVER allow the glass to make contact with the beer tap.



NEVER allow glassware to remain soiled overnight or for long periods (max 2 hours).



Dinnerware Care & Handling

Food service dinnerware handles a heavy workload — and while Arc Cardinal builds dinnerware for such usage, there are some simple steps that can be taken to significantly prolong the life and look of these products. The following guidelines cover various troubleshooting and maintenance ideas that are applicable to all types of dinnerware.

DINNERWARE DO'S

ALWAYS use a plastic scraper, sink sprayer or gloved hand to remove stubborn food.



ALWAYS use proper dish racks for plates and hollowware items during dish washing.



ALWAYS separate dinnerware from glassware and flatware in bus buckets.

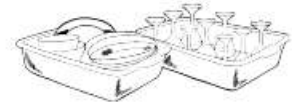

ALWAYS have your commercial dishwasher serviced regularly to ensure proper water balance and rinse aid.



ALWAYS allow dinnerware to cool after dishwashing to room temperature and thoroughly dry before storing or putting back in service.

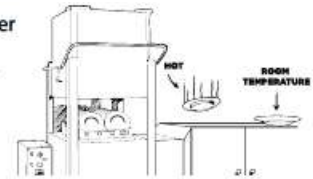

DINNERWARE DONT'S

NEVER use metal pads, steel wool or abrasive cleaners.



NEVER stack dishes more than 1 ft. high.



NEVER overload bus buckets.



NEVER bang dinnerware on waste can or warewashing table to avoid chipping and damage to dinnerware.



NEVER leave soiled dinnerware overnight to avoid staining of surfaces from certain beverages and sauces.



ARC CARDINAL FIVE-YEAR EDGE CHIP WARRANTY

Select Chef & Sommelier and Arcoroc collections offer a five-year edge chip warranty as standard on ALL pieces within the collections – including the squares, rectangles and cups – yes, everything. (Conditions available upon request.)

Flatware Care & Handling

Strict adherences to specifications and stringent quality controls at each stage of production make Chef & Sommelier, Abert, Sola and Arcoroc flatware resistant and reliable. We meticulously scrutinize our items to ensure they are of the correct gauge, an important guarantee of durability.

Arc Cardinal offers flatware made from 18/10 stainless steel and is designed to withstand intensive use and industrial dishwasher conditions. Whether classic or modern, you will find the Chef & Sommelier, Abert, Sola, or Arcoroc pattern that fits your needs in terms of aesthetics and user requirements. For your peace of mind, our 18/10 products come with a 10-year guarantee, applicable in case of any defect in the materials or production. This guarantee is only valid if all recommendations for use (listed below) are followed. Damage due to normal wear and tear, an accident, improper use, excessive use of detergents or use of non-compliant detergents is not covered by this guarantee. This does not cover discoloration, scratching or staining.

FLATWARE DO'S

ALWAYS separate flatware from other items in the bus tray.

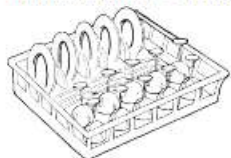

ALWAYS rinse flatware after use before loading in the dishwasher.

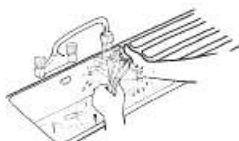

ALWAYS empty dishwasher immediately after completion of cycle and dry flatware with a soft cloth.



ALWAYS store flatware in a dry place.



ALWAYS use the proper flatware racks for ware-washing to encourage water to dry/drain quickly and minimize scratching.

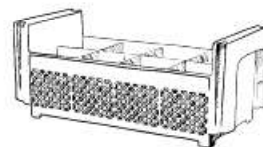

FLATWARE DONT'S

NEVER use detergent with lemon or other citrus added.



NEVER wash silver and stainless together to avoid discoloration.



NEVER use silver cleaner to wash stainless.



NEVER use flatware for cooking as intense heat could damage the flatware.



Glassware Par Levels

To calculate standard usage quantities for your establishment, select the appropriate type of operation, and then simply multiply the number of seats by the number listed below.

Example:

125 Seat Fine Dining Restaurant x 11 Oz. Water (3) = 375 Glass recommended order quantity.

200 Seat Banquet x 8 ½ Oz. Wine (1 ½) = 300 Glass recommended order quantity.

100 Seat Upscale Casual Restaurant x 12 Oz. Iced Tea (1 ½) = 150 recommended glass order quantity.

Item	Segment		
	Fine Dining	Casual Upscale	Banquet
Old Fashioned / Rocks 8 ½ Oz.	3	3	2
Double Rocks / DOF 10 ½ - 14 Oz.	3	3	2
Beverage 12 ½ Oz.	3	3	2
Beer 16 Oz.	2	2	2
Wine 8 ½ Oz.	2	3	2
Flute 6 Oz.	2	3	2
Cocktail 7 ½ Oz.	1 ½	2	1 ½
Cocktail 10 Oz.	1 ½	2	1 ½
Margarita 12 - 14 Oz.	1 ½	1 ½	1 ½
Shot 1 ¼ Oz.	1 ½	1 ½	1 ½
Cordial 4 Oz.	1 ½	1 ½	1 ½
Juice 5 - 6 Oz.	1 ½	1 ½	1 ½
Water / All Purpose 11 - 14 Oz.	3	3	3
Iced Tea 12 - 16 Oz.	1 ½	1 ½	1 ½
Wine 16 - 20 Oz.	1	1	1
Flute 5 ¾ Oz.	2	3	3

Flatware Par Levels

To calculate standard usage quantities for your establishment, select the appropriate type of operation, and then simply multiply the number of seats by the number listed below.

Example:

125 Seat Fine Dining Restaurant x Teaspoon (5) = 625 Teaspoon recommended order quantity.

100 Seat Fine Dining Restaurant x Iced Tea Spoon (1 ½) = 150 Iced Tea Spoon recommended order quantity.

200 Seat Upscale Casual Restaurant x Dinner Knife (2) = 400 Dinner Knife recommended order quantity.

Item	Segment		
	Fine Dining	Upscale Casual	Catering
Teaspoon	4	3	3
Dessert or Soup Spoon	2	2	3
Tablespoon	¼	¼	-
Iced Teaspoon	1 ½	1	-
Demitasse Spoon	2	1	2
Utility/Dessert Fork	2	1 ½	2
Dinner Fork	2	2	3
Oyster or Cocktail Fork	2	1	1 ½
Dinner Knife (SH)	2	2	3
Utility/Dessert Knife	2	1 ½	2
B&B Knife or Butter Spreader	2	2	3

Dinnerware Par Levels

To calculate standard usage quantities for your establishment, select the appropriate type of operation, and then simply multiply the number of seats by the number listed below.

Example:

125 Seat Fine Dining Restaurant x 10 ¼" – 10 ⅜" Dinner Plate (2) = 250 Plate recommended order quantity.

100 Seat Fine Dining Restaurant x Coffee/Tea Cup (3) = 300 Cup recommended order quantity.

200 Seat Upscale Casual Restaurant x 5 ½" – 6 ⅝" Bread Plate (2) = 400 Plate recommended order quantity.

Item	Segment			
	Fine Dining	Upscale Casual	Catering	Banquet
Bread & Butter Plates	2	2	2	6
Salad/ Dessert Plates	2	2	2	-
Lunch Plate	2	2	2	2
Dinner Plate 9 ¾" - 10"	3	1 ½	1 ½	2
Dinner Plate 10 ¼" – 10 ⅜"	2	2	2	-
Platters 7 ¼" – 9 ⅞"	1 ½	1	1	-
Platters 11" - 15"	1 ½	1	1	1 ½
Coffee/Tea Cup	3	3	2	2
Bouillon, Handled or Non-handled	1	1 ½	1 ½	1 ½
Mug	2	2	2	2
Saucers	3	3	2	2
Fruit Dish	3	2	2 ½	6
Grapefruits	1	1	1	1 ¼
Cereal Bowl	1	1	1	½
Rim/Deep Soup	½	½	½	-
Coffee/Tea Pot	½	½	½	-
Creamer (Pitcher)	½	½	½	-
Service Plate	1 ½	1 ½	1 ½	-

Pakkawood Care & Handling

- **ALWAYS** Dry immediately after washing
- To maintain wood appearance, rub a little food safe oil on the handles monthly
- Dishwasher not recommended
- **NEVER** use any form of chlorine bleach which will discolor
- **NEVER** use pre-soak
- **NEVER** soak in water
- **NEVER** use cleaning solutions containing ammonia or lemon
- **NEVER** use steel wool to clean

S.A.N. Plastic Care & Handling

- **ALWAYS** Prepare a pre-soak solution with warm (not hot) water and a mild detergent specifically designed for plastics.
- **ALWAYS** Follow the duration of the presoak listed on the bottle, (This avoids hazing/chemical ware)
- **ALWAYS** After pre-soaking, rinse drinkware with cool or lukewarm water to remove all detergent residues before placing it in the dishwasher.
- **ALWAYS** Ensure proper par levels- The constant washing can cause warping or clouding
- **ALWAYS** Towel dry with soft cotton buffers or towels and polish glasses for best results.
- **ALWAYS** If serving citrus products, wash and rinse thoroughly after use to prevent discoloration
- **NEVER** use strong alkalis, bleach/chlorine-based cleaners, as they can degrade SAN plastic over time.
- **NEVER** using abrasive sponges or scrubbers to avoid scratching
- **NEVER** soak in water
- **NEVER** use cleaning solutions containing ammonia or lemon
- **NEVER** use steel wool to clean

Chasseur Care & Use

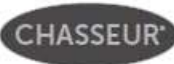

BEFORE USE

- Wash in hot water, rinse and dry thoroughly before first use.
- We recommend pre-seasoning. Even pre-seasoned cast iron can use some extra protection.
- To season your pan, heat it up on the stove top until its hot, then rub a little oil into it and let it cool.
- Clean it after each use.
- Pre-season as needed.

CLEANING & CARE

- Let pans cool before washing in warm water. Soak first in warm water and detergent to remove burnt on food.
- Always use wooden, plastic or silicone utensils, avoid metal.
- Do not tap the edges of the container & never cut food inside the cookware as you risk scratching or damaging the enamel.
- Use non-abrasive nylon scourers.
- Always dry thoroughly before storing.
- Avoid the use of a dishwasher after every use to prolong the longevity of the product.
- Heating in the oven may cause the metal knobs to change color slightly.

ARC CARDINAL ITEMS THAT FIT TRIVETS:

Items that Fit FN976 (Round Trivet)

FN421
Mini Round Matte Black Casserole
0.37 Q (11 7/8 Oz.)

FN422
Mini Round Matte Ruby Casserole
0.37 Q (11 7/8 Oz.)

FN423
Mini Round Matte Black Casserole
0.63 Q (20 1/4 Oz.)

FN424
Mini Round Matte Ruby Casserole
0.63 Q (20 1/4 Oz.)

P0310
Smart Cuisine Creme Brulee Dish
(9 1/2 Oz.)

Items that Fit FN977 (Oval Trivet)

FN417
Round Matte Black Dish
5 7/8" (15 cm)

FN418
Round Matte Black Dish
7 1/8" (18 cm)

Items that Fit FN978 (Oval Trivet)

FN419
Oval Matte Black Dish
7 7/8" x 5 7/8" (20 cm)



GENERAL CARE

- Before first use, and as soon as possible after each use, wash all parts with warm, soapy water. Rinse all parts thoroughly and allow time to dry. Store with stopper off.
- Contents should not be left in the container for longer than 24 hours. As soon as possible after each and every use, wash all parts with warm, soapy water. Rinse all parts thoroughly with clean water. Allow all parts to dry completely prior to next use or storage.
- DO NOT use abrasive soaps, scouring pads, brushes, or other objects to clean inside of container.
- DO NOT use abrasive cleaners or scrubbers to clean outside of product since they may dull finish.
- This product is top-rack dishwasher safe; however, hand washing is recommended as the dishwasher uses harsher detergents and hot water that may affect the appearance of your product.
- Residual liquids, foods, or other contents may become trapped between product components, such as lid parts, container parts, gaskets (flexible band around lid and/or stopper), or straws (if present in the product). Although this product is top-rack dishwasher safe, hand washing is recommended to ensure that these parts of the product are thoroughly cleaned.
- For maximum thermal efficiency, preheat or pre-chill the product just prior to use. Fill with hot/cold tap water, attach lid, let stand 5 to 10 minutes and empty water. After filling container with contents, re-cover with lid to increase thermal efficiency. Never use a microwave, conventional oven, or other heat source for this purpose.

ASSEMBLY & USE

TWIST-AND-POUR STOPPER (IF PRESENT):

1. Remove stopper (A) by twisting counterclockwise.
2. Remove gasket(s) (B and B1 - if present) from underside of stopper (A).
3. Wash all parts separately, then re-assemble. Ensure gasket(s) (B and B1 - if present) are properly seated to minimize leaking.

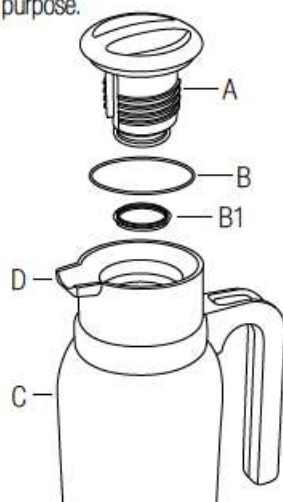

* Image for reference only: actual product may vary

4. Fill container (C) with contents. Do not overfill: Leave space for the stopper (A), to avoid overflow.
5. Replace stopper (A) by twisting clockwise.
6. To pour, twist stopper (A) counterclockwise $\frac{1}{2}$ - 1 turn. Orient product so that pour indicator arrow is pointing in-line with spout (D). Proceed to pour. Note: Stopper does not need to be removed completely to pour contents.
7. Re-tighten stopper (A) by twisting clockwise.

PUSH-BUTTON STOPPER (IF PRESENT):

1. Remove stopper (E) by twisting counterclockwise.
2. To disassemble, lift up on stopper-tab (K) of stopper-cover (L) until completely removed.
3. Depress and twist washer (M) clockwise until it aligns with washer-post (Q). Washer-spring (N) will naturally release washer (M).
4. Remove washer-spring (N).
5. Remove valve-plate (R) and valve-spring (P) by pulling downward on base of valve-plate (R).
6. Remove gaskets (H and I).
7. Wash all parts separately, then re-assemble. Ensure gaskets (H and I) are properly seated to minimize leaking.
8. Fill container (G) with contents. Do not overfill: Leave space for the stopper (E), to avoid overflow.
9. Replace stopper (E) by twisting clockwise. Depress the push-button (O) 2 to 3 times to release pressure.
10. Securely grip handle (J) and press push-button (O).
11. Tilt product and pour contents through spout (F).
12. Bring product to an upright position and release push-button (O).

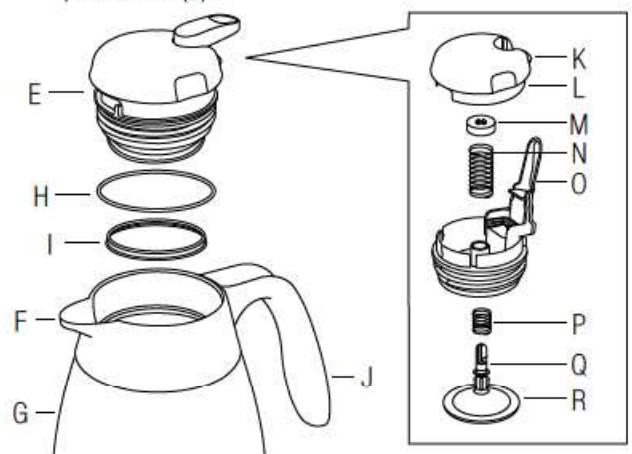

CARE AND USE GUIDE

VACUUM INSULATED STAINLESS STEEL CARAFE

GENERAL CARE

- Before first use, and as soon as possible after each use, rinse all parts with warm, soapy water. Rinse thoroughly with fresh water and allow time to dry. Store with stopper off.
- Contents should not be left in the container for longer than 24 hours. As soon as possible after each and every use, wash all parts with warm, soapy water. Rinse all parts thoroughly with clean water. Allow all parts to dry completely prior to next use or storage.
- DO NOT use abrasive cleaners or scrubbers to clean outside of product since they may dull finish.
- DO NOT use bleach or cleaners containing chlorine on any parts of product.
- HANDWASH ONLY - this product is not dishwasher safe.
- DO NOT immerse or soak in water for prolonged periods of time. Residual liquids, foods, or other contents may become trapped between product components, such as lid parts, container parts, gaskets (flexible band around lid and/or stopper), or straws (if present in the product). Hand washing is recommended to ensure that all parts of the product are thoroughly cleaned.
- For maximum thermal efficiency, preheat or pre-chill the product just prior to use. Fill with hot/cold tap water, attach lid, let stand 5 to 10 minutes and empty water. After filling container with contents, re-cover with lid to increase thermal efficiency. Never use a microwave, conventional oven, or other heat source for this purpose.

PUSH-LEVER LID (IF PRESENT):

1. Remove lid (A) by twisting counterclockwise.
2. Wash all parts separately, then re-assemble. See General Care section above for washing instructions.
 - a. Ensure gaskets (if present) are properly seated to minimize leaking.
3. Fill container with contents. Do not overfill: Leave space for the lid (A) to avoid overflow.
4. Replace lid (A) by twisting clockwise. Depress the push-lever (A1) 2 to 3 times to release pressure.
5. To pour, securely grip handle (B) and press push-lever (A1).
6. Tilt product and pour contents through spout (A2).
7. Bring product to an upright position and release push-lever (A1) to close.

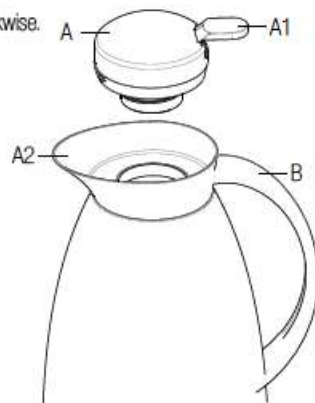

HINGED LID (IF PRESENT):

1. Lift lid (A) by pressing on the hinge lever (A1).
2. Wash all parts. See General Care section above for washing instructions.
3. Before filling, open lid (A) all the way. Fill container with contents.
 - a. Do not overfill: Leave space for the lid (A) to avoid overflow.

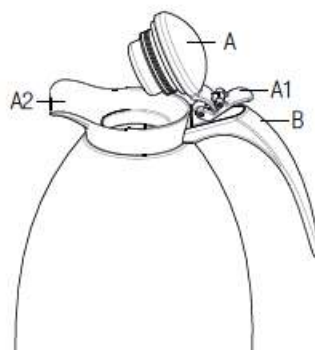

Image for reference only: Actual product may vary.

4. To pour, securely grip handle (B) and press and hold hinge lever (A1). Hinge lever (A1) must be held while pouring to ensure easy flow of contents.
5. Tilt product and pour contents through spout (A2).
6. Bring product to an upright position and release hinge lever (A1).
7. To close, press down on the lid (A) into the lid opening until the lid (A) is secure.
 - a. Hinge lever (A1) may need to be adjusted to better align the lid and lid opening.

CARE AND USE GUIDE

GLASS VACUUM INSULATED CARAFE

EN

GENERAL CARE

- Before first use, and as soon as possible after each use, rinse all parts with warm, soapy water. Rinse thoroughly with fresh water and allow time to dry. Store with stopper off.
- Contents should not be left in the container for longer than 24 hours. As soon as possible after each and every use, wash all parts with warm, soapy water. Rinse all parts thoroughly with clean water. Allow all parts to dry completely prior to next use or storage.
- DO NOT use abrasive cleaners or scrubbers to clean outside of product since they may dull finish.
- DO NOT use bleach or cleaners containing chlorine on any parts of product.
- HANDWASH ONLY - this product is not dishwasher safe.
- DO NOT immerse or soak in water for prolonged periods of time. Residual liquids, foods, or other contents may become trapped between product components, such as lid parts, container parts, gaskets (flexible band around lid and/or stopper), or straws (if present in the product). Hand washing is recommended to ensure that all parts of the product are thoroughly cleaned.
- For maximum thermal efficiency, preheat or pre-chill the product just prior to use. Fill with hot/cold tap water, attach lid, let stand 5 to 10 minutes and empty water. After filling container with contents, re-cover with lid to increase thermal efficiency. Never use a microwave, conventional oven, or other heat source for this purpose.

PUSH-LEVER LID (IF PRESENT):

1. Remove lid (A) by twisting counterclockwise.
2. Wash all parts separately, then re-assemble. See General Care section above for washing instructions.
 - a. Ensure gaskets (if present) are properly seated to minimize leaking.
3. Fill container with contents. Do not overfill: Leave space for the lid (A) to avoid overflow.
4. Replace lid (A) by twisting clockwise. Depress the push-lever (A1) 2 to 3 times to release pressure.
5. To pour, securely grip handle (B) and press push-lever (A1).
6. Tilt product and pour contents through spout (A2).
7. Bring product to an upright position and release push-lever (A1) to close.

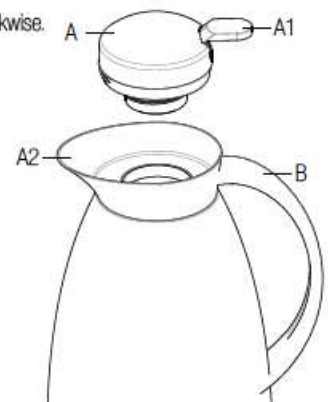

Index

00016147	36229159	7107986, 151	E151394
00187369	3768495	7108084	E151494
0021385, 143	40375147	7108186, 144	E151594
00556260	42258151	7108384	E1907122
01141260	43100156	7108484	E1908161
01158260	43279102	7108685, 137	E278857
01166260	43281102	7109286	E278957
0475786	43319253	7109386, 144	E279057
04900158	43716157	7592689	E356288
0694284	43745161	76495161	E5358150
07134155	43746161	7932085, 143	E5458, 126
0739586	44273156	79736122	E6125172,
0923285, 143	4688856	C0198163	E6127172,
10007123	4697355	C0678165	E6128172,
10291163	4697855	C0790160	E6131172
1187495	4698157	C1320369	E6132172,
12652121, 149	4701757	C1643160	E6133173
1292686	4701957	C2172145	E6134173
14611253	4702657	C3544155	E6136173
1479858, 150	47346123, 147	C3966147	E6137173
15012105	4802458, 135	C5872157	E6138173
17198123	50061253	C8303124, 372	E6141173,
19188147	5081655	C8304124	E7254165
19343156	50998261	C8832124	E7255165
19415159	51257369	CA030141	E769561
19416159	52643157	CA031141	E769661
2086487	53205125	CA504141	E769761
2086587	53214125	CAP01169	E769861
2086687	53224125	CAP02169	E770061, 135
2086787	53232125	CAP04168	E8007257
2086887	5340395	CAP05168	E8792157
2086987	53404160	CAP07169	E9155260
2087187	5366489	CAP09169	E9156260
2087387	53673163	CAP18167	E9157260
2087487	53675163	CAP20167	E9158260
2087587	55878369	CAP28167	E9159260
21053159	5706989	CAP32166	E9298165
22032156	5707089	CAP51166	EB165181
22506252	5728689	D1C08365163	EB182181
22514253	57974252	D1CM5312	EB217181
22522252	57975252	370		EB248181
22530252	58010261	D0129158	EB255181
22712253	58012261	D0130126	EB260181
25263159	58621252	D0575121	EB281181
25269253	6044094	D0616121, 149	EB288181
25275159	6169794	D079556	EB298181
25285253	6169894	D079658, 135	EG105230
25293253	6187595	D202485, 143	EG162229
28891253	62664151	D2443160	EG178230
29337253	64733253	D631589	EG205229
29811161	7107585	D6653162	EG216229
33040163	7107686	D7410257	EG229229
36140253	7107886	D921995	EG243229

84,

EG254 229
 EG267 229
 EG271 229
 EG273 229
 EG292 229
 EG295 229
 EG356 229
 EJ105 230
 EJ162 229
 EJ178 230
 EJ205 229
 EJ216 229
 EJ229 229
 EJ243 229
 EJ254 229
 EJ267 229
 EJ271 229
 EJ273 229
 EJ292 229
 EJ295 229
 EJ318 229
 EJ356 229
 ELG01 305
 EO165 181
 EO182 181
 EO217 181
 EO248 181
 EO255 181
 EO260 181
 EO281 181
 EO288 181
 EO298 181
 EO355 181
 EP105 230
 EP162 229
 EP178 230
 EP205 229
 EP216 229
 EP229 229
 EP243 229
 EP254 229
 EP267 229
 EP271 229
 EP273 229
 EP292 229
 EP295 229
 EP318 229
 EP356 229
 EP777 196
 EQ284 280
 EQ285 280
 EQ286 280
 EQ287 280
 EQ288 280
 EQ289 280

EQ290 280
 EQ291 280
 EQ292 280
 EQ293 280
 EQ294 280
 EQ295 280, 304
 ESK01 304
 EV318 229
 FE644 163
 FF192 246
 FF193 246
 FF194 246
 FF195 246
 FF196 246
 FF198 246
 FF199 246
 FF200 246
 FF201 246
 FF202 246
 FG701 291
 FG704 291
 FG706 291
 FG709 291
 FG726 291, 305
 FG727 268
 FG728 291
 FG729 291
 FH285 217
 FH286 217
 FH287 217
 FH288 217
 FH289 217
 FH608 217
 FH609 217
 FH610 217
 FH611 217
 FH614 217
 FH615 217
 FH621 217
 FJ014 165
 FJ015 165
 FJ016 165
 FJ035 55, 372
 FJ036 55
 FJ060 127
 FJ061 127
 FJ062 127
 FJ063 127
 FJ506 304
 FJ507 304
 FJ508 304
 FJ516 304
 FJ517 304
 FJ611 304
 FJ612 304

FJ701 268
 FJ704 268
 FJ706 268
 FJ708 268
 FJ709 268
 FJ801 280
 FJ804 280
 FJ806 280
 FJ828 280
 FJ829 280
 FJ909 280
 FJ911 280
 FK203 124
 FK258 127
 FK259 127
 FK307 304
 FK364 146
 FK368 146
 FK401 288
 FK404 288
 FK406 288
 FK429 288
 FK492 146
 FK493 146
 FK501 289
 FK504 289
 FK506 289
 FK528 289
 FK529 289
 FK596 167
 FK603 304
 FK639 213
 FK640 213
 FK641 213
 FK642 213
 FK643 213
 FK644 213
 FK645 213
 FK646 213
 FK763 215
 FK764 215
 FK765 215
 FK766 215
 FK767 215
 FK768 215
 FK769 215
 FK770 215
 FK774 215
 FK775 215
 FK777 215
 FK788 227
 FK789 227
 FK790 227
 FK801 270
 FK802 270

FK804 270
 FK806 270
 FK809 270
 FK828 270
 FK829 270
 FK856 160
 FL101 301
 FL104 301
 FL106 301
 FL128 301
 FL129 301
 FL201 287
 FL202 287
 FL204 287
 FL206 287
 FL209 287
 FL211 287
 FL218 287
 FL221 287
 FL227 287
 FL228 287
 FL229 287
 FL337 155
 FL401 295
 FL402 295
 FL404 295
 FL406 295
 FL409 295
 FL418 295
 FL428 295
 FL429 295
 FL470 163
 FL501 275
 FL502 275
 FL504 275
 FL506 275
 FL509 275
 FL528 275
 FL529 275
 FL601 301
 FL604 301
 FL606 301
 FL609 301
 FL628 301
 FL629 301
 FL643 227
 FL644 227
 FL645 227
 FL646 227
 FL647 227
 FL648 227
 FL701 297
 FL702 297
 FL704 297
 FL706 297

FL709	297
FL711	297
FL718	297
FL721	297
FL727	297
FL728	297
FL729	297
FL901	271
FL902	271
FL904	271
FL906	271
FL909	271
FL913	271
FL927	271
FL928	271
FL929	271
FL940	271
FL941	286
FL942	286
FL946	286
FL948	286
FL951	286
FL952	286
FL953	286
FM077	173
FM120	172, 372
FM381	218
FM382	217
FM501	291
FM502	291
FM504	291
FM505	291
FM506	291
FM509	291
FM518	291
FM528	291
FM529	291
FM530	291
FM536	195
FM537	196
FM538	195
FM539	195
FM540	197
FM541	197
FM542	195
FM543	197
FM544	195
FM545	195
FM546	197
FM547	195
FM548	195
FM549	195
FM550	196
FM551	195
FM552	196

FM553	195
FM554	195
FM555	196
FM556	195
FM557	196
FM558	195
FM559	197
FM560	195
FM561	196
FM562	196
FM563	197
FM564	195
FM566	195
FM567	196
FM568	195
FM569	195
FM570	195
FM601	300
FM604	300
FM606	300
FM609	300
FM611	300
FM627	300
FM628	300
FM629	300
FM711	289
FM713	197
FM721	289
FM729	185
FM730	185
FM732	185
FM733	185
FM736	185
FM737	185
FM738	185
FM739	185
FM740	184
FM741	184
FM742	230
FM743	230
FM744	230
FM745	230
FM746	230
FM747	230
FM748	230
FM749	230
FM750	230
FM751	230
FM752	230
FM753	230
FM754	230
FM755	230
FM756	230
FM757	230
FM758	230

FM759	230
FM760	230
FM761	230
FM762	230
FM763	230
FM764	230
FM765	230
FM888	195
FM900	197
FM901	197
FM902	197
FM903	197
FM904	197
FM913	229
FM914	229
FM915	229
FMO05	271
FMO06	304
FMO08	271
FMO12	271
FMO26	271, 304
FN001	200
FN002	200
FN003	200
FN004	200
FN006	200
FN011	200
FN017	201
FN019	201
FN022	201
FN026	201
FN028	201
FN031	201
FN033	201
FN034	201
FN038	201
FN039	201
FN051	201
FN063	201
FN090	173
FN091	173
FN092	173
FN093	173
FN097	196
FN159	43
FN160	43
FN161	43
FN162	43
FN166	43
FN282	231
FN283	231
FN284	231
FN345	329
FN348	333
FN350	335

FN351	331
FN352	331
FN353	331
FN354	331
FN355	331
FN356	331
FN357	343
FN361	344
FN362	344
FN363	345
FN364	345
FN365	345
FN366	345
FN367	345
FN368	344
FN369	343
FN370	343
FN371	339
FN372	340
FN373	347
FN417	357
FN418	357
FN419	357
FN420	357
FN421	351
FN422	351
FN423	351
FN424	351
FN425	351
FN426	351
FN427	351
FN428	351
FN429	355
FN430	355
FN431	353
FN432	353
FN433	353
FN434	355
FN435	355
FN436	355
FN437	353
FN438	353
FN441	347
FN442	347
FN443	347
FN444	347
FN445	347
FN446	347
FN447	347
FN448	347
FN454	230
FN455	230
FN493	191
FN494	191
FN495	191

FN496	191
FN497	191
FN498	191
FN499	191
FN500	191
FN501	191
FN502	191
FN503	191
FN504	191
FN505	191
FN506	191
FN507	191
FN508	191
FN509	203
FN510	203
FN511	203
FN512	203
FN513	203
FN514	203
FN516	203
FN681	298
FN686	298
FN687	298
FN688	298
FN689	298
FN690	298
FN692	298
FN694	298
FN695	298
FN727	304
FN808	196
FN809	196
FN827	184
FN828	184
FN876	179
FN877	179
FN878	179
FN879	179
FN880	179
FN881	179
FN882	179
FN883	179
FN884	179
FN885	179
FN897	179
FN898	179
FN899	179
FN922	179
FN923	179
FN924	179
FN928	183
FN929	183
FN930	183
FN931	183
FN932	183

FN935	183
FN940	184
FN941	184
FN942	184
FN943	185
FN946	185
FN949	351
FN950	351
FN951	351
FN976	357, 378
FN977	357, 378
FN978	357, 378
FN995	272
FN996	272
FN997	272
FN998	272
FP001	272
FP012	317
FP016	317
FP017	317
FP018	317
FP019	317
FP020	317
FP021	315
FP022	315
FP023	315
FP024	315
FP025	315
FP026	315
FP027	315
FP028	315
FP029	324
FP030	324
FP031	324
FP038	313
FP039	313
FP041	313
FP042	313
FP043	313
FP044	313
FP045	313
FP046	313
FP047	313
FP048	313
FP049	313
FP050	323
FP051	323
FP052	323
FP053	323
FP054	322
FP055	322
FP056	322
FP057	320
FP058	316
FP059	324

FP060	316
FP061	316
FP062	322
FP063	316
FP064	319
FP065	319
FP066	319
FP067	322
FP068	322
FP085	183
FP086	183
FP087	183
FP088	183
FP089	183
FP090	183
FP091	185
FP092	185
FP111	184
FP112	184
FP117	296
FP119	296
FP120	296
FP121	296
FP122	296
FP124	296
FP130	227
FP131	227
FP132	227
FP133	227
FP134	227
FP135	227
FP167	304
FP168	304
FP171	193
FP172	193
FP173	193
FP174	193
FP175	193
FP176	193
FP177	193
FP178	193
FP179	189
FP180	189
FP181	189
FP182	187, 189
FP183	189
FP184	189
FP185	189
FP186	189
FP187	189
FP188	167
FP189	189
FP190	167
FP191	189
FP193	168

FP195	169
FP196	168
FP197	168
FP198	166
FP228	304
FP235	237
FP236	237
FP237	237
FP238	237
FP239	237
FP240	237
FP241	237
FP242	237
FP243	237
FP244	237
FP245	237
FP246	237, 241
FP247	237
FP248	237
FP249	237
FP250	237
FP251	237
FP252	237
FP253	237
FP254	237
FP255	237
FP256	237
FP257	237
FP258	237
FP259	237, 241
FP260	237
FP261	237
FP262	237
FP263	237
FP264	237
FP265	237
FP266	237
FP267	237
FP268	237
FP269	237
FP270	237
FP271	237
FP272	237
FP273	237
FP274	324
FP275	324
FP277	296
FP278	296
FP279	296
FP280	296
FP286	237
FP287	237
FP288	237
FP303	33, 140
FP305	211

FP306	211
FP307	211
FP308	211
FP309	211
FP310	211
FP311	211
FP312	211
FP313	211
FP314	211
FP315	243
FP316	243
FP317	243
FP318	243
FP320	115, 149, 161
FP321	115, 149
FP322	275
FP323	275
FP324	275
FP325	275
FP326	275
FP331	163
FP332	115, 167
FP349	363
FP350	363
FP351	363
FP357	64
FP359	218
FP361	223
FP362	223
FP363	223
FP364	223
FP365	223
FP366	223
FP367	223
FP368	223
FP369	223
FP370	223
FP373	33, 148
FP374	33
FP375	33
FP381	321
FP382	321
FP383	321
FP384	235
FP385	235
FP386	235
FP387	235
FP388	235
FP393	235
FP394	235
FP395	235
FP398	235
FP399	235
FP400	235
FP401	235

FP402	235
FP403	235
FP408	235
FP409	235
FP410	235
FP413	235
FP414	235
FP415	235
FP416	235
FP417	235
FP418	235
FP423	235
FP424	235
FP425	235
FP428	235
FP430	365
FP431	364
FP432	364
FP433	364
FP439	233
FP440	233
FP444	233
FP445	233
FP446	233
FP447	233
FP448	233
FP449	233
FP450	233
FP452	233
FP453	233
FP458	233
FP459	233
FP460	364
FP461	364
FP462	365
FP463	365
FP464	239
FP465	239
FP466	239
FP467	239
FP468	239
FP469	239
FP470	239
FP471	366
FP472	366
FP473	368
FP474	278, 279
FP475	278, 279
FP476	368
FP477	278, 279
FP478	278, 279
FP479	278, 279
FP480	279
FP481	278
FP482	278

FP483	278
FP484	278
FP486	278
FP487	299
FP488	299
FP489	299
FP490	299
FP491	299
FP493	299
FP494	281
FP495	281
FP496	325
FP497	325
FP498	325
FP499	281
FP500	325
FP501	281
FP502	281
FP503	325
FP504	281
FP505	325
FP506	290
FP507	290
FP508	290
FP509	290
FP510	290
FP512	366
FP513	366
FP514	366
FP515	367
FP516	290
FP518	367
FP519	290
FP520	367
FP521	368
FP522	367
FP523	289
FP524	289
FP525	367
FP526	289
FP527	367
FP528	289
FP529	289
FP530	367
FP531	289
FP532	289
FP533	289
FP534	289
FP535	290
FP536	290
FP537	290
FP538	290
FP539	290
FP540	290
FP541	290

FP542	290
FP543	299
FP544	299
FP545	299
FP546	299
FP547	299
FP548	299
FP549	299
FP550	299
FP551	273
FP552	273
FP553	273
FP554	273
FP555	273
FP557	273
FP558	281
FP559	281
FP560	281
FP561	281
FP562	281
FP564	281
FP565	273
FP566	273
FP567	273
FP568	273
FP569	273
FP570	273
FP571	305
FP572	305
FP573	305
FP574	305
FP575	305
FP576	290
FP614	187
FP615	187
FP616	187
FP617	187
FP618	187
FP619	219
FP631	31
FP632	31
FP633	31, 134
FP642	278
FP643	278
FP644	278
FP645	278
FP646	278
FP647	278
FP648	278
FP649	299
FP650	299
FP651	299
FP652	281
FP653	281
FP654	290

FP655	290
FP656	290
FP664	290
FP665	290
FP666	281
FP667	281
FP668	281
FP669	299
FP670	299
FP671	299
FP672	273
FP673	273
FP675	185
FP678	31
FP683	116
FP684	116
FP685	187
FP686	187
FP693	321
FP694	321
FP699	366
FP700	241, 368
FP701	279
FP702	279
FP703	279
FP704	279
FP705	279
FP706	279
FP715	320
FP723	319
FP724	297
FP725	297
FP728	297
FP729	297
FP730	297
FP731	297
FP732	294
FP733	294
FP734	294
FP735	294
FP736	294
FP737	294
FP738	294
FP739	294
FP750	235
FP751	235
FP752	235
FP753	235
FP754	235
FP755	235
FP756	235
FP757	235
FP758	235
FP759	235
FP765	241

FP766	241
FP767	241
FP768	241
FP769	241
FP771	241
FP772	241
G0036	67
G2562	117
G2639	147
G2712	260
G3322	67, 372
G3323	67, 372
G3367	65, 148
G3368	65, 372
G3570	58, 154
G3573	58, 154
G3611	122
G3658	59, 372
G3659	59, 148
G3666	59, 148
G3674	59
G3745	247
G3751	247
G3752	247
G3765	247
G3960	156
H0736	94
H2090	73, 137
H2317	73
H2318	73
H3008	99
H3032	99
H3089	99, 156
H3607	251
H3608	251
H3609	251
H3610	251
H3611	251
H3612	251
H3615	251
H3856	99, 156
H3858	99
H4870	124
H5057	147
H5169	99
H8466	80
H9211	159
HB001	185
HB002	185
HB102	184
HB165	183
HR182	183
HB217	183
HB248	183
HB253	183

HB255	183
HB260	183
HB281	183
HB288	183
HB298	185
HB324	183
HB355	185
HB634	184
HB778	184
HB867	184
HBL00	185
HBL01	185
HBL11	183
HBL16	183
HBL18	183
HBL21	183
HBL24	183
HBL25	183
HBL26	183
HBL28	183
HBL29	185
HBL35	185
HBL38	183
HG001	185
HG002	185
HG102	183
HG112	183
HG165	183
HG182	183
HG217	183
HG248	183
HG253	183
HG255	183
HG260	183
HG281	183
HG288	183
HG298	185
HG324	183
HG355	185
HG650	183
HG725	183
HG867	183
HG975	183
HG978	183
HGC11	185
HGC13	185
HGD10	183
HGD11	183
HGR11	185
HGR13	185
HI102	183
HI111	183
HI113	185
HI145	185
HI156	185

HI227	185
HI650	183
HI725	183
HI867	183
HI975	183
HI978	183
HIC11	185
HIC13	185
HID10	183
HID11	183
HIR11	185
HIR13	185
HL001	185
HL002	185
HL165	183
HL182	183
HL217	183
HL248	183
HL253	183
HL255	183
HL260	183
HL281	183
HL288	183
HL298	185
HL355	185
HN001	185
HN002	185
HN113	183
HN165	183
HN182	183
HN217	183
HN248	183
HN253	183
HN255	183
HN260	183
HN281	183
HN288	183
HN298	185
HN317	183
HN355	185
HND63	184
HND77	184
HNW10	184
HNW86	184
HS001	168
HS002	168
J0226	260
J0232	260
J0825	157
J0856	260
J1478	80
J2605	102
J2610	102
J2611	102
J3811	369

J4089 156
 J4094 103, 372
 J4096 103
 J4097 103
 J4099 103
 J4101 103
 J4102 103
 J4103 103
 J4104 103
 J4106 156
 J4238 121
 J8742 39
 J8743 39
 J8821 156
 J8907 39, 135
 J8908 39, 135
 J9014 39
 L0371 85, 137,
 141
 L0571 56, 370
 L2356 65
 L2369 59
 L2370 59
 L2609 45
 L2761 45
 L2762 45, 135
 L2804 257
 L2805 256
 L2808 257
 L2810 256
 L3678 45, 134,
 140
 L3963 164, 372
 L3965 164
 L4212 164
 L4257 164
 L4865 , 126
 L5216 99
 L5217 99
 L5633 49
 L5635 49
 L5636 49
 L5637 49, 372
 L5638 49
 L5640 50, 135
 L5641 50, 134, 140
 L5642 51
 L5754 51
 L5755 51
 L5756 51, 148
 L5757 51, 148
 L5758 51, 148
 L6119 151, 160
 L6247 164
 L6689 261

L6850 253
 L7254 115, 161
 L7255 115
 L7256 115
 L7844 102
 L8110 65
 L8677 67
 L8970 156
 M0090 260
 MB201 295
 MB202 295
 MB204 295
 MB220 295
 MB246 286
 MB247 286
 MB248 286
 MB249 286
 MB250 286
 MB251 286
 MB252 286
 MB253 286
 MB254 286
 MB296 271, 297
 MB297 271, 297
 MB298 271
 MB300 271
 MB301 297
 MB302 271
 MB303 271
 MB304 307
 MB305 307
 MB309 307
 MB320 307
 MB321 271, 297
 MB322 270
 MB323 270
 MB324 270
 MB326 270
 MB327 270
 MB329 270
 MB331 270
 MB337 270
 MB341 270
 MT002 169
 MT004 168
 MT011 168
 MT051 166
 MT849 167
 MT850 167
 N0512 109
 N0513 109
 N0520 109
 N0521 109
 N0523 109
 N0524 109, 149

N0527 109
 N0528 109
 N0529 109, 147
 N0530 109
 N0531 109, 149
 N0834 , 66
 N1738 39
 N1739 45
 N2608 260
 N2644 158
 N2760 144
 N4080 163
 N4742 45
 N4907 79
 N5082 78, 137
 N5163 79
 N5368 45, 154
 N5812 117
 N5828 117
 N5834 147
 N5993 79
 N5994 79
 N5995 79, 149
 N6216 143
 N6374 150
 N6393 252
 N6643 121
 N6815 58, 140
 N6831 58, 142
 N7945 260
 N8172 150
 N8212 150
 N8901 105
 N9360 256
 N9361 256
 N9362 256
 N9364 257
 N9365 257
 N9395 257
 N9411 256
 N9696 48
 N9710 49
 N9711 51, 154
 OL166 169
 OL167 166
 P0089 51, 154
 P0112 57
 P0310 257
 P0447 256
 P0776 85
 P0777 85
 P0887 257, 260
 P1122 256
 P1139 256
 P1470 115

P3008 157
 P3882 58, 142
 P3946 251
 P3967 253
 P3972 252
 P4188 118, 149
 P6284 124, 372
 P8494 81
 P8495 149
 P8496 149
 P8499 81
 P8500 81, 149
 P8782 77, 155
 P8790 77
 P8793 76, 137
 P8794 77
 P8795 115, 143
 P8796 115, 141
 P8821 115, 144
 P9067 118, 149
 P9771 257
 P9772 257
 P9773 257
 Q1069 48, 370
 Q1151 43, 47, 135
 Q1325 113, 143
 Q1774 105
 Q2233 101
 Q2234 101
 Q2504 129
 Q2505 129
 Q2517 129
 Q2518 129
 Q2536 129
 Q2537 129
 Q2538 129
 Q2539 129
 Q2540 129
 Q2542 129
 Q2750 101
 Q2751 101
 Q2967 101
 Q3700 101
 Q3701 101
 Q3702 50, 140
 Q4025 164
 Q4026 164
 Q4033 164
 Q4340 68
 Q4353 148
 Q4354 69, 148
 Q4358 69
 Q5761 121, 147
 Q7781 121
 Q7785 50, 134, 140

Q7932 115, 143
 Q8201 113
 Q8701 113
 Q8947 118
 Q9062 53
 Q9064 53
 Q9080 53, 134
 R0020 162
 R0735 247
 R0736 247
 R0738 247
 R0741 247, 372
 R0801 218
 R0803 218
 R0805 218
 R0806 218
 R0807 219
 R0809 218
 R0811 218
 R0817 219
 R0819 219
 R0830 219
 R0833 219
 R0835 219
 R0839 219
 R0840 219
 R0850 219
 R0851 219
 R0852 219
 R0882 219, 223
 R0901 220
 R0902 220
 R0903 220
 R0904 220
 R0905 220
 R0906 220
 R0907 220
 R0908 221
 R0917 221
 R0918 221
 R0919 221
 R0926 221
 R0928 221
 R0929 221
 R0931 221
 R0932 221
 R0933 221
 R0947 221
 R0950 221
 R0959 221
 R0960 221
 R0968 221
 RBB02 169
 RBB06 169
 RBBR7 169

RBDG3 169
 RBP04 169
 RBR09 169
 RBW06 169
 RBY03 169
 S0602 209
 S0603 209
 S0604 209
 S0606 209
 S0628 209
 S0630 209
 S0633 209
 S0638 209
 S1501 207
 S1502 207
 S1503 207
 S1504 207
 S1506 207
 S1507 207
 S1508 207
 S1509 207
 S1512 207
 S1517 207
 S1518 207
 S1521 207
 S1528 207
 S1530 207
 S1533 207
 S1534 207
 S1535 207
 S1538 207
 S1550 207
 S1916 209, 223
 SCP99 302
 SCR98 302
 SOL01 298
 SOL02 294, 298
 SOL04 298
 SOL05 294, 298
 SOL06 294, 298
 SOL08 298
 SOL10 298
 SOL11 298
 SOL13 298
 SOL20 298
 SOL28 298
 SOM01 294
 SOM02 294
 SOM04 294
 SOM05 294
 SOM06 294
 SOM10 294
 SOM28 294
 T0418 272, 306
 T0421 306

T0422 306
 T0426 272, 304
 T1801 282
 T1802 282
 T1804 282
 T1805 282
 T1806 282
 T1808 282
 T1809 282
 T1811 282
 T1813 307
 T1816 307
 T1817 307
 T1818 307
 T1819 307
 T1821 307
 T1822 307
 T1824 307
 T1825 307
 T1826 305
 T1828 282
 T1829 282
 T1901 283
 T1902 283
 T1904 283
 T1906 283
 T1911 283
 T1928 283
 T1929 283
 T3601 279
 T3602 279
 T3604 279
 T3606 279
 T3611 279
 T3621 279
 T3627 279
 T3628 279
 T3629 279
 T4701 272
 T4702 272
 T4704 272
 T4706 272
 T4709 272
 T4711 272
 T4727 272, 306
 T4728 272
 T4729 272
 T4801 287
 T4804 287
 T4806 287
 T4809 287
 T4828 287
 T4829 287
 T4901 288
 T4902 288

T4904 288
 T4905 288
 T4906 288
 T4908 288
 T4909 288
 T4911 288
 T4927 288
 T4928 288
 T4929 288
 T5101 269
 T5102 269
 T5104 269
 T5105 269
 T5106 269
 T5109 269
 T5111 269
 T5121 269
 T5127 269
 T5128 269
 T5129 269
 T5201 269
 T5204 269
 T5206 269
 T5209 269
 T5221 269
 T5227 269
 T5228 269
 T5229 269
 T5401 268
 T5402 268
 T5404 268
 T5405 268
 T5406 268
 T5408 268
 T5409 268
 T5411 268
 T5427 268
 T5428 268
 T5429 268
 T7801 283
 T7802 283
 T7804 283
 T7806 283
 T7828 283
 T7829 283
 T8001 300
 T8002 300
 T8004 300
 T8006 300
 T8008 300
 T8009 300
 T8011 300
 T8028 300
 T8029 300
 U1010 37

U1011	37
U1012	37
U1013	37
U1032	37, 150, 372
U1033	37
U1051	37, 135
V0391	41
V0410	162
V1171	41, 140
V1483	41
V1536	255
V1537	255
V1538	255
V1539	255
V1540	255
V1653	255
V2125	77
V2128	76, 370
V2159	257
V2620	63
V2696	41
V2697	41, 134
V2760	77, 143
V2761	77, 141
V2821	63
V2822	63
V2823	63, 135
V2910	115, 147
V3469	121, 149
V3470	105
V3471	157
V3472	121
V3473	105
V3475	121
V3476	121, 149
V3604	45
V3870	117
V3871	105
V3872	155
V3873	155
V3874	137, 141
V4024	77
V4025	77, 143
V4138	97
V4139	97
V4140	97
V4222	77, 145
V5794	58, 150
V5926	122
V5927	122
V5985	122
V5996	115
V5998	115
V6189	47
V6190	47

V6191	47
V7429	261
V7445	157
V7462	94
V7483	95
V7527	94
V7529	94
V7535	94
V7636	92, 93
V7637	92, 93
V7638	93
V7639	93
V7655	260
V8248	147
V8704	92, 93
V8705	92, 93
V8706	93
V8707	93
V8710	92, 93
V8711	92, 93
V8712	93
V8713	93
V8924	102
V8953	161
V8954	161
V8956	161
V9346	157
V9571	91
V9572	91
V9573	91
V9574	91
V9689	162
X0154	94
X0422	94
X0433	91
X0434	91
X0633	137

Plating/Beverage Artists

Chef Dennis MacDonald, @dennis.eats

Chef & Sommelier® Eternity Plus, *featured on page 194*
Cover plating

Valeria Pinto @VibrantValeria, RezDóra, New York, NY

Arcoroc® Candour Azure, *featured on page 212*

Eric Levine, Farmingdale, NJ

Arcoroc® Rondo, *featured on page 206*
Arcoroc® Horizon, *featured on page 208*

Spoonabilities, Miami, FL

Arcoroc® Athena, *featured on page 210*
Arcoroc® Athena and Black Oak, *featured on page 266*

Miami Chef Studios, Miami, FL

Chasseur, *featured on page 350*

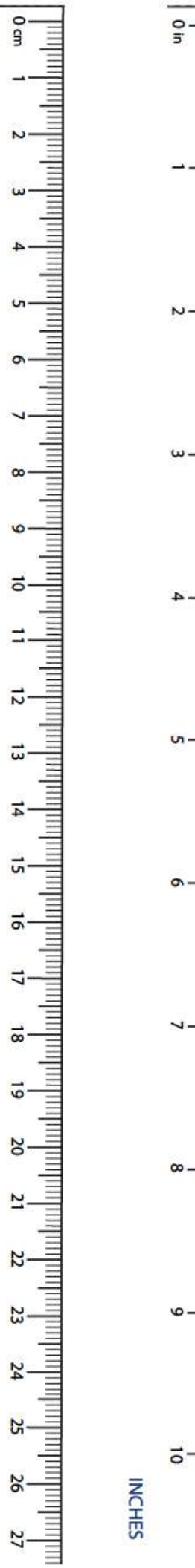



arc
cardinal

2025/2026 PORTFOLIO

ARCCARDINAL.COM

45A COMMERCE WAY TOTOWA, NJ 07512

973-628-0900 | CARDINALSALES@ARC-INTL.COM